

Designing Woodland Roads

J. Garland

Are you, a woodland owner, expected to perform certain engineering functions that road engineers typically perform in designing roads? The answer is, “Yes—in part.” This publication does not pretend to make professional engineers of woodland owners. However, it does provide a basis for understanding the process of designing woodland roads.

By using your intimate knowledge of your property, you can contribute special expertise to road design, such as in reconnoitering the route and locating control points. Furthermore, by understanding the process of designing roads, you can better identify when professional services are needed. Also, if you contract for services, you should be better able to supervise your contractors.

Designing woodland roads has two elements: developing the specifications for constructing the road, and the field layout and location that guide road construction. The degree to which woodland owners become involved in road design for their properties will vary according to individual interests and backgrounds as well as the complexity of roadbuilding.

You can reduce the high cost of road construction by effective road design. Road design efforts, even by paid professionals, are small costs in relation to construction costs. Some woodland owners design and build their own roads when the small scale of the project and simple situations do not justify more expanded design efforts.

Reconnaissance

Road reconnaissance consists of looking at your property with a road plan in mind. You know your property as well as anyone, and with some training, you can identify where roads should or should not be built.

Before your on-the-ground reconnaissance, looking at aerial photographs, maps, soil survey information, or even a simple sketch can help focus the route location effort. A major benefit of these activities is to assure that the proposed road fits the overall plan for providing access to the property. Even if you’re planning only a short road, it must fit the overall plan.

John J. Garland, Extension timber harvesting specialist, Oregon State University.

Control points

A major “recon” activity is to locate control points for the road. These are special areas on your property where it’s desirable to build a road or where it’s wise to avoid locating a road. The following are control points.

Landings Potential landing areas are moderately flat locations along the route

where trucks can be loaded. In cable logging, the yarding machine will set up here to yard logs from the surrounding area. In ground-based logging, logs are skidded to a landing for loading, but the landing location must also balance the skidding distances for the machines.

Saddles Ridgetop roads almost always

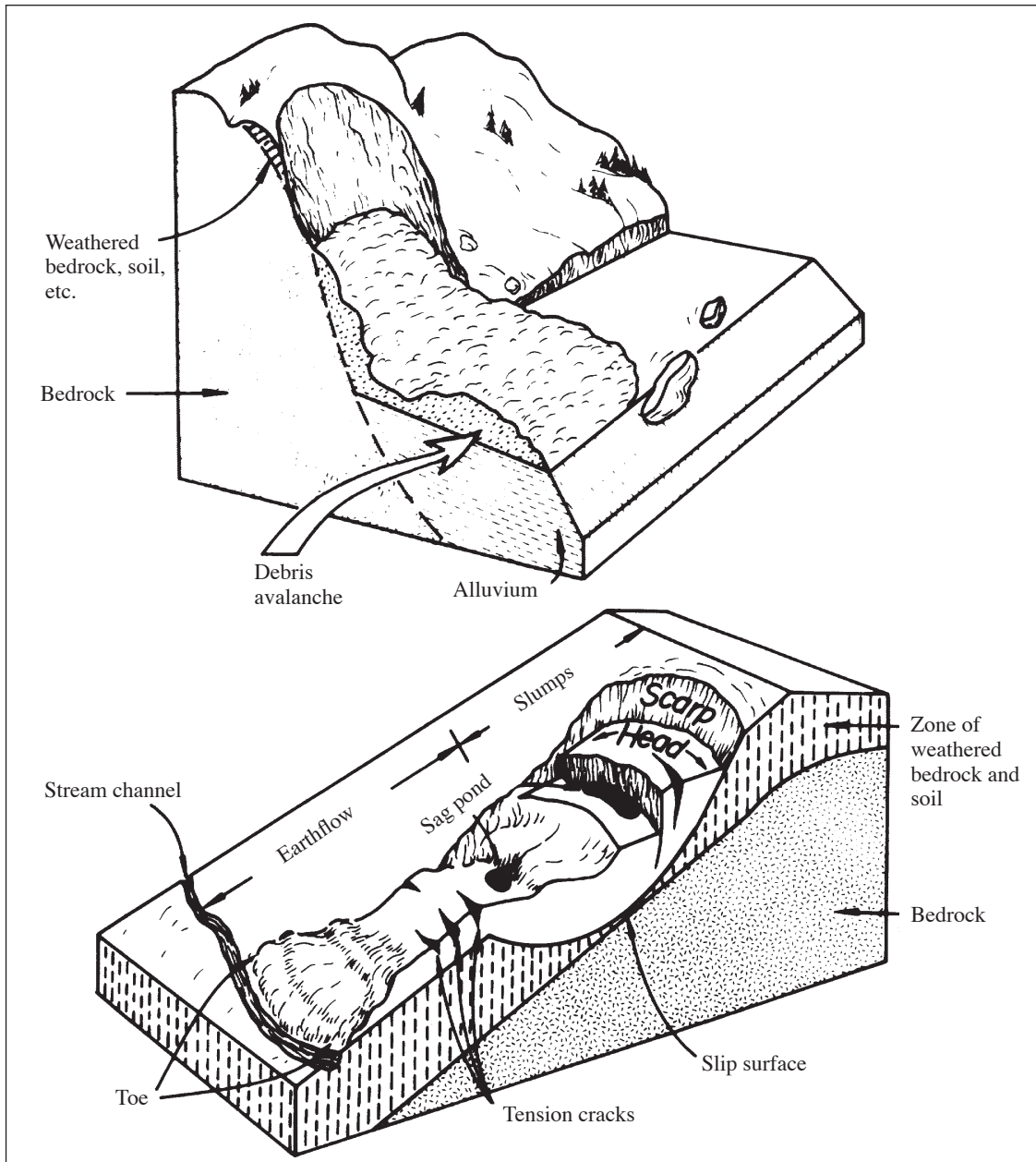

Figure 1.—Indicators of slides and slumps. *Top:* Debris avalanches and flows typically occur on steep slopes with shallow soils overlying an impermeable layer. Indicators include areas of previous slides; steep areas lacking vegetation; and granular, low-cohesion soils that have a low to moderate clay content.

Bottom: Slumps and earthflows frequently occur together, creating such landform features as sag ponds, tension cracks, and headwall scarps. Indicators include tipped, jackstrawed, or pistol-butt-shaped trees; poor drainage in deep, clay-rich soils; hummocky topography; and areas of past failures.

pass through saddles—low points along the top of a ridge. When roads are in saddles, both sides of the ridge system may be reached. Wide saddles also make good landings.

Benches Flat areas between slopes are good places to aim when locating roads. Benches are natural breaks where easy road construction and good landing locations often are available.

Steep hillsides and rock outcrops Generally, roads on steep hillsides with obvious or expected rock outcrops are expensive and difficult to construct. However, excavating a road through an outcrop can be beneficial when the outcrop provides surfacing material.

Slumps and slides Roads on unstable terrain are problems during construction; they may trigger more massive problems of slope stability. Indicators of slumps and slide are in Figures 1 and 2.

Wet spots, swamps, and springs Avoiding road locations that expose sub-surface water or that cross wetlands will avoid future maintenance problems.

Potential stream crossings Stable locations for stream crossings depend on the type of crossing and the ease of construction. A ford requires a shallow stream bed with a solid bottom, whereas a bridge requires a narrow channel with stable stream banks.

Sharp ridges and “V” draws Construction problems are likely when sharp ridges must be heavily excavated to create a stable roadbed. Also, crossing V-shape draws causes problems because the excavated material can slide away under the roadway.

Areas for excavation waste In addition to other control points, it’s useful to identify benches or other stable, flat areas where you can dump excess excavation.

The next step in road reconnaissance is to connect the desirable control points with trial ribbon lines. These are lines of ribbons

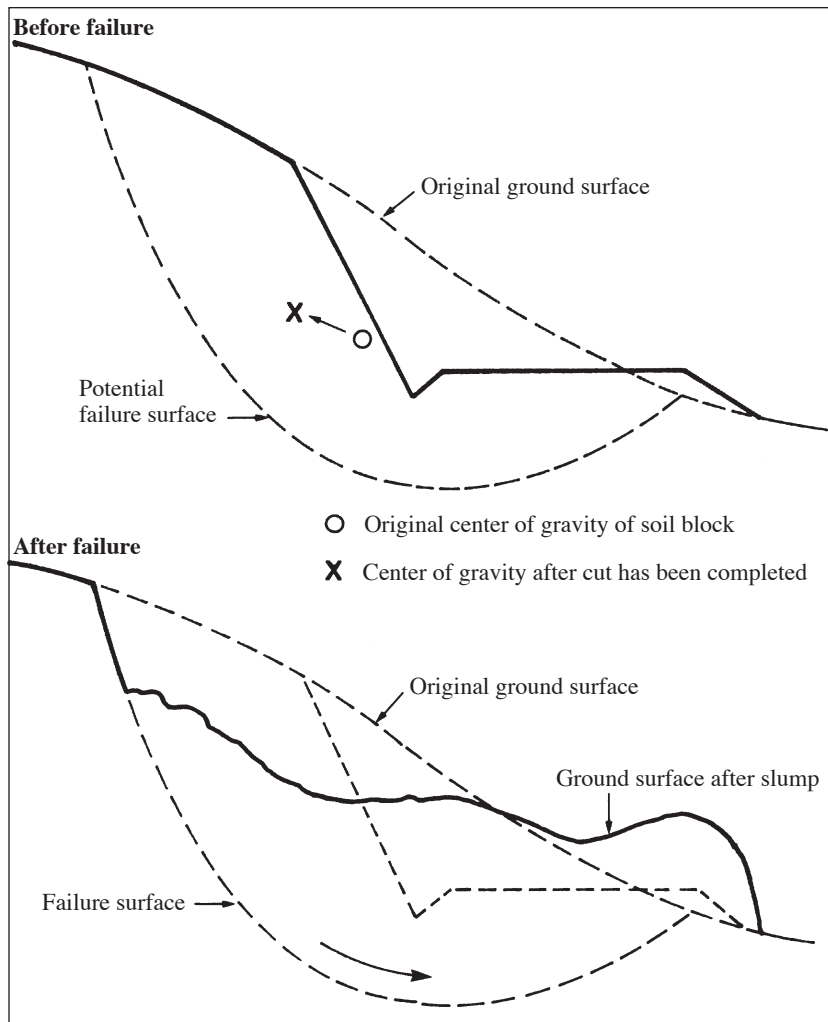

Figure 2.—The effects of improper road location on a slump area.

hung in trees and shrubs at the expected grades and approximate location of the road. In simple situations, you may build roads from these ribbon lines. For more complex situations, the trial location provides a rough guide for collecting detailed information to use in design and calculations.

Trial locations are subject to revision and modification even after you begin construction. If you encounter problems (e.g., hidden rock), it’s far better to revise the road location than to incur extraordinary costs or initiate environmental problems.

The major reason for intensive reconnaissance is to minimize construction cost with designs that best avoid environmental problems. Roads too close to streams, roads that trigger mass failures and landslides, and roads that cross streams improperly often are the result of a poor recon effort. Once you establish a trial location, it can

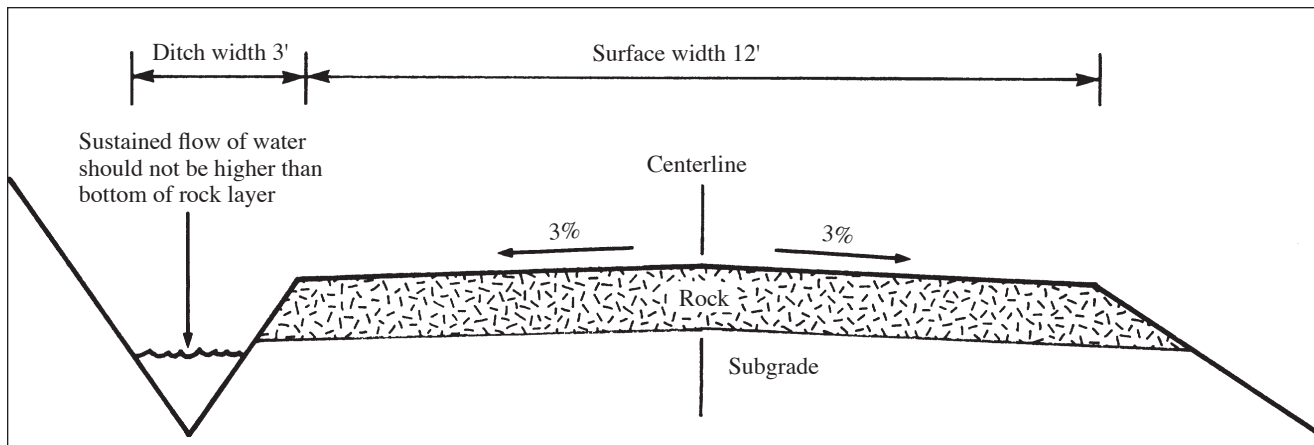

Figure 3.—Crowned road cross-section.

be helpful to contact the forest practices forester of the Oregon Department of Forestry for advice on environmental questions and legal requirements.

Road Geometry

You can build roads in a variety of shapes. Their surface shapes and characteristics depend on management objectives and the terrain. Figures 3–5 show some road shapes.

Crowned roads

Roads with the center elevated to drain water off half the road to the outside and half the road to an inside ditch are called *crowned roads* (Figure 3). This design is the most common road surface because the running surface, if maintained, quickly drains water off the road.

The system of ditches and cross-drains maintains the greatest degree of control over the water. The slope of the crown can be 1 to 3 percent to drain the water off the road or to the ditch.

In an area of frequent and intense rains, design crowned roads with ditches and frequent cross-drains to handle the rain. Properly maintaining the road surface and ditches is critical to their effectiveness.

Inslope roads

Roads that have a slope across the running surface toward the cutbank and do not have a constructed ditch are termed *inslope*

roads. Use these road sections when it's impractical to maintain a ditch. Build cross-drains for inslope roads as pitchouts or rolling dips (see Figure 4) so that the entire road surface handles the rain.

On roads with steep grades—10 to 15 percent—the slope across the road must be 1 to 3 percent higher than the travel grade; otherwise, water will drain down the road surface rather than to the inside. Inslope roads on steep grades may present traction problems when combined with the slope across the surface. Inslope roads are more effective on gentle grades.

You need to space cross-drains closely enough that they can handle the runoff. They must be large enough to direct water across the road to the outside but not so large that they present obstacles to vehicles, especially lowboys used to haul equipment into the area.

Outslope roads

A road that drains water to the outside across its entire surface is an *outslope road* (Figure 5). Because water is not collected and controlled, the outslope grade across the road must be enough to keep the runoff draining to the outside. Furthermore, you must maintain the surface because no cross-drains are available if a rut forms in the road surface.

Ridgetops with gentle grades are candidates for outslope roads. These roads may be more effective in snow areas because they can handle the snowmelt (if main-

(continued on page 6)

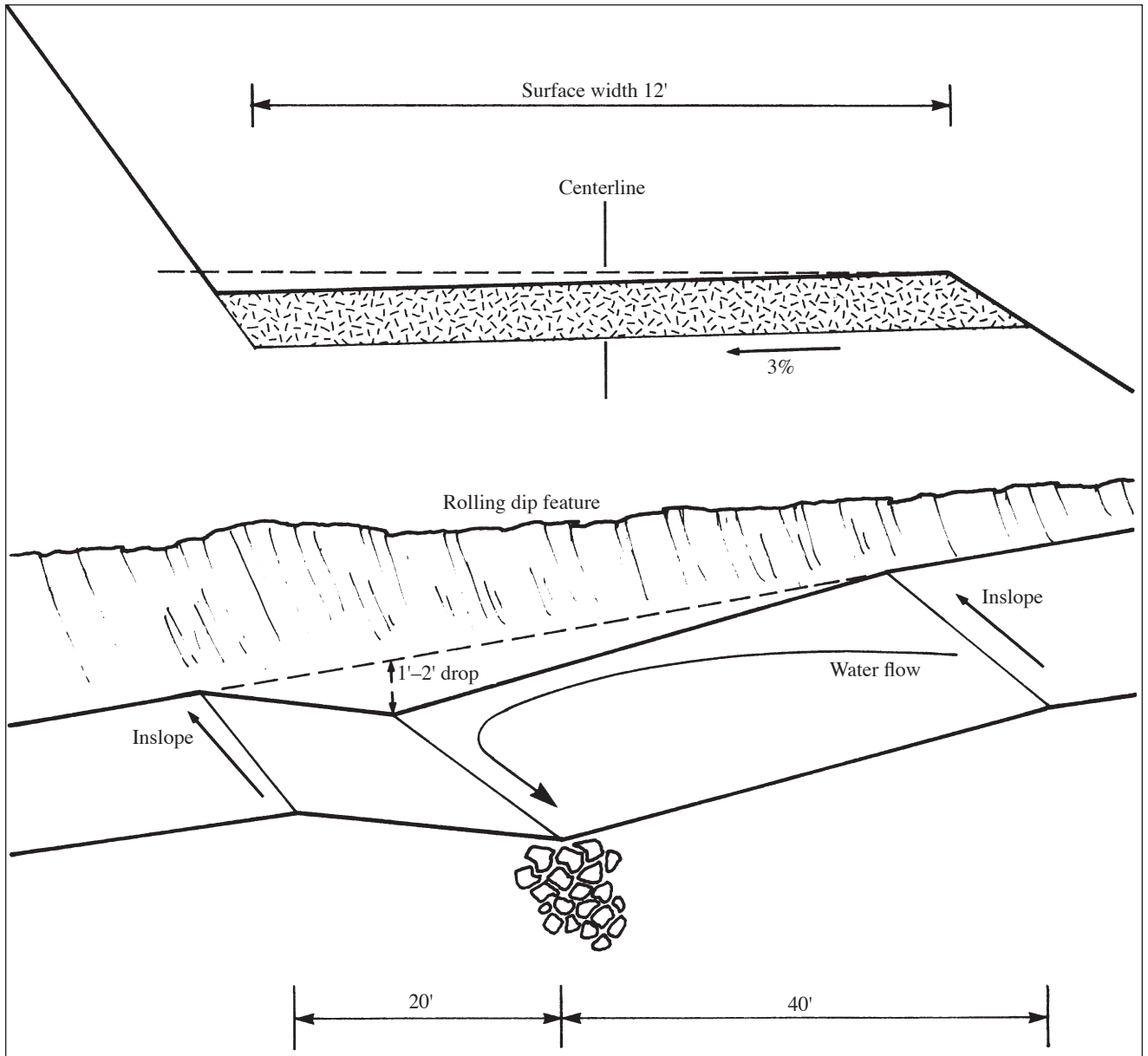

Figure 4.—Inslope road cross-section.

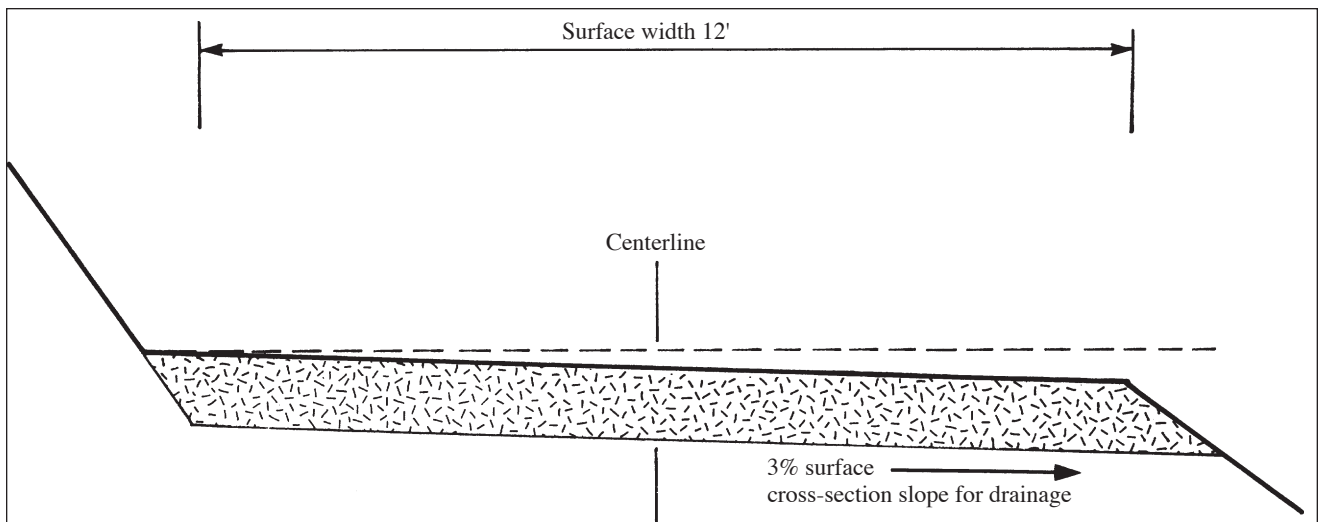

Figure 5.—Outslope road cross-section.

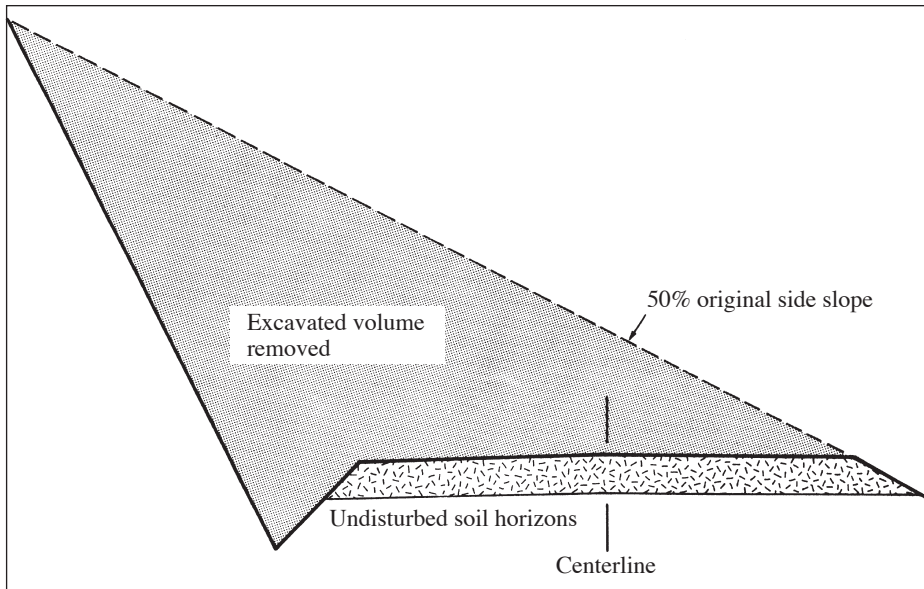

Figure 6.—Full-bench road cross-section.

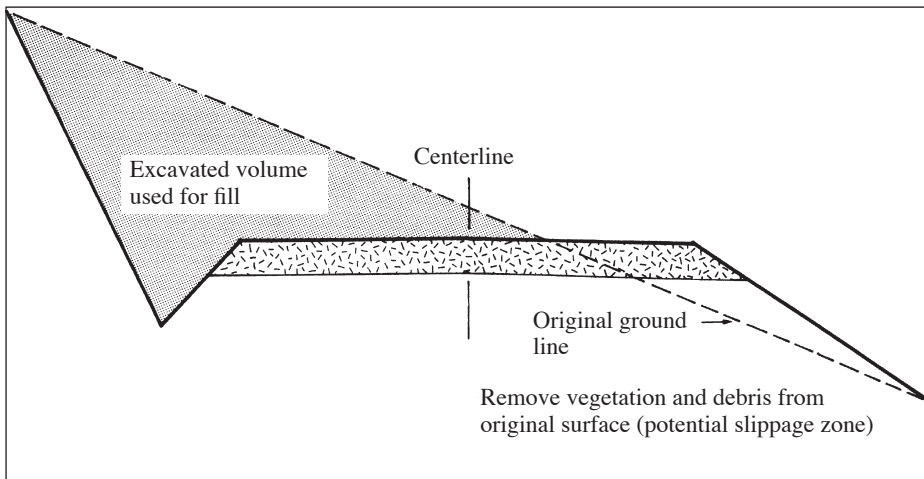

Figure 7.—Road cross-section with partial fill.

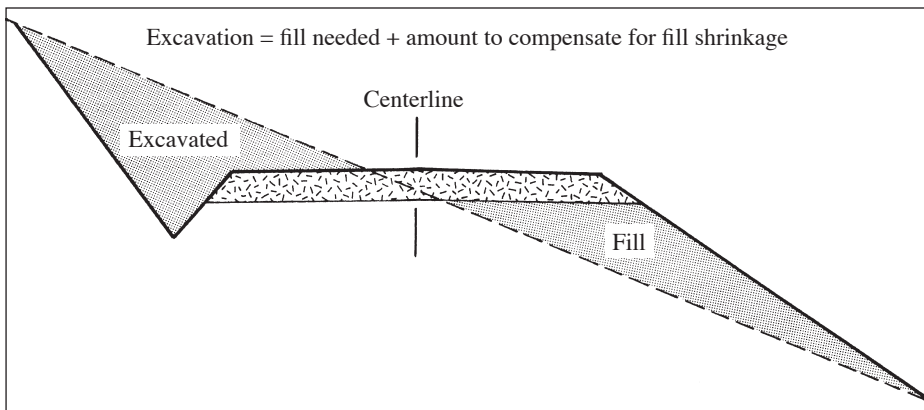

Figure 8.—Balanced road cross-section on gentle slope.

tained before snowfall). On steep grades, outslope roads have the same kinds of problems as inslope roads (see page 4).

Full-bench roads and balanced roads

Depending on terrain conditions, woodland roads are mixtures of cut-and-fill construction (Figures 6–9). You can cut the road surface from stable and undisturbed soil horizons or build it entirely from fill material.

Full-bench roads (Figure 6) usually are built on slopes of over 65 percent. The entire running surface is on previously undisturbed (and presumably stable) soil horizons.

You can put the excavated material in an area needing fill material or in a disposal (waste) area. If the material does not pose a landslide threat, or if the amounts are small relative to the total excavated, you can sidecast the material along the edge of the road. However, if this practice is abused, landslides and sidecast failures can result, making large land areas unproductive.

A common practice on gentle slopes is to build part of the roadway on a stable bench and to use the excavated material to build a portion of the running surface (Figure 7). Remove all debris and woody material from the side slopes, and deposit the clean fill material here to minimize road failures from these slippage surfaces.

It is possible to calculate the amount of fill material needed and to excavate only

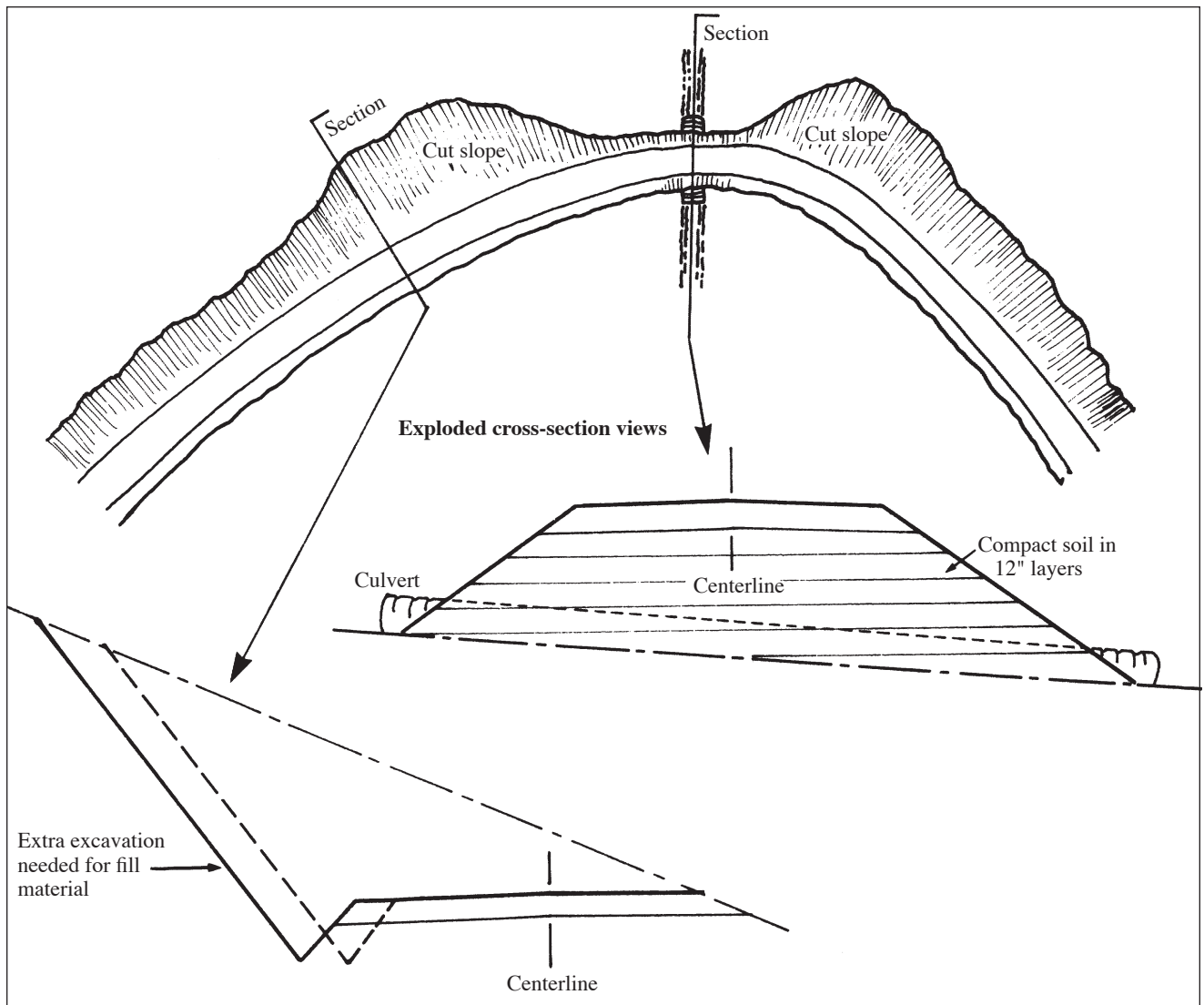

Figure 9.—Fill cross-section with extra excavation for fill material.

that amount for a road cross-section (Figure 8). Include an allowance for shrinkage to provide additional material in view of the fact that earth dug from a hole seldom will fill the same hole again.

When the amounts match, the cross-section is balanced. On gentle slopes, balanced sections minimize earthwork excavation and materials handling.

Balanced excavation also describes the length of a road where excavated materials

must be accumulated for a fill section (Figure 9). Road design procedures estimate the excess excavation needed on both sides of a fill section to provide material for the fill.

The extra excavation needed depends on the amount of shrinkage. Also, fill sections often are compacted in layers to develop road strength; thus, the amount of excavation depends also on the degree to which the fill will be compacted.

Information for Road Construction: Design Specifications

Contractors and landowners who build their own roads need specifications. Depending on the size of the job, specifications can be a simple list or they can be pages of contract provisions. Only the common specifications are discussed here, along with criteria for deciding which specifications are needed for woodland properties.

Road width

Most landowners want roads as narrow as possible to minimize costs and the land area removed from production. A 12-foot running surface usually is needed for log truck traffic. If you plan to gravel the road, the subgrade (width of the roadway including ditch) should be at least 14 feet. You may need to widen the road surface in segments or along the entire length.

If large logging equipment must move over the road, a minimum running surface of a solid 14 feet is needed (16-foot subgrade). Also, if you plan to use the road as a landing area, you may need wider sections to allow traffic to pass. Mark landings in advance and widen them during road construction. Even though traffic on woodland properties is controlled, plan turnouts so that traffic can pass.

Alignment

Alignment is the degree of curvature in the road. Roads should be as straight as possible; however, there are always tradeoffs in alignment questions. If road construction is made easier by adjusting alignment to fit the terrain, the road should have curves. However, there are limits on how sharp the curves may be and still allow log truck traffic.

Measure curves by the radius of curvature. A minimum radius of 50 feet is needed for log trucks (Figure 10). Another way to measure curves is the middle-ordinate method; make these measurements in the middle of the roadway rather than from the center of the circle (Figure 30, page 23).

Curve combinations are shown in Figures 11 and 12. Two curves going in the same direction join in a *compound* curve. Two curves going in opposite directions join to make a *reverse* curve. You can calculate limits of curvature during design, but the test of these combinations is whether a log truck can pass the curves. (If you plan to harvest poles on the property, the curves will need to accommodate the added vehicle length.)

Curves in draws or around ridges or switchbacks (horseshoe turns) on the slope are especially critical. If the curves are sharp, you can improve these trouble spots by *curve widening*—providing extra road width at critical points along the curve to

allow poles or logging equipment to pass (Figure 13, page 10).

Road intersections are another element of alignment. Design intersections so loaded trucks can make the turn easily. Intersections with public highways must be approved by the State Highway Division district engineer. Factors considered include sight distance (clear field of vision for oncoming traffic) and intersection width.

Grades

The slope (grade) of roads is either *adverse* or *favorable*. Favorable grades are downhill slopes in the direction a loaded

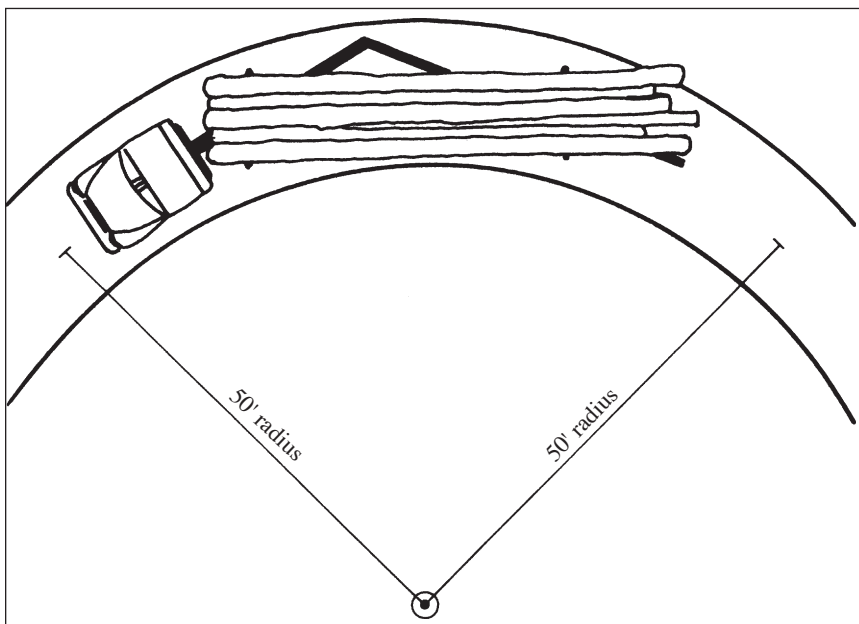

Figure 10.—Log truck on a curve with a 50-foot radius.

truck would travel; adverse grades are uphill slopes for loaded trucks.

Favorable grades may reach 12 to 15 percent for short distances. Adverse grades of less than 10 percent are recommended. Steeper adverse grades are possible under special circumstances, such as terrain conditions that require a short adverse stretch. Sharp curves require moderate grades, not greater than 7 percent.

If two grades join on the road, you need a vertical curve to smooth the transition (Figure 14, page 11). Failure to plan for these transitions can result in *truck bind*, caused by the limited vertical movement of loaded trucks. You can make calculations for vertical curves and build simple ones during road construction.

Intersections also are areas where grades are critical. In an area where one road leaves another, you must carry the original grade some distance to make a smooth transition. Thereafter, it's wise to separate the roads (causing grade differences) as soon as possible, especially on hillsides. If the traffic must stop or slow down at an intersection, make the favorable grade low so the vehicle can come to a stop, and also make the adverse grade low so the vehicle can start out again.

Landing grades must be just steep enough to drain off water. When loaded log trucks leave the landing, the grade must be low enough to get them started.

On all roads, surfacing makes a major difference for allowable grades. Rain on dirt roads quickly limits traction. If you plan a dirt road, you might make provisions to spread rock on certain stretches of the road for traction.

On gentle terrain, road grades may alternate from 2 to 3 percent favorable to 2 to 3 percent adverse without affecting truck efficiency. Rolling grades (alternate segments of favorable and adverse grades) can help drainage on all road surfaces because water velocity does not build up before it drains across the road. On inslope and outslope roads, rolling grades are essential for controlling surface runoff.

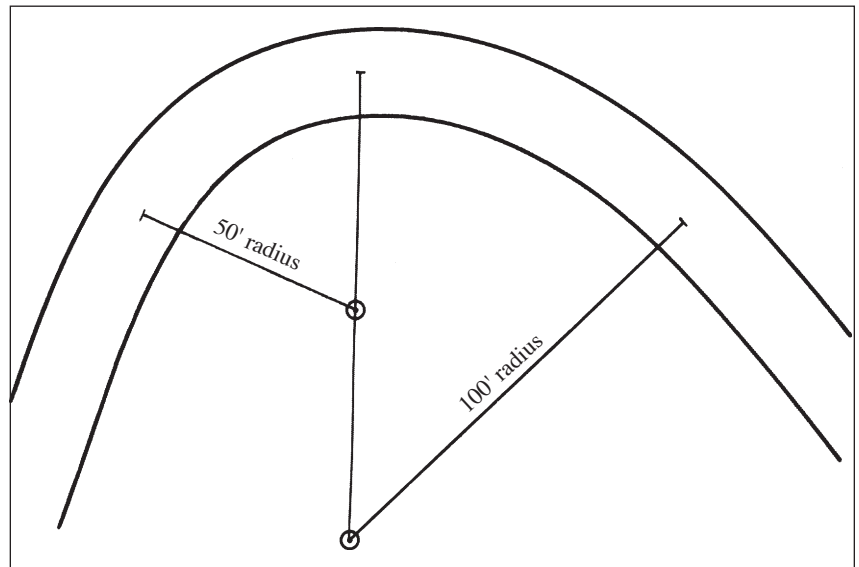

Figure 11.—Compound curve.

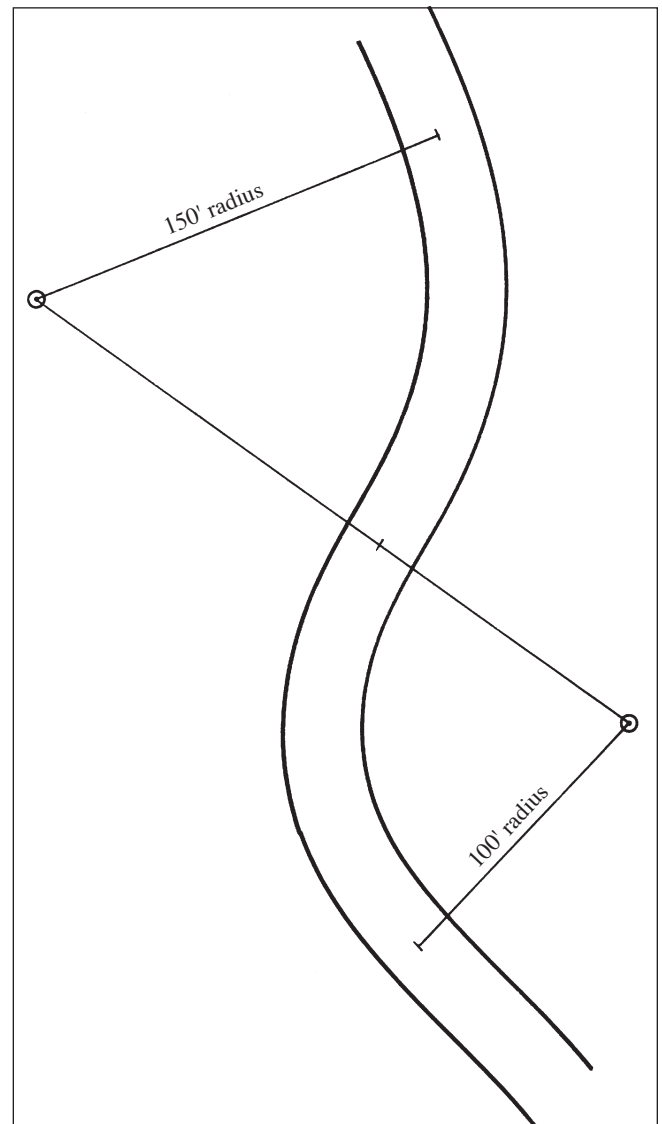

Figure 12.—Reverse curve.

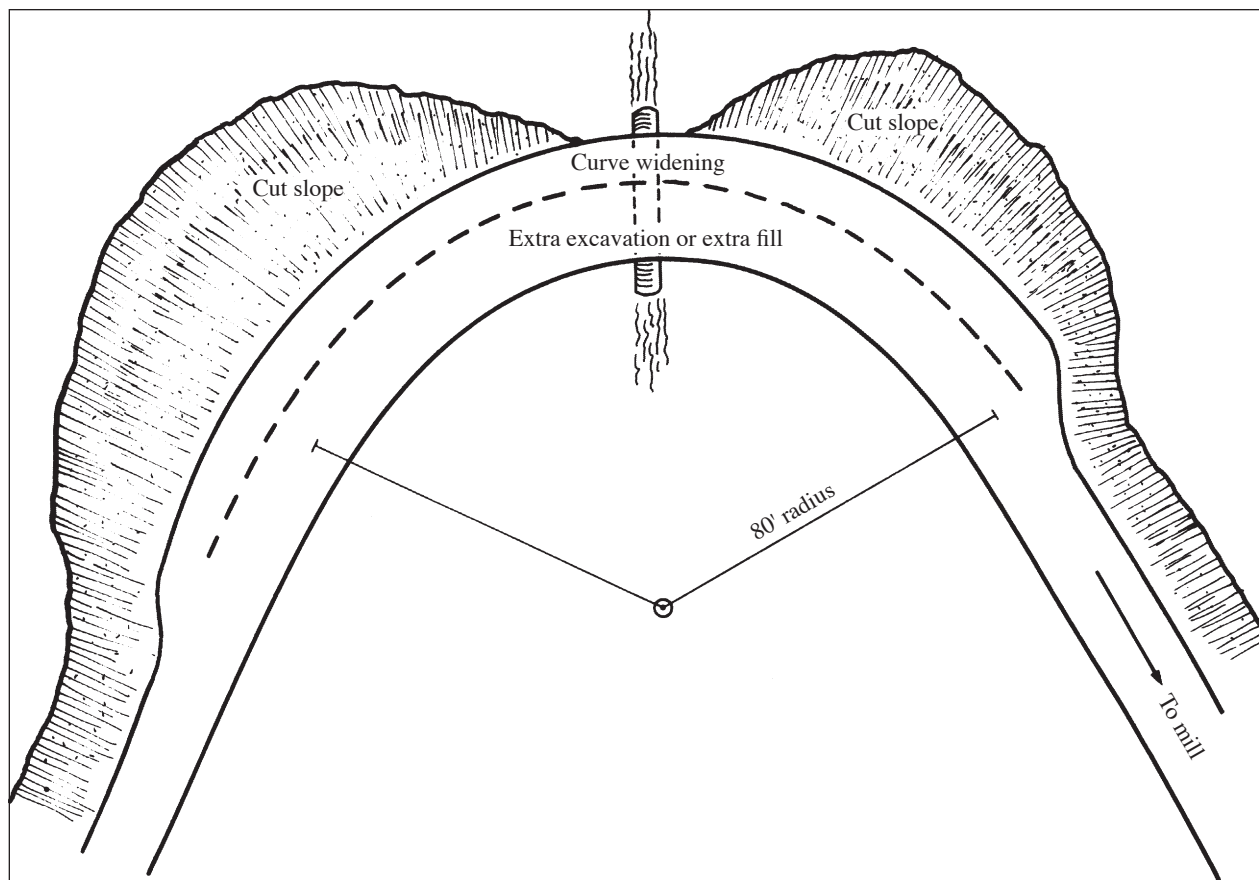

Figure 13.—Curve widening to permit truck passage on sharp curves.

Clearing limits

The clearing limits define the areas to be logged before road construction; you need to mark them for construction. These limits vary in width and extend about 5 feet beyond the edge of cut slopes or fills. A 30-foot clearing limit is considered a minimum width.

Remove vegetation from between the clearing limits and dispose of it outside the roadway or pile and burn it. Dig out stumps instead of leaving them to rot in the road.

Excavation

Because most forest road construction consists of excavation, road design specifies how much earth to remove at the centerline of the road and how steep to make the cut slope and fill slopes.

You measure cut slopes opposite the way you measure grades (Figure 15, page 12). For a $\frac{1}{2}$:1 cut slope, the elevation difference is one unit for every half-unit of horizontal distance.

Design cut slopes to match the soil type's ability to hold the slope's steepness. Steep hillside slopes of hardpan soils, high in clay, can hold a $\frac{3}{4}$:1 cut slope, but gentle slopes with loose, noncohesive soils need a 1:1 cut slope. (Rock can be cut vertically.)

An extra amount of soil is exposed to erosive forces when the cut slope is not steep enough for the soil to hold. In fact, on some steep slopes, a 1:1 cut slope may not be as steep as the adjacent ground slope (the slopes may not match; see Figure 16, page 13). On the other hand, the cut slope will fail if it is too steep for the soil to hold (Figure 17, page 13).

Fill slopes also depend on terrain steepness and soil types, but to a lesser degree than cut slopes. Fills usually are designed to have a $1\frac{1}{2}$:1 slope (Figure 18, page 14) because this is the steepness that loose or uncompacted earth will hold. The stability of fills on sloped terrain depends on the ground's steepness; fills on slopes that are more than 65 percent will not catch (attach

(continued on page 12)

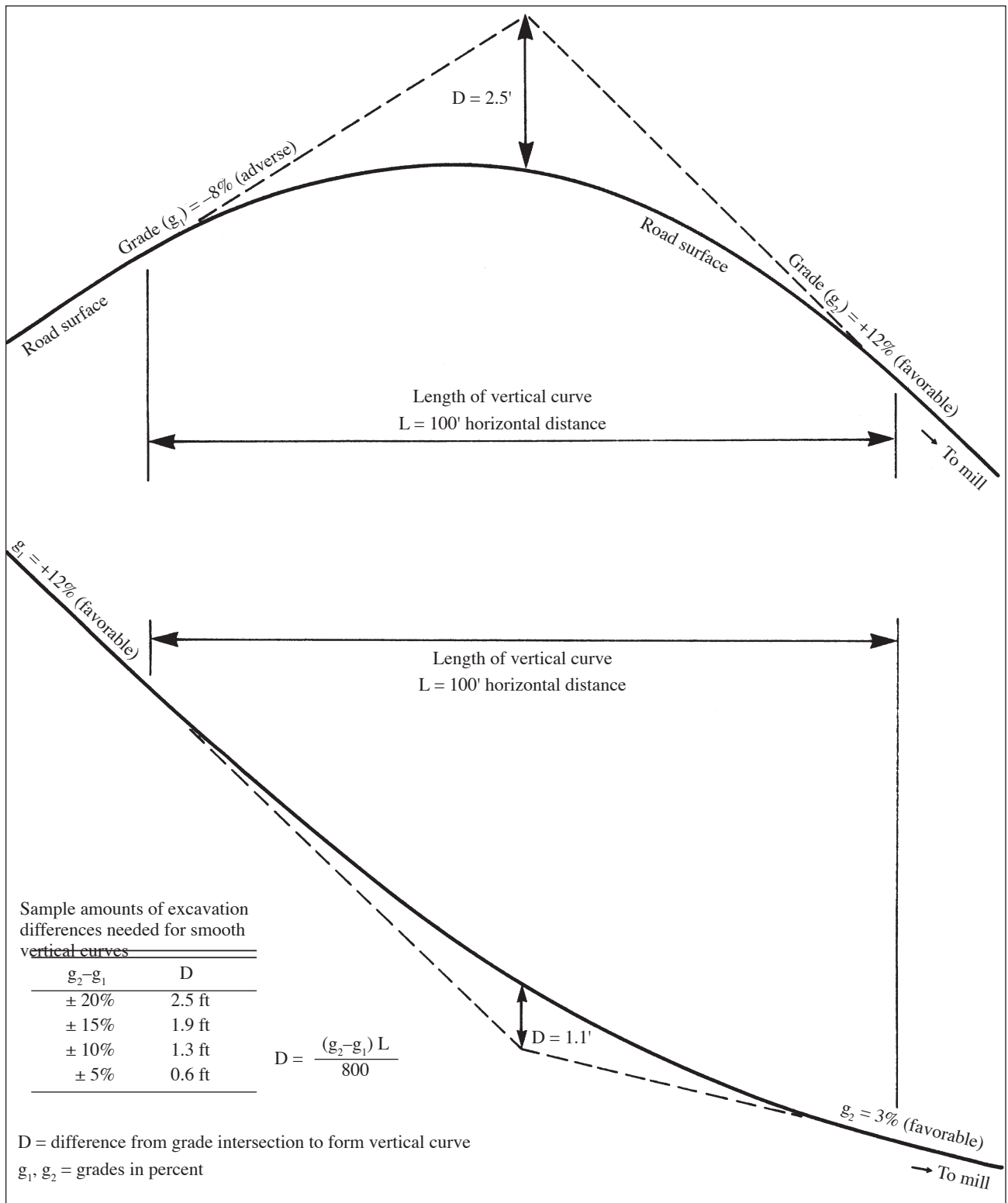

Figure 14.—Vertical curves.

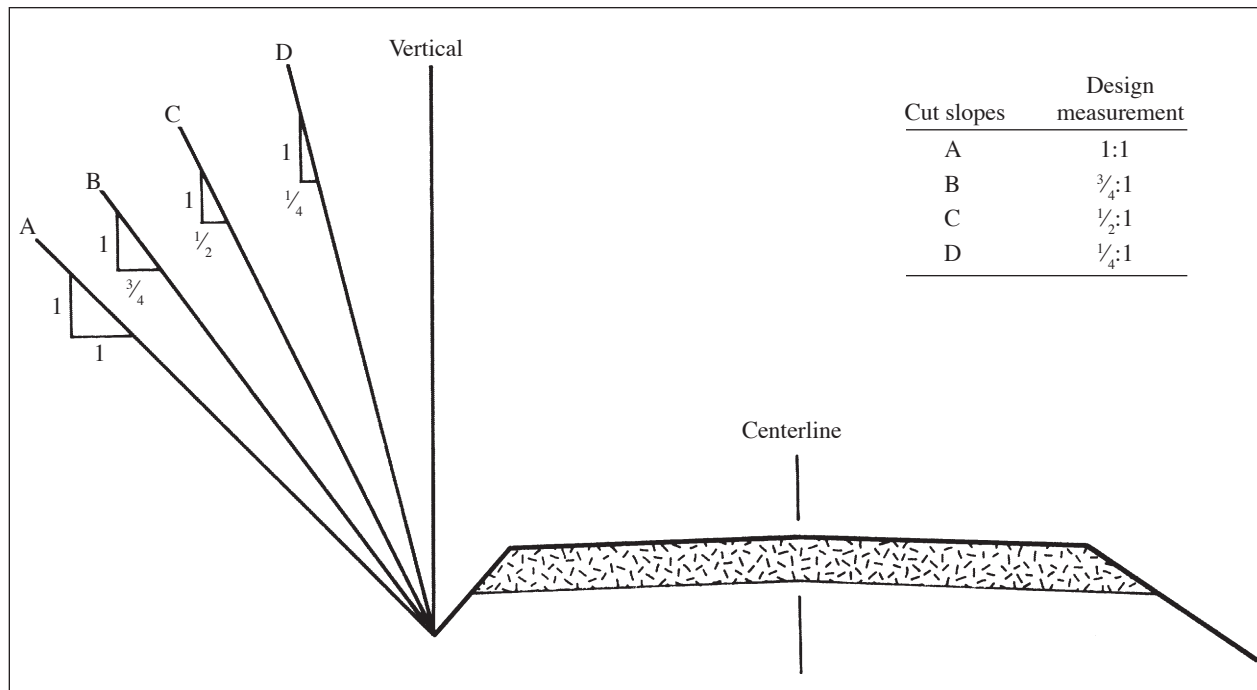

Figure 15.—Cut slopes at common steepnesses.

to original ground) nor provide support. Material will ravel (slide away) down the hillside (Figure 19, page 14).

Specify where to dump excess excavation in your road design. Waste areas need to be flat and stable. Occasionally, material needed for a fill is unavailable or of poor quality nearby. To make up for this, you can include borrow pits (excavations outside the construction area providing soil and/or aggregate) in your road design.

End-hauling is the process of removing material from its excavation site or transporting it to a fill area with a dump truck. While the machines typically used to build a road can move material 300 to 400 feet, it's usually more economical (although still costly) to load the material in dump trucks for hauling. Good road design eliminates or minimizes end-hauling.

Occasionally, you can anticipate road surface problems and specify the solutions in road design. Wet spots are likely to cause problems. Your design may call for cull logs to be placed side by side over these areas (corduroy). You also may use special fabrics or dig out the wet material and replace it with rock or better material (replace blue clays with sandy soils).

Compaction benefits road subgrades, especially fills. Specifications for compac-

tion can be simple or complex, depending on how much the soil strength must be improved.

For woodland roads, it's common to specify that fills be built up in 12-inch lifts (layers) and compacted each time by the roadbuilding machine. You may need compaction machines if the fill is large or if soil strength is very low. Consider compacting the entire subgrade if you must surface the road immediately after construction.

Road structures

You need specifications for all structures that you build into forest roads. This includes bridges and complicated support structures as well as the often overlooked culverts and the earth-constructed items such as water bars and dips. Bridge specifications are taken for granted, but you must construct earthwork structures and culverts by design as well.

Stream crossings

Use culverts made from steel, aluminum, concrete, or polypropylene to cross small streams. Their size depends on local conditions (rainfall, area drained, etc.), but an

(continued on page 16)

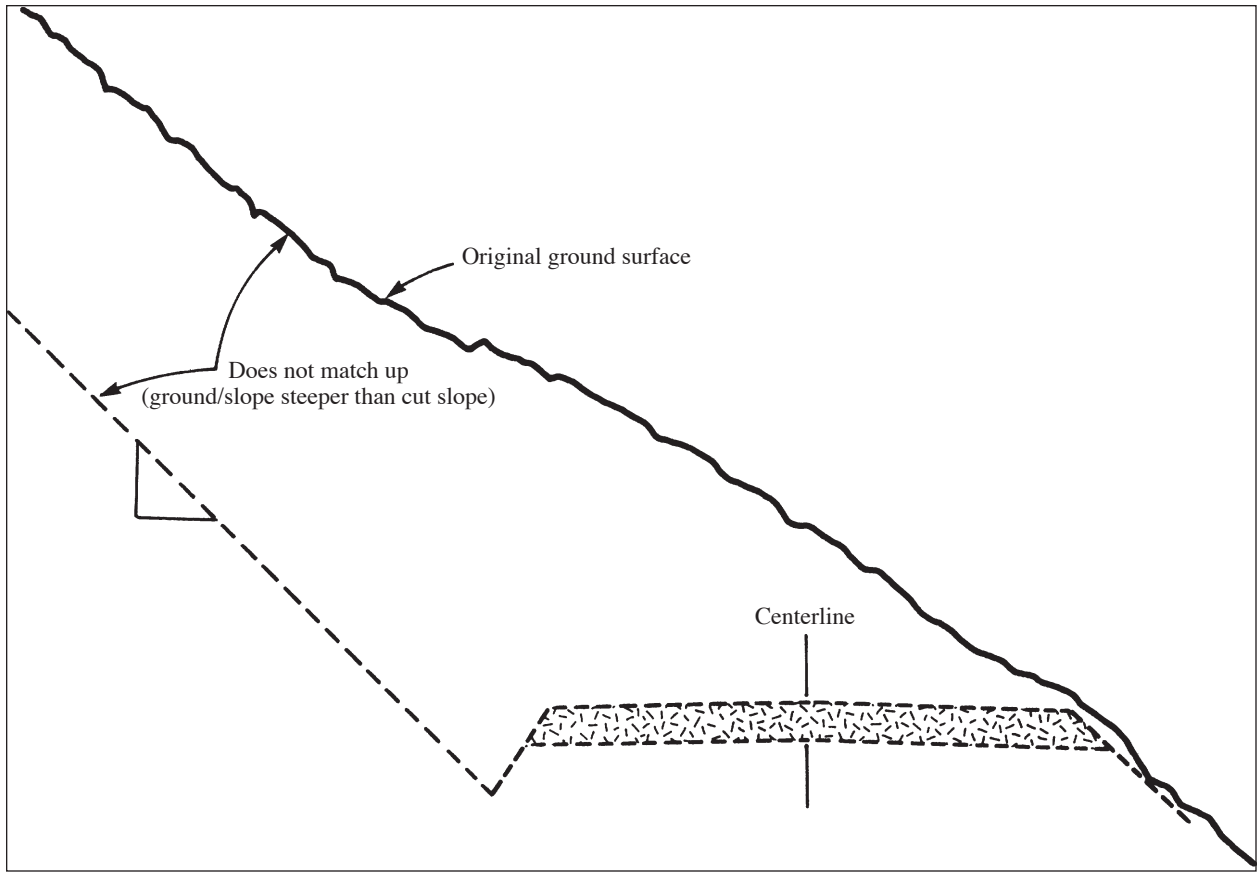

Figure 16.—A 1:1 cut slope never matches a steeper ground slope.

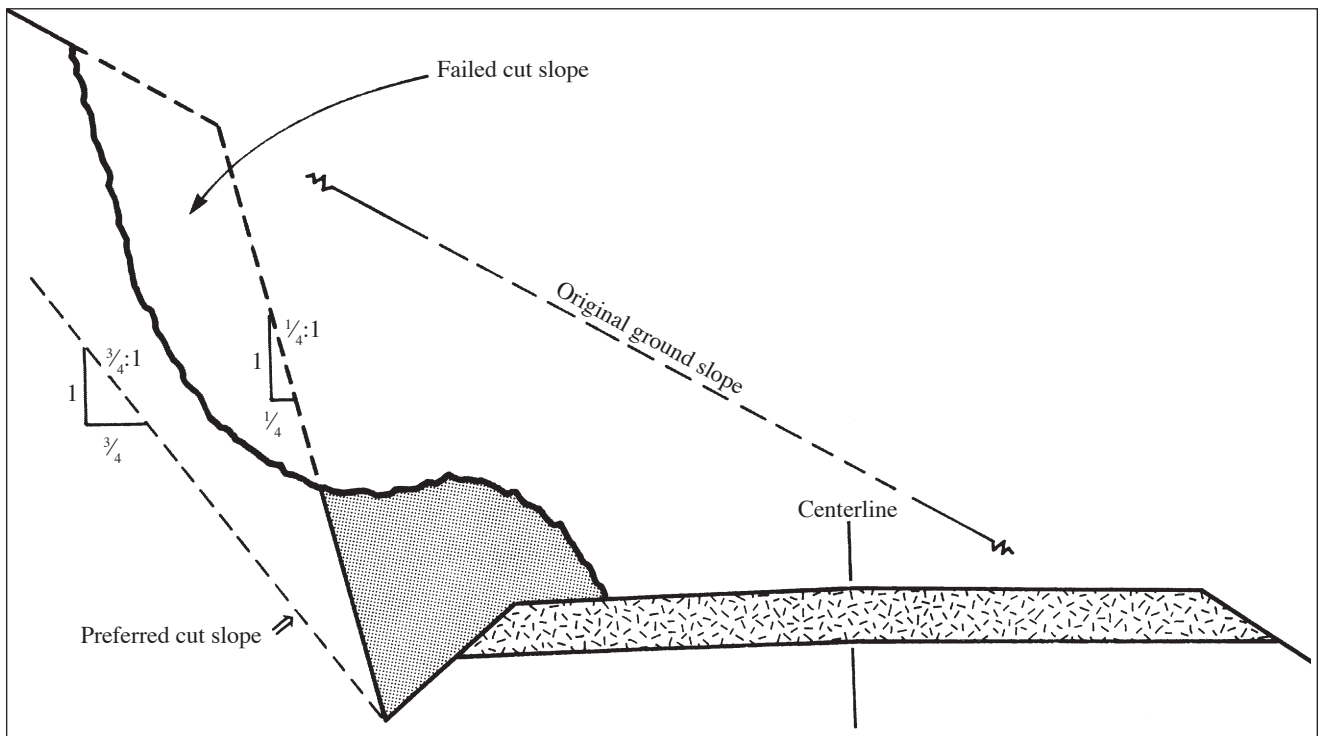

Figure 17.—Cut slopes that are too steep may fail.

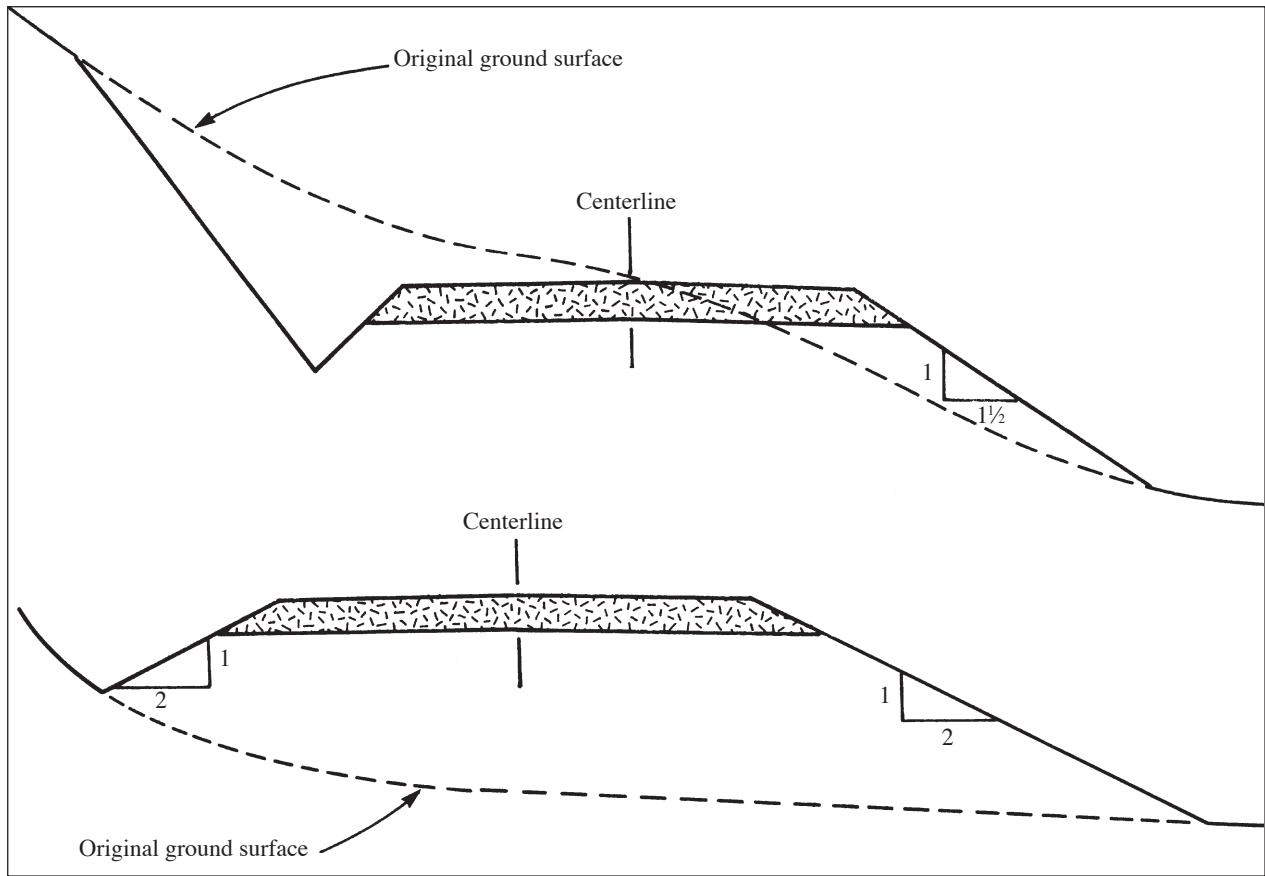

Figure 18.—Partial fills at (top) 1½:1 and (bottom) 2:1 fill slopes.

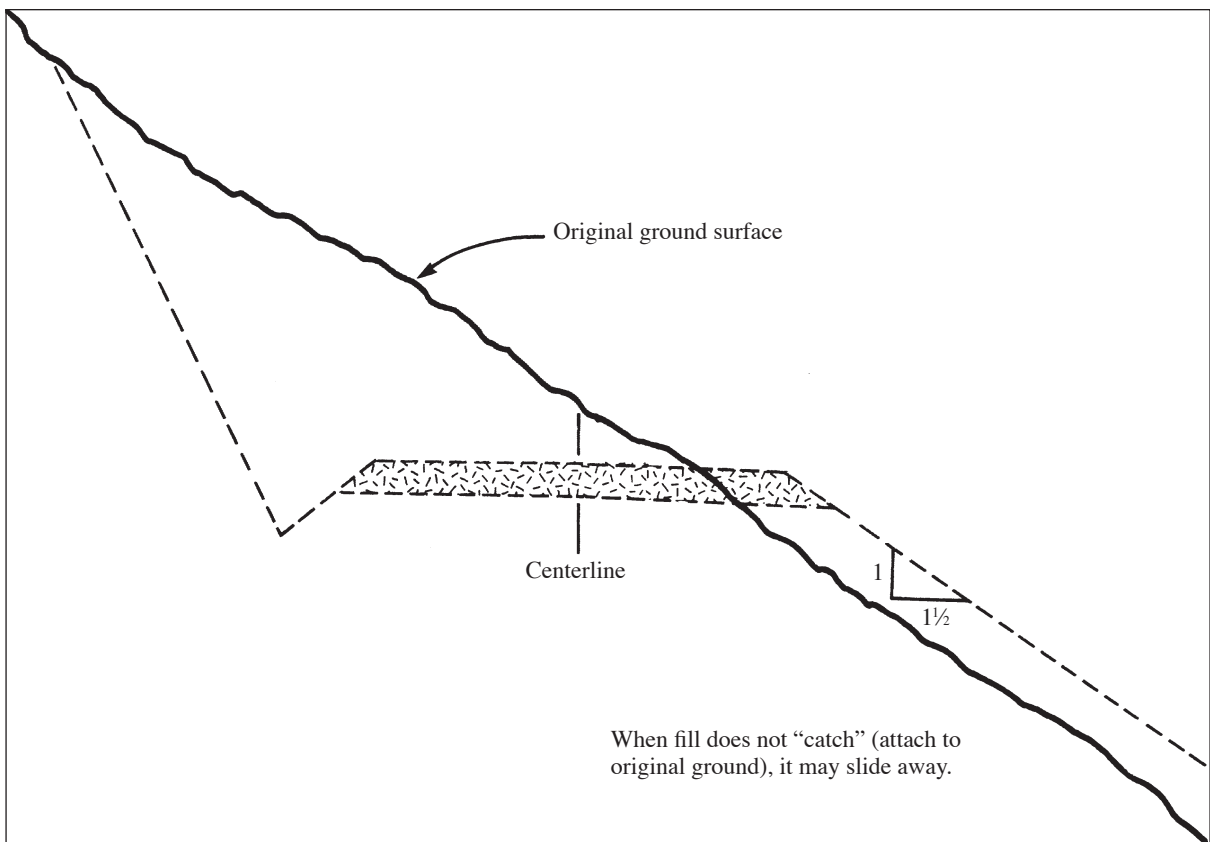

Figure 19.—Fill slopes will not catch on steep slopes.

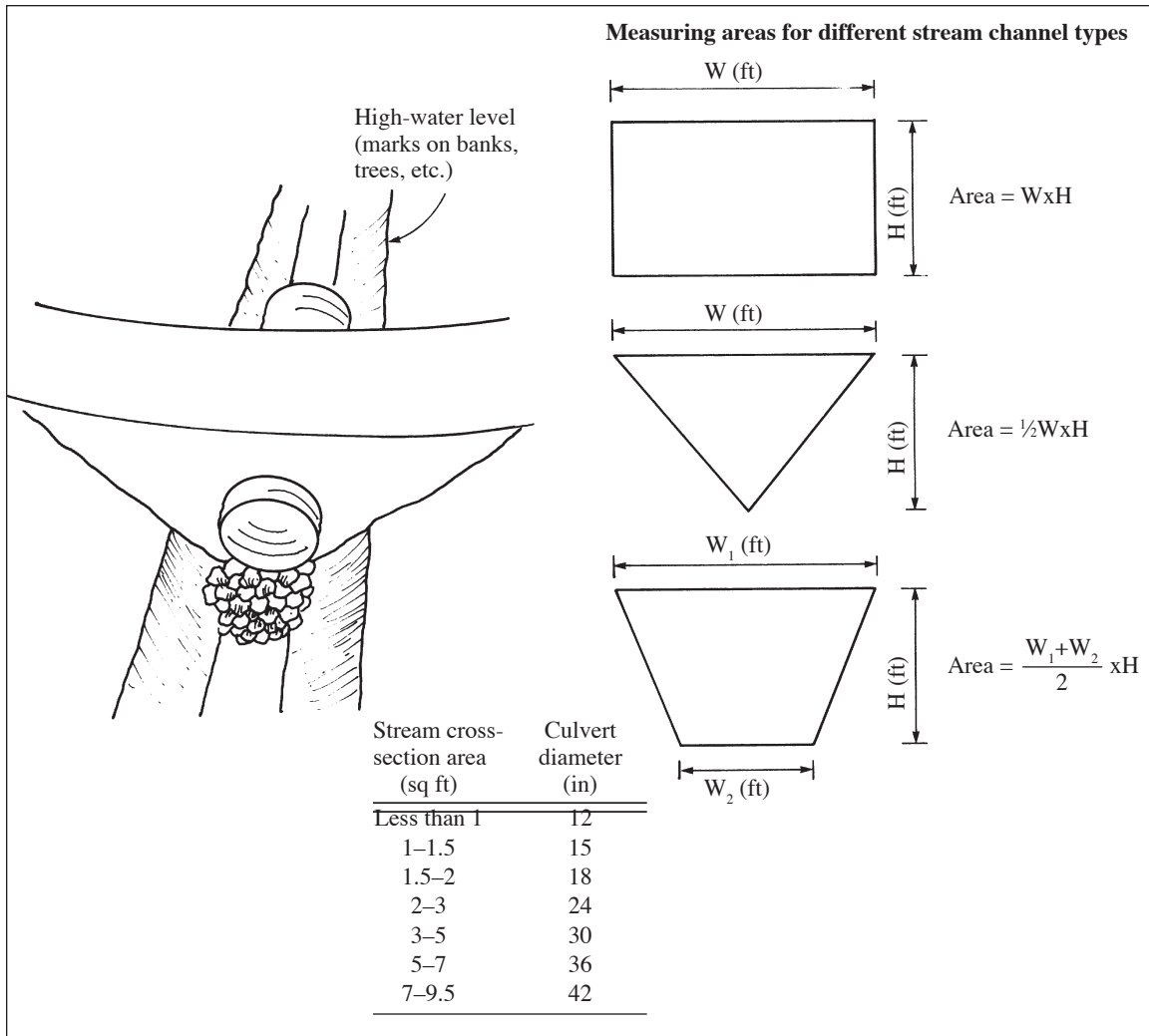

Figure 20.—Estimating channel areas for culvert sizing.

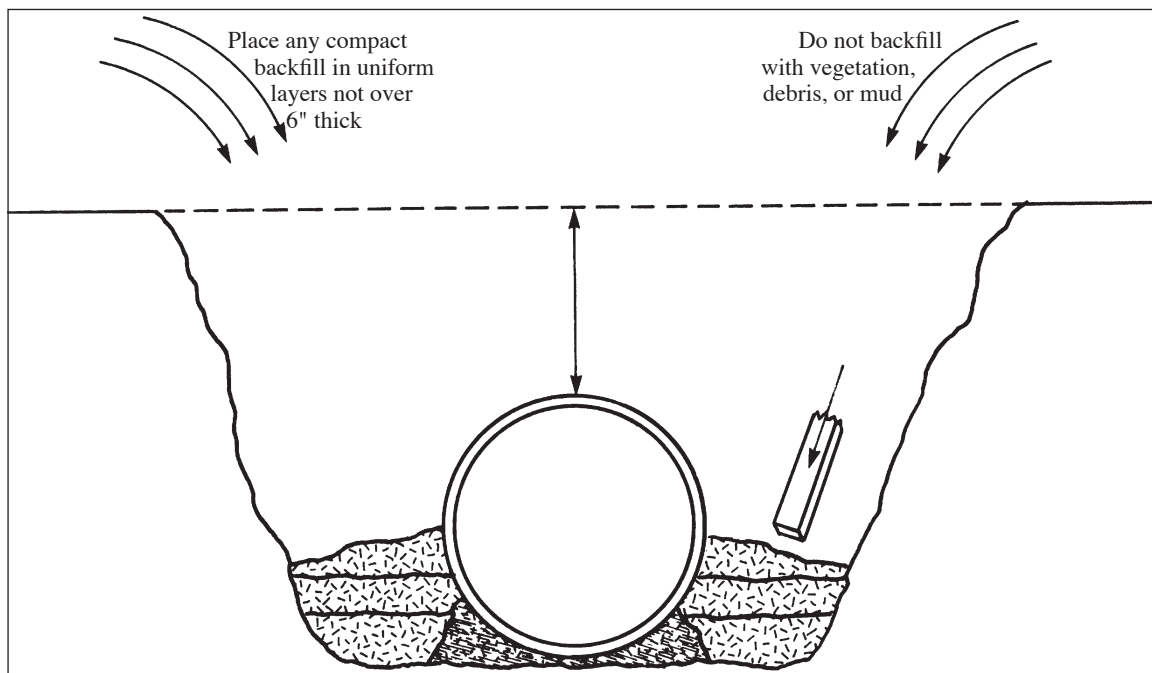

Figure 21.—Culvert installation.

acceptable starting point is to have the area of the culvert opening equal the area of the stream channel at the historical high-water level.

Figure 20 (page 15) shows how to measure channel area and lists the associated culvert sizes. Streams that require culverts wider than 30 inches require professional evaluation.

Installing culverts is more than just placing a pipe in a stream. The compacted earthwork around a culvert provides considerable support to the culvert (Figure 21, page 15). Also, you must consider the areas upstream and downstream from the culvert.

Clear the upstream area of woody debris that can plug the culvert. The culvert grade on the downstream end should be close to the natural stream grade. If this is not possible, armor the outfall area with large rocks to reduce erosion.

In fish-bearing streams, culvert design must take into account how fish will get into and out of the culvert as well as the maximum water velocity in the culvert. Professional advice is available from the Oregon Department of Forestry.

Under some circumstances, you might use pipe arches, bridges, fords, or temporary crossings instead of culverts. Proper design may eliminate use of poor crossings, such as three smaller pipes to form a culvert when a single culvert is more effective (Figure 22). Less costly approaches may save money in the short run, but their effectiveness sometimes is so limited that they are not economical, especially if they fail in service.

Cross-drains

Several structures are available for draining water across the road. These range from simple earthwork structures, such as water bars and rolling dips, to open-top, wooden culverts and pipe culverts of various materials. Figures 23, 24, 25, and 26 (pages 17 and 18) illustrate these options. (Woodland owners usually are most interested in the low-cost, effective options.)

Proper design of cross-drain structures considers where the water will drain across the road. Use outfall protection measures such as rock riprap (rocks used as armor), culvert half-rounds, and water discharged

on stable locations to prevent erosion and road undermining.

Slope stabilization structures

Under special circumstances, woodland roads may need to cross unstable slopes. You can use structures such as bin walls, sheet piling, rock buttresses, and half-bridges, but they do require professional assistance. Although these structures may cost as much as a bridge, you should be aware that they exist to solve particular slope stability problems.

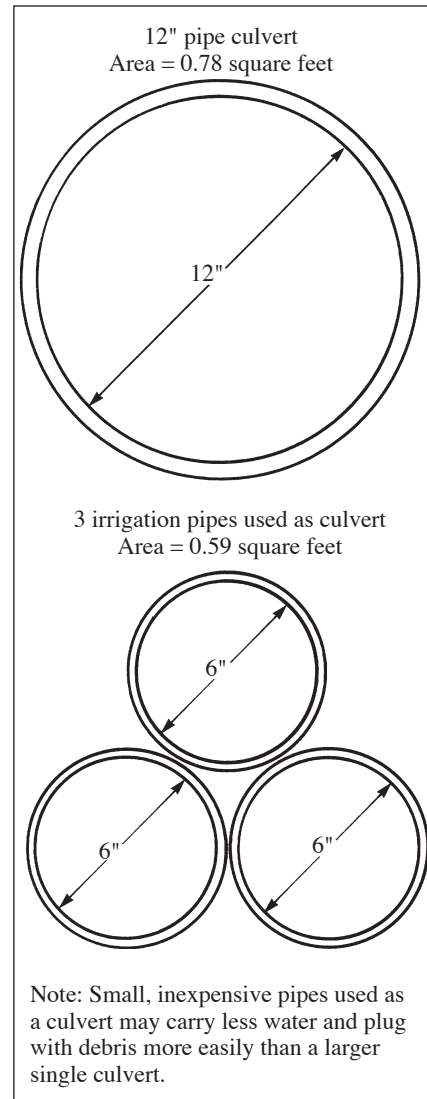

Figure 22.—A comparison of three pipes to a single culvert.

Proper design aids maintenance

If you design and construct a road properly, maintaining it is much easier. The key requirement is to plan for *drainage! drainage! drainage!* You need to design frequent cross-drains and stream crossings to control water during storms (Table 1). Roads that control water solve most maintenance problems that are likely to occur.

Field Location and Layout

Ribbons, wooden stakes, and metal tags direct the construction process on the planned roadway.

There is no single standard or marking system to provide construction control, but the information provided is common to all road construction.

This information must be in a form that the machine operator can understand; if the operator doesn't understand the information, the contractor (or woodland owner) must explain the markings. Furthermore, the owner or contractor may need to replace construction stakes and other markers because the construction process may obliterate them. A careful preoperation review is essential, and construction supervision must be frequent enough to avoid problems.

Information that machine operators need

Figure 27 (page 20) provides a typical road cross-section with types of information shown on ribbons, tags, and stakes. Establish the right-of-way or clearing limits with ribbons or colored paper tags.

Stake the centerline of the road; this is especially critical on curves, switchbacks, and intersections. The stake shows the amount of cut or fill at centerline as well as the station of the stake (stations are given as 12+50, meaning the stake is 1,250 feet from the beginning of the road).

Table 1.—Water bar spacing guide.^a

Road grade (%)	Soil type		
	Granitic or sandy (ft)	Shale or gravel (ft)	Clay (ft)
2	900	1,000	1,000
4	600	1,000	800
6	500	1,000	600
8	400	900	500
10	300	800	400
12	200	700	400
15	150	500	300
20	150	300	200
25+	100	200	150

^aDistances are approximate only; vary them to take advantage of natural features. From: *Forest Practice Notes*, No. 1, "Water Bars," June 1979. Salem: Oregon Department of Forestry.

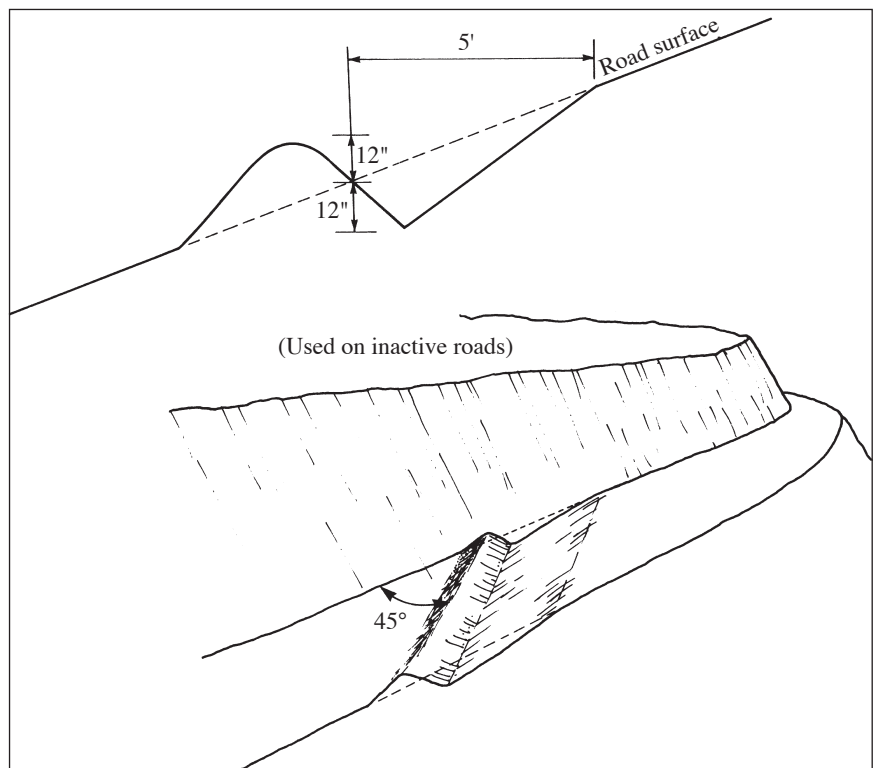

Figure 23.—Water bar cross-section and placement (used on inactive roads).

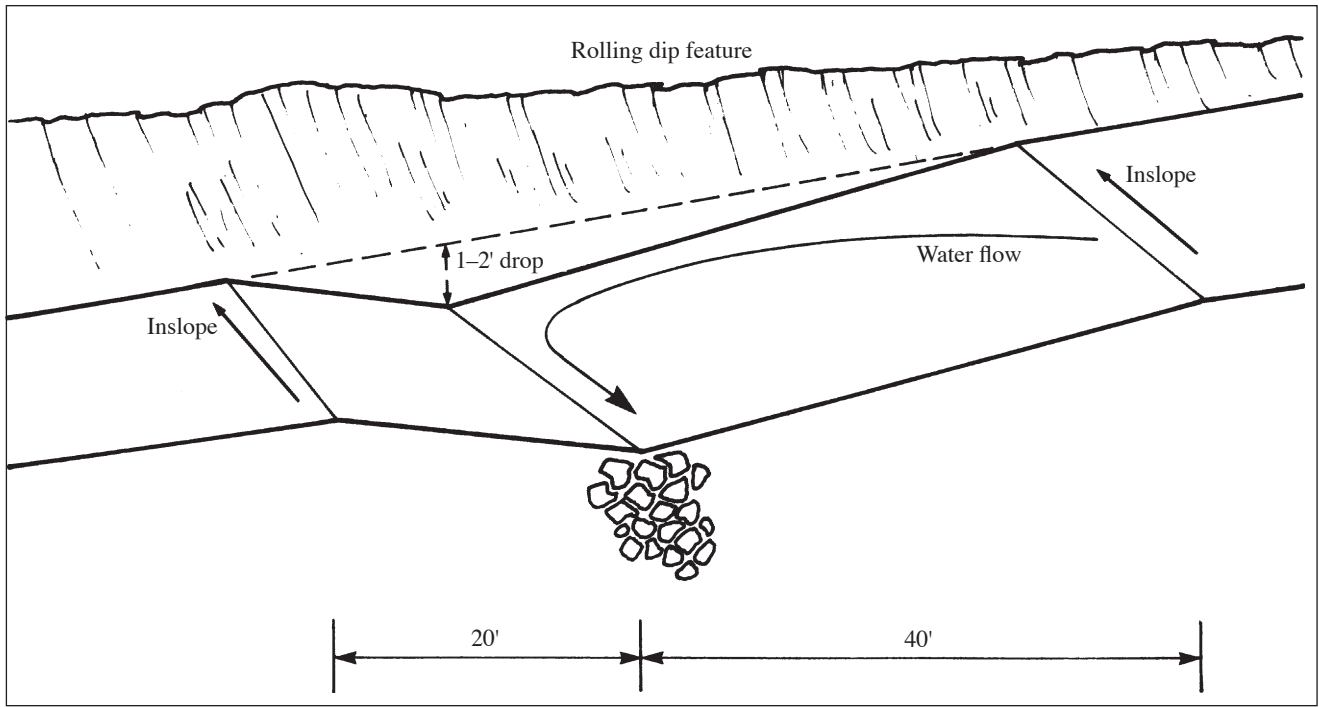

Figure 24.—Use a rolling dip to drain surface runoff.

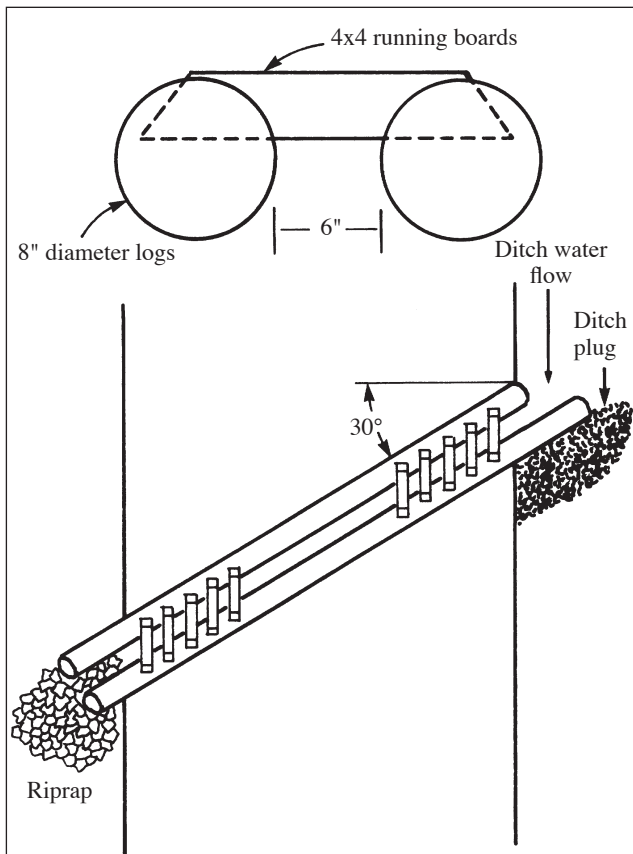

Figure 25.—Wooden open-top culvert.

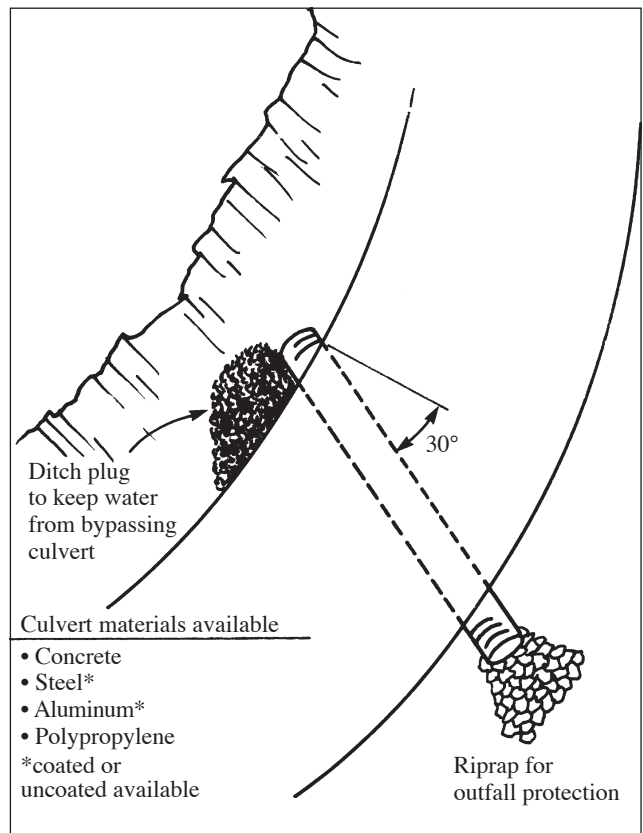

Figure 26.—Pipe culvert installation.

The operator needs to know where to begin cutting and the slope of the back cut. This information is given on a *slope stake*, a stake marking the point where the outer limit of a cut or fill meets the original ground (Figure 27, page 20). When the operator has this information, cutting or filling can begin at the slope stake, and the proper road width will be achieved at the same time the road reaches the planned grade elevation.

In addition, reference tags commonly are placed on trees facing the road. Tags give all information needed to reestablish the centerline, the road station, the intended back slope, the position of the slope stake, and the elevation of the final road grade. Be sure to place reference tags where they will not be obliterated during road construction.

The machine operator also needs to know how to use the excavated material. A road profile showing ground levels and proposed grades is very useful, if available (Figure 28, page 21). The profile shows where cut and fill sections are located along the road.

Profiles also give information on stream crossings, culverts, road cross-drains, and other vital matters. If a profile is not available from engineering information, a sketch—though less accurate—still will be valuable.

The construction crew can avoid future problems with culverts and cross-drains by installing them properly in the first place. Figures 21, 23, 24, 25, and 26 are some examples that you can include in specifications or use to communicate with the construction crew. Don't assume crews know all the details of installation; at a minimum, the installation instructions serve as reminders and express your concern.

Curve layout on woodland roads

When it's time to locate curves in the field, you may be perplexed about how to begin. Two simple approaches are discussed here, and while they may be adequate for many circumstances, you may require more involved techniques for complex situations.

Curves often connect two straight pieces, or tangents, of road. On gentle terrain you can roughly stake these tangents ahead of time. The line bisecting the angle between

the tangents is the line along which the curve will be centered (Figure 29, page 22). If you can pick the place where you want the road to cross this bisecting line, you can locate the center of the curve by trial and error. The correct radius curve will just touch the centerline of each tangent and also will hit the area you want the road to cross.

Try this on paper with a compass (or cut out some circles of various radii to fit between the tangents) for practice. Once you locate the center of the curve in the field, you can use two tapes or measured ropes to find the stations along the curve.

On more difficult terrain, such as sharp draws, ridges, and hillside switchbacks, it may be impossible to locate the center of the curve. In these cases, use the middle ordinate (stick-length) layout system.

This system may be even easier to use than locating the center of the curve. Figure 30 (page 23) gives a procedural approach; however, you should be aware that several trials may be necessary to get the curve to fit. Once you come close to getting the curve to fit, the construction process can make it smoother as the road is built.

This publication illustrates both of these systems for simple curves, but they work equally well for compound and reverse curves. However, the presence of complex curves may indicate that you need professional assistance.

During road construction, it's useful to restake the difficult curves after completing the right-of-way logging. The machine operator then will be able to construct curves effectively.

Checking road construction

Road design is ineffective if it's not reflected in construction practices. It is necessary to check on road construction frequently to determine whether the road is at the planned grade and whether the centerline is in the correct position.

Figure 31 (page 25) shows a road under construction that is not yet ready to grade. Using the information on the reference tag, you can check on the road construction progress.

Two approaches are possible: use a hand level to check the amount of cutting (or

(continued on page 22)

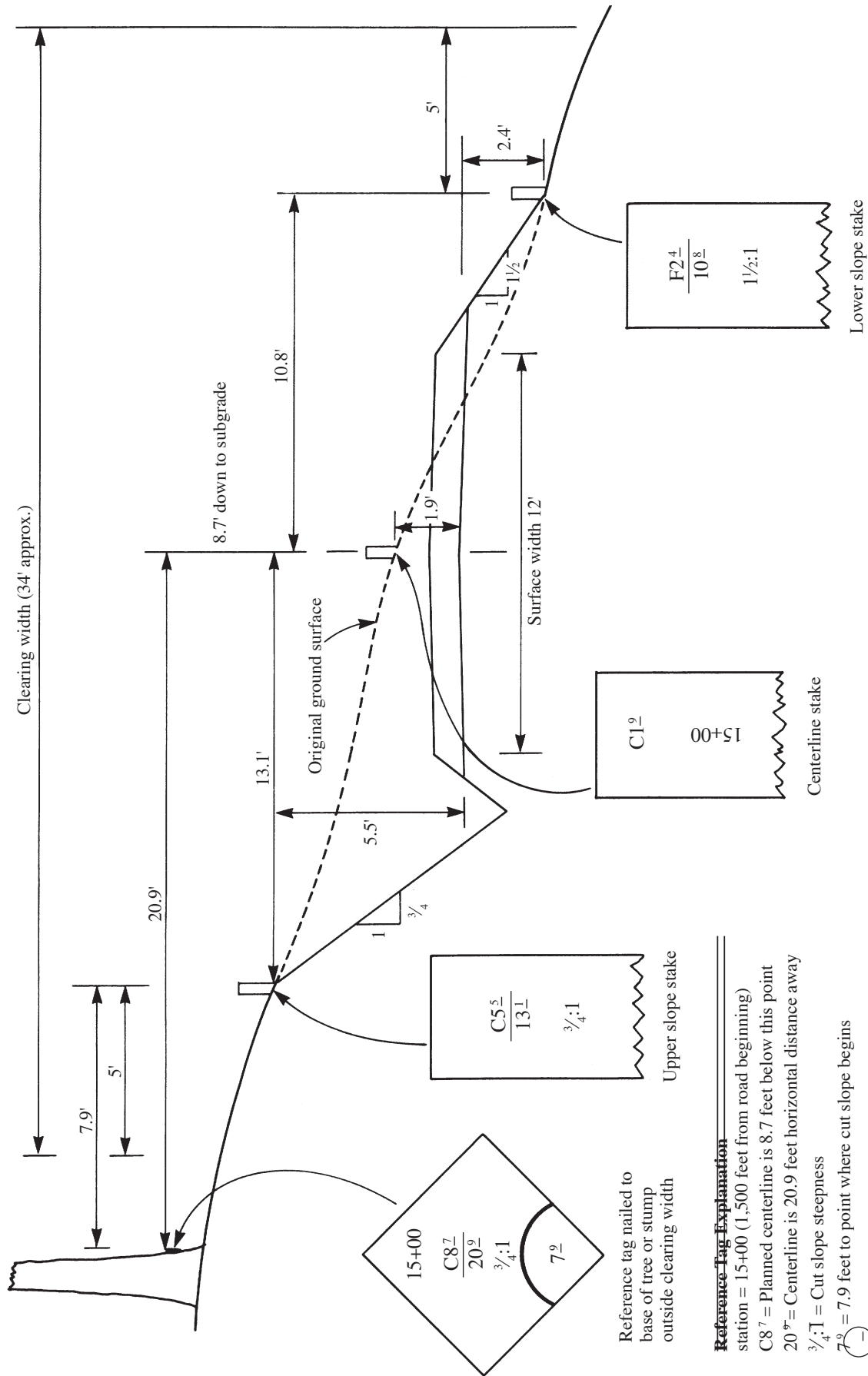

Figure 27.—Road cross-section showing construction information.

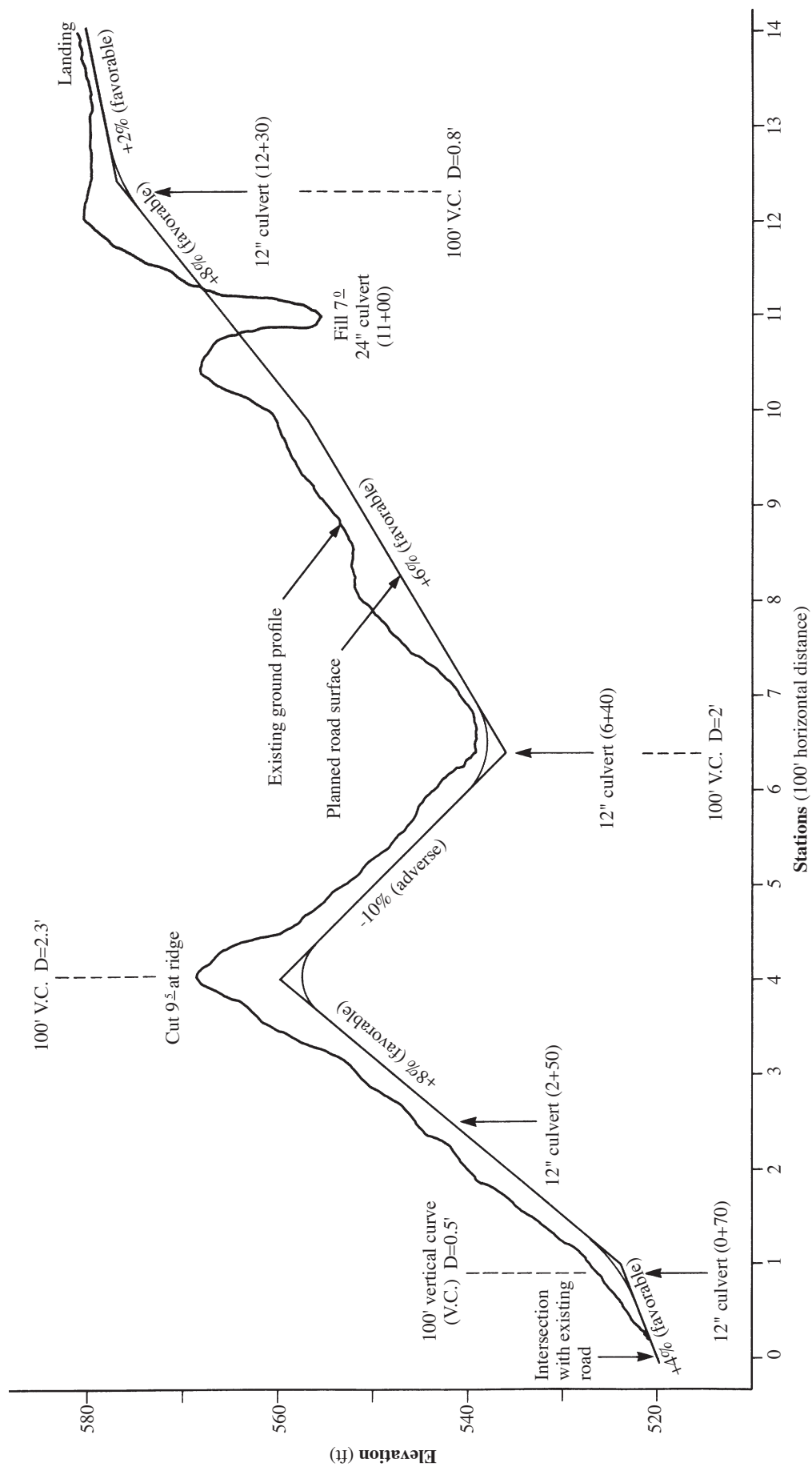

Figure 28.—Road profile for construction.

filling) thus far, or use an abney or a clinometer (devices for measuring slopes) and convert the percentage reading, along with the slope distance, to vertical and horizontal measurements. Carder's slope reduction tables are available to help convert slope readings and slope distances to vertical and horizontal distances (Table 2, page 26.) You then can reestablish the centerline and leave a stake to tell the operator how much more cutting (or filling) is needed.

Abneys and clinometers also give direct readings on road grades between two points on the road (Figure 32, page 25). Critical places to check are curves (especially vertical ones), switchbacks, intersections, and steep segments.

Checking road construction does not mean rigid adherence to field location guidelines. The road construction process is not exact. Grades within ± 1 percent and excavation to the nearest foot usually are acceptable. The criterion should be whether the road will serve the intended function.

Good construction often improves on road design. However, failing to construct some portions of the road to design specifications and ignoring the field layout and location markers can lead to roads that are problems for trucking and maintenance activities.

(continued on page 24)

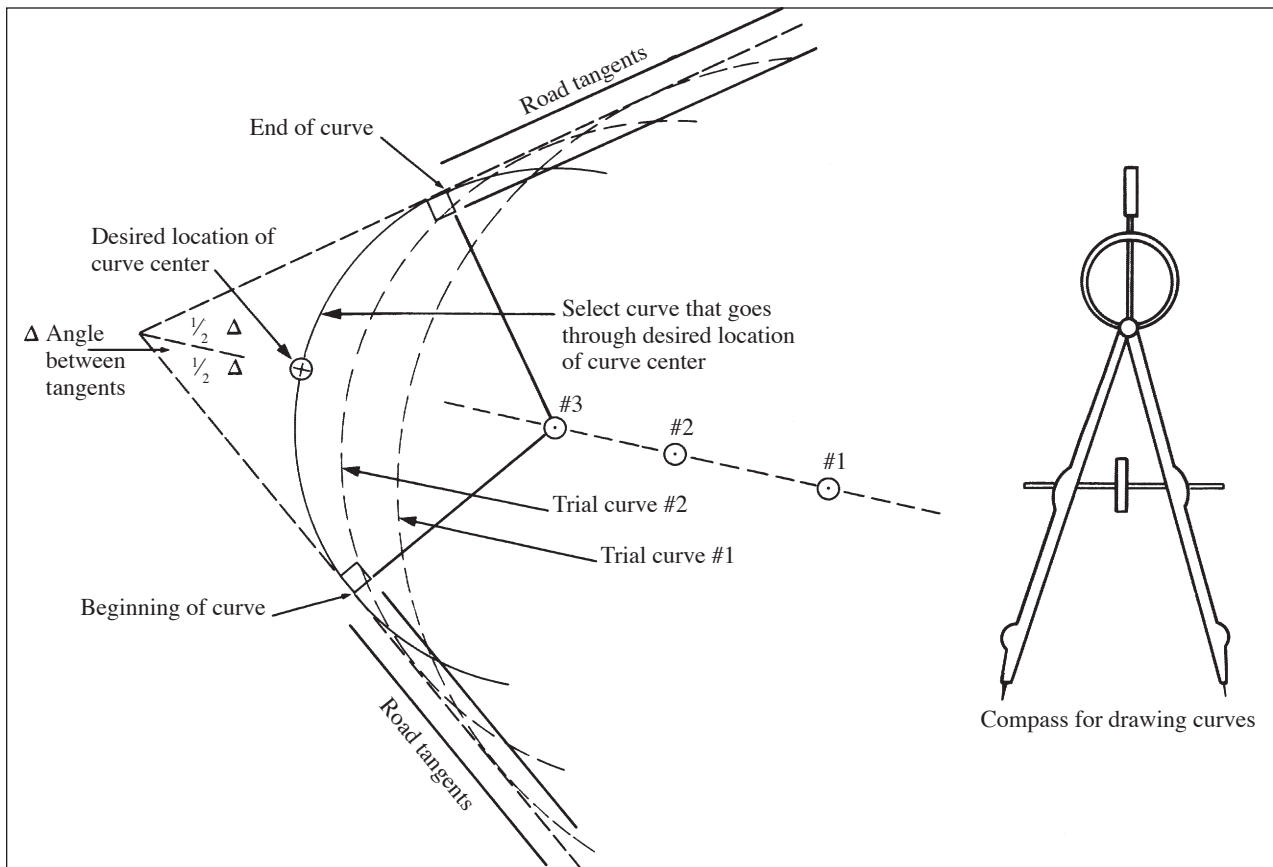

Figure 29.—Trial curves with the center of the curve located.

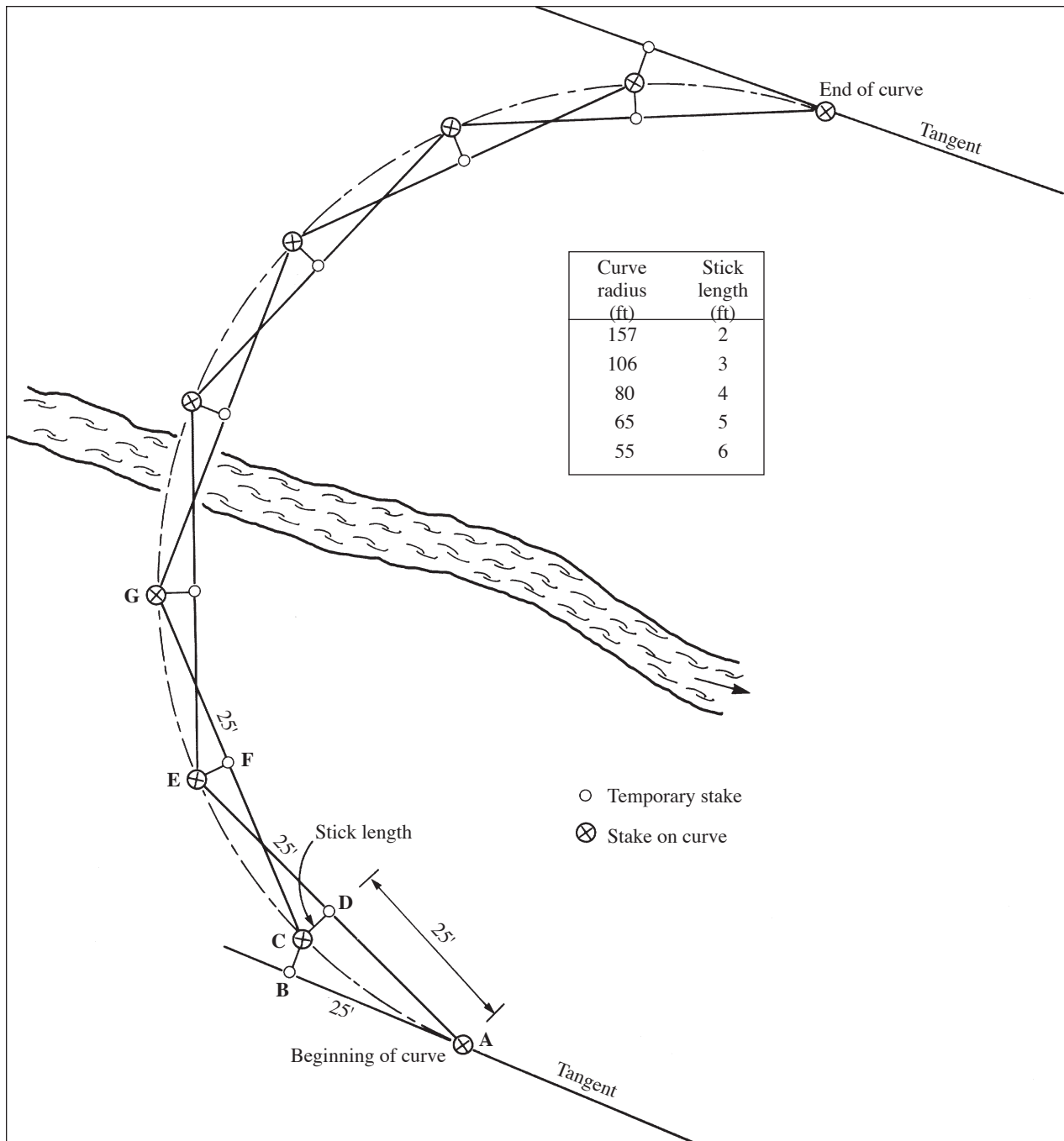

Figure 30.—The middle-ordinate curve-location method.

Follow the steps below to lay out a curve using the middle-ordinate (stick-length) method. Assign letters to the stakes you use for layout. Once a curve fits a given location, mark the stations on the stakes starting from the beginning of the curve (for example, if stake A = station 12+10, and stakes are used every 25 feet, then stake C would be marked 12+35; stake E, 12+60; and so forth). All distances are horizontal measurements (they are not on the slope).

1. Select the desired radius curve and the corresponding stick length to use.
2. From stake A, measure 25 feet to B, extending the tangent line at the beginning of the curve. At right angles to the tangent, set stake C one stick length from the tangent. You now have the first stake on the curve.
3. At C, measure off the stick length toward the center of the curve and set temporary stake D. From A, sight through D and measure off 25 feet from D to set stake E (another stake on the

- curve).
4. At E, measure a stick length toward the center of the curve and set temporary stake F. From C, sight through F and measure off 25 feet from F to set stake G on the curve.
5. Repeat these steps until you approach the tangent for the end of the curve.
6. If the curve does not fit on the first trial, you have several options to fit the curve.
 - Change the stick length (and thus the curve radius). A longer stick makes a sharper curve; a shorter stick makes a curve of larger radius.
 - Start the curve earlier than stake A or later (at B) to fit the topography.
 - Try combinations of various starting points and stick lengths.

Summary

Road specifications and field layout and location are the essence of road design. Professional service is available for significant woodland roadbuilding projects, but you, the landowner, may wish to design simple and small-scale road projects. The information provided here will help you do your own road design or supervise those providing contract road design. Additional sources are listed below.

For Further Reading

Adams, Paul W. *Soil Compaction on Woodland Properties*, EC 1109. .

Adams, Paul W. *Maintaining Woodland Roads*, EC 1139.

Garland, John J. *Planning Woodland Roads*, EC 1118.

Garland, John J. *Designated Skid Trails Minimize Soil Compaction*, EC 1109.

Garland, John J. *Road Construction on Woodland Properties*, EC 1135.

To order copies of the above publications, or additional copies of this publication, visit our online catalog at <http://extension.oregonstate.edu/catalog/> Or, send the complete title and series number, along with a check or money order, to:

Publication Orders
Extension & Station Communications
Oregon State University
422 Kerr Administration
Corvallis, OR 97331-2119
Fax: 541-737-0817

We offer a 25-percent discount on orders of 100 or more copies of a single title.

World Wide Web

You can access our Publications and Videos catalog and many of our publications through our website at <http://extension.oregonstate.edu/catalog/>

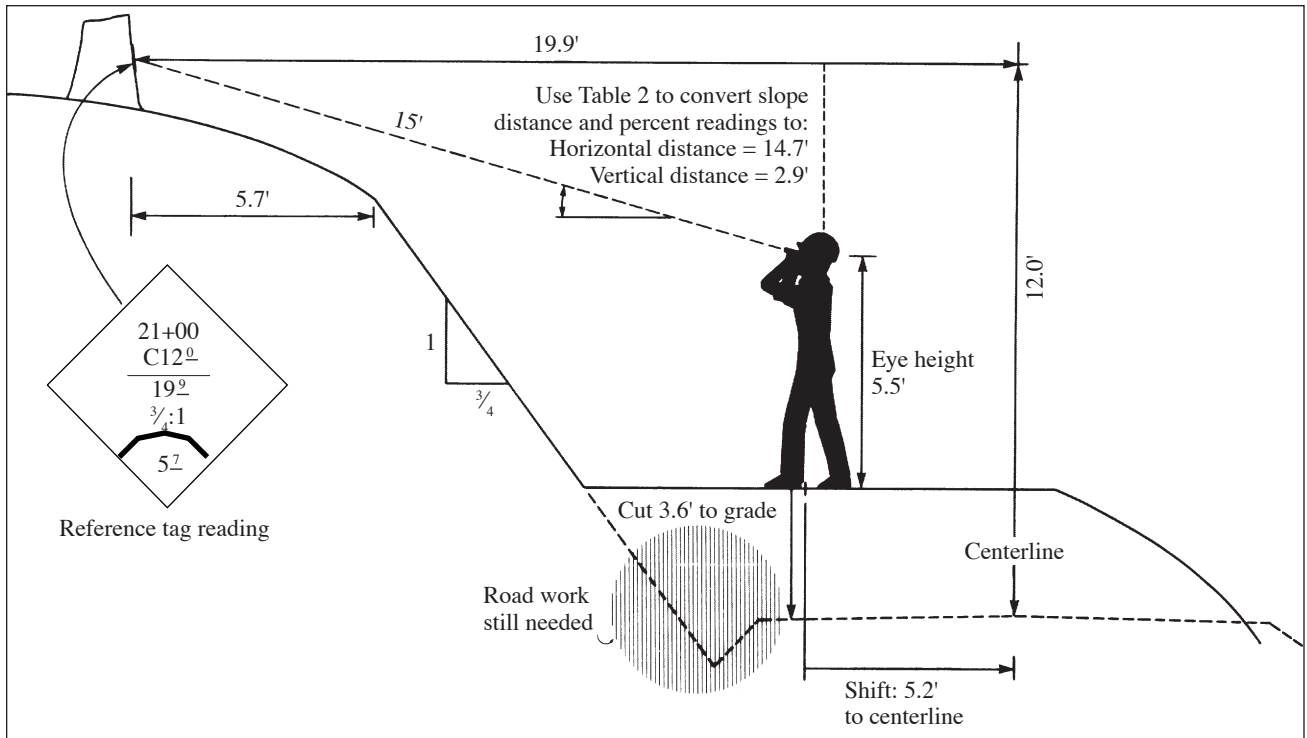

Figure 31.—Checking road grades under construction.

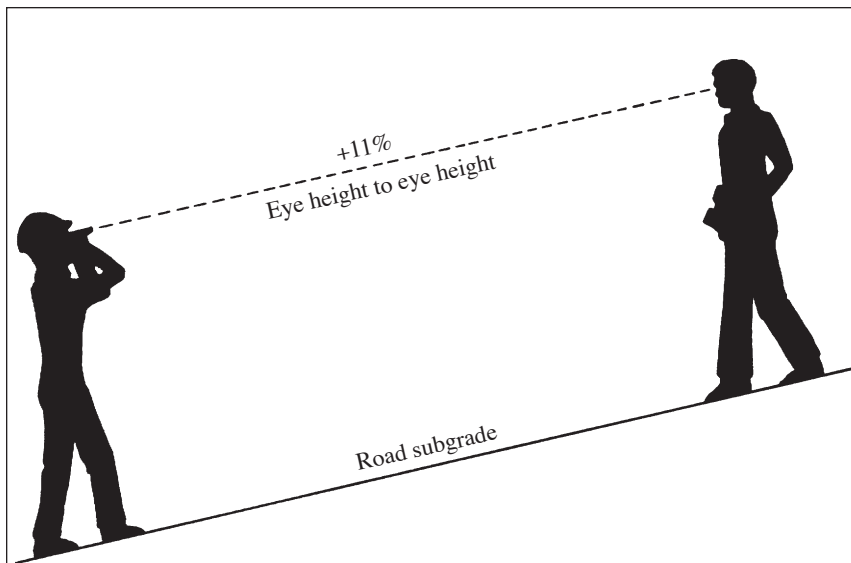

Figure 32.—Checking road grades.

Table 2.—Conversions of slope percentage readings and slope distance to vertical and horizontal distances.

Slope (%)	Slope distance (ft)								
	10'	15'	20'	25'	30'	35'	40'	45'	50'
5	0.5*	0.7	1.0	1.2	1.5	1.7	2.0	2.2	2.5
	10.0*	15.0	20.0	25.0	30.0	35.0	40.0	44.9	49.9
7	0.7	1.0	1.4	1.7	2.1	2.4	2.8	3.1	3.5
	10.0	15.0	20.0	24.9	29.9	34.9	39.9	44.9	49.9
10	1.0	1.5	2.0	2.5	3.0	3.5	4.0	4.5	5.0
	10.0	14.9	19.9	24.9	29.9	34.8	39.8	44.8	49.8
12	1.2	1.8	2.4	3.0	3.6	4.2	4.8	5.4	6.0
	9.9	14.9	19.9	24.8	29.8	34.8	39.7	44.7	49.6
15	1.5	2.2	3.0	3.7	4.5	5.2	5.9	6.7	7.4
	9.9	14.8	19.8	24.7	29.7	34.6	39.6	44.5	49.4
20	2.0	2.9	3.9	4.9	5.9	6.9	7.8	8.8	9.8
	9.8	14.7	19.6	24.5	29.4	34.3	39.2	44.1	49.0
25	2.4	3.6	4.9	6.1	7.3	8.5	9.7	10.9	12.1
	9.7	14.6	19.4	24.3	29.1	34.0	38.8	43.7	48.5
30	2.9	4.3	5.7	7.2	8.6	10.1	11.5	12.9	14.4
	9.6	14.4	19.2	23.9	28.7	33.5	38.3	43.1	47.9
35	3.3	5.0	6.6	8.3	9.9	11.6	13.2	14.9	16.5
	9.4	14.2	18.9	23.6	28.3	33.0	37.8	42.5	47.2
40	3.7	5.6	7.4	9.3	11.1	13.0	14.9	16.7	18.6
	9.3	13.9	18.6	23.2	27.9	32.5	37.1	41.8	46.4
45	4.1	6.2	8.2	10.3	12.3	14.4	16.4	18.5	20.5
	9.1	13.7	18.2	22.8	27.4	31.9	36.5	41.0	45.6
50	4.5	6.7	8.9	11.2	13.4	15.7	17.9	20.1	22.4
	8.9	13.4	17.9	22.4	26.8	31.3	35.8	40.2	44.7
55	4.8	7.2	9.6	12.0	14.5	16.9	19.5	21.7	24.1
	8.8	13.1	17.5	21.9	26.3	30.7	35.0	39.4	43.8
60	5.1	7.7	10.3	12.9	15.4	18.0	20.6	23.2	25.7
	8.6	12.9	17.1	21.4	25.7	30.0	34.3	38.6	42.9

*Read table cells as:

Vertical distance (ft)

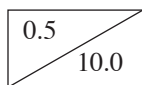

Horizontal distance (ft)

The Woodland Workbook comprises some 60 publications prepared by Oregon State University Extension foresters specifically for owners and managers of private, nonindustrial woodlands. Workbook publications contain information of long-range and day-to-day value for anyone interested in wise management, conservation, and use of woodland properties. Publications are available for purchase separately. For information about how to order, and for a current list of titles and prices, contact the OSU Extension Service office that serves your county. Or, visit Extension's online catalog of educational materials at <http://extension.oregonstate.edu/catalog/>

This publication was produced and distributed in furtherance of the Acts of Congress of May 8 and June 30, 1914. Extension work is a cooperative program of Oregon State University, the U.S. Department of Agriculture, and Oregon counties.

Oregon State University Extension Service offers educational programs, activities, and materials without discrimination based on age, color, disability, gender identity or expression, marital status, national origin, race, religion, sex, sexual orientation, or veteran's status. Oregon State University Extension Service is an Equal Opportunity Employer.