

Figure 4. Inslope road cross-section

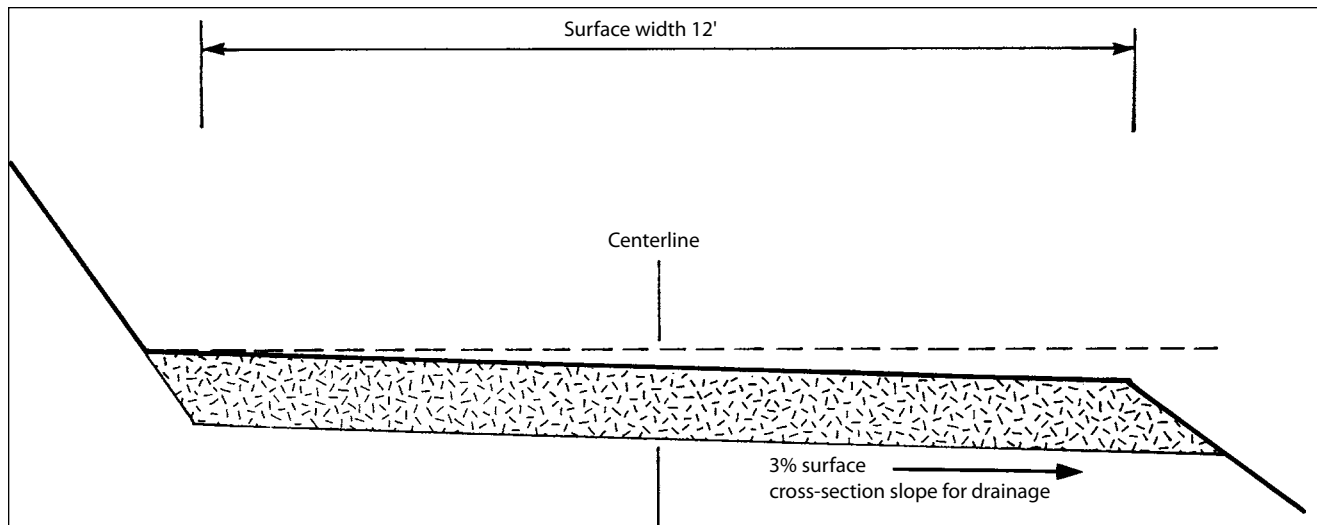

Figure 5. Outslope road cross-section

Full-bench roads and balanced roads

Depending on terrain conditions, woodland roads are mixtures of cut-and-fill construction (see Figures 6, 7, 8, and 9, page 7). You can excavate the road surface from undisturbed, stable soil or build it entirely from fill material.

Full-bench roads are usually built on slopes over 65 percent. The entire running surface is on previously undisturbed (and presumably stable) soil.

You can transport the excavated material to an area needing fill material or to a disposal (waste) area. If the amounts of excavated material are small, relative to the total excavated material, you can sidecast the material along the edge of the road. However, if this practice is abused, landslides and sidecast failures can result, making large land areas unproductive and causing possible environmental issues if the road is adjacent to nearby streams.

A common practice on gentle slopes is to build part of the roadway on a stable bench and use the excavated material to build a portion of the running surface. You can do this by removing all debris and woody material from the side slopes and depositing the clean fill material to minimize road failures.

It is possible to calculate the amount of fill material needed and excavate only the amount for a road cross-section (see Figure 8). Include an allowance for shrinkage that provides additional material.

When the excavated material matches the required fill, the cross-section is balanced. On gentle slopes, balanced sections minimize the amount of earthwork excavation and materials handling.

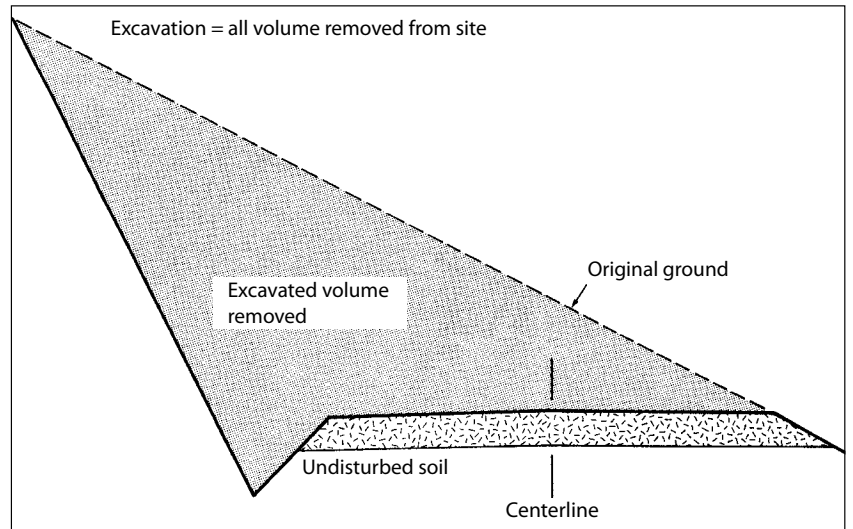

Figure 6. Full-bench road cross-section

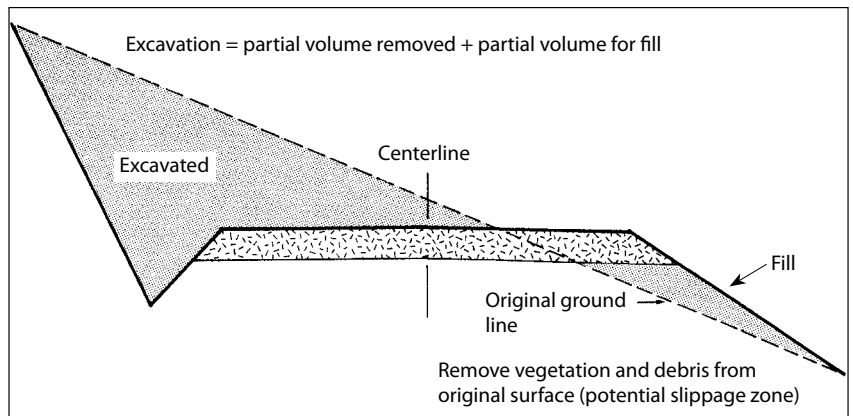

Figure 7. Road cross-section with partial fill

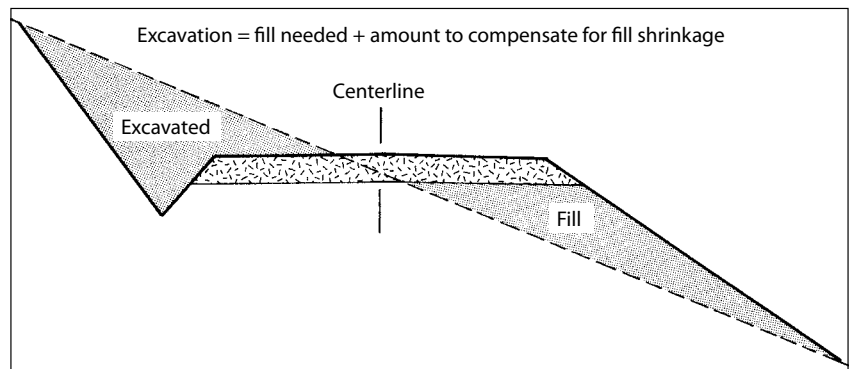

Figure 8. Balanced road cross-section on gentle slope

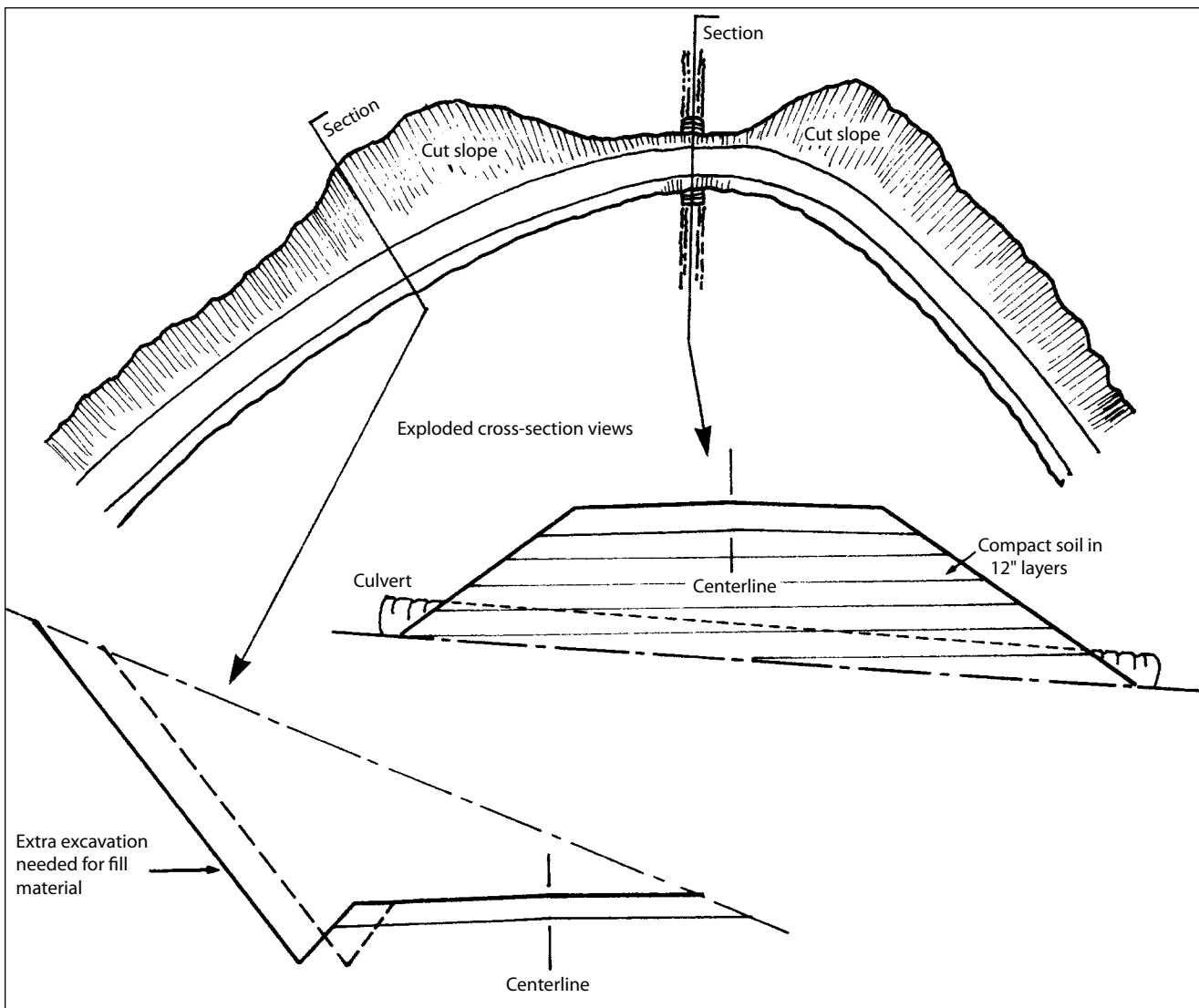

Figure 9. Fill cross-section with extra excavation for fill material

Balanced excavation also describes the length of road where excavated materials must be accumulated for a fill section (see Figure 9). Road design procedures estimate the excess excavation needed on both sides of a fill section to provide material for the fill.

The extra excavation depends on the amount of shrinkage. Also, fill sections often are compacted in layers to develop road strength; thus, the amount of excavation also depends on the degree of compaction of the fill.

Design specifications

Contractors and landowners who build their own roads need design specifications. Depending

on the size of the job, specifications (or “specs,” as they sometimes are called) can be a simple list or pages of contract provisions. The most common specifications are discussed here, along with criteria for deciding which are needed for woodland properties.

Road width

Most landowners want roads as narrow as possible to minimize the cost of construction and the amount of land area removed from production. A 12-foot running surface is usually needed for log truck traffic. If you plan to gravel the road, the subgrade (width of the roadway including ditch) should be at least 14 feet. Curves and two-way traffic

may require widening the road surface in designated segments.

Some large mechanized logging equipment requires a minimum running surface of 14 feet (16-foot subgrade). Also, if you plan to use the road as a landing area, you may need wider sections to allow traffic to pass. Designate landings in advance and widen them during road construction.

Alignment

Alignment is the degree of curvature in the road. Roads should be as straight as possible; however, there are always tradeoffs. If road construction is made easier by adjusting alignment to fit the terrain, the road will have curves. However, there are limits on how sharp the curves can be and still allow log truck traffic.

Measure curves by the radius of curvature. A minimum radius of 50 feet is needed for log trucks (see Figure 10). Another way to measure curves is by using the middle-ordinate method, which requires you make measurements in the middle of the roadway rather than from the center of the circle (see Figure 24, page 19).

Although you can calculate limits of curvature during design, the real test is whether a log truck can pass the curves. If you plan to harvest poles or utilize chip trucks on the property, the curves will need to accommodate the added vehicle length.

Curves in draws or around ridges or switchbacks (horseshoe turns) on a slope are especially critical. You can improve these trouble spots by curve widening, in other words, providing extra road width at critical points along the curve to allow longer trucks (such as those carrying poles) or logging equipment to pass (see Figure 11, page 9).

Road intersections are another element of alignment. Design intersections so that loaded trucks can make the turn easily. The State Highway Division district engineer must approve intersections with public highways. Other considerations include sight distance (clear field of vision for oncoming traffic), distance to other intersections, and intersection width.

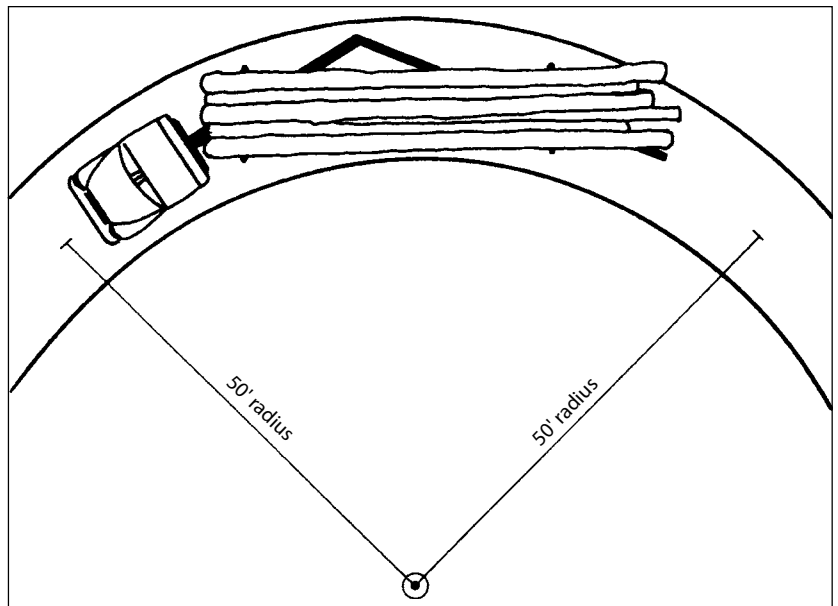

Figure 10. Log truck on a curve with a 50-foot radius

Grades

The slope (grade) of roads is either adverse or favorable. Favorable grades are downhill slopes for loaded trucks and adverse grades are uphill slopes for loaded trucks.

Favorable grades may reach 12 to 15 percent for short distances, while grades of less than 10 percent are recommended for adverse grades. For most road designs, steeper grades are possible under special circumstances, such as terrain conditions where construction and excavation costs become prohibitive. Sharp curves require moderate grades, not greater than 7 percent.

If two grades join on the road, you will need a vertical curve to smooth the transition (Figure 12, page 10). Failure to plan for these transitions can result in truck bind, caused by the limited vertical movement of loaded trucks.

Intersections also are areas where grades are critical. In a location where one road leaves another, you must continue with the original grade for at least 100 feet to make a smooth transition. If the traffic must stop or slow down at an intersection, make the favorable grade low so the vehicle can come to a stop and make the adverse grade low so the vehicle can start out again.

Landing grades must be just steep enough to drain off water. When loaded log trucks leave the

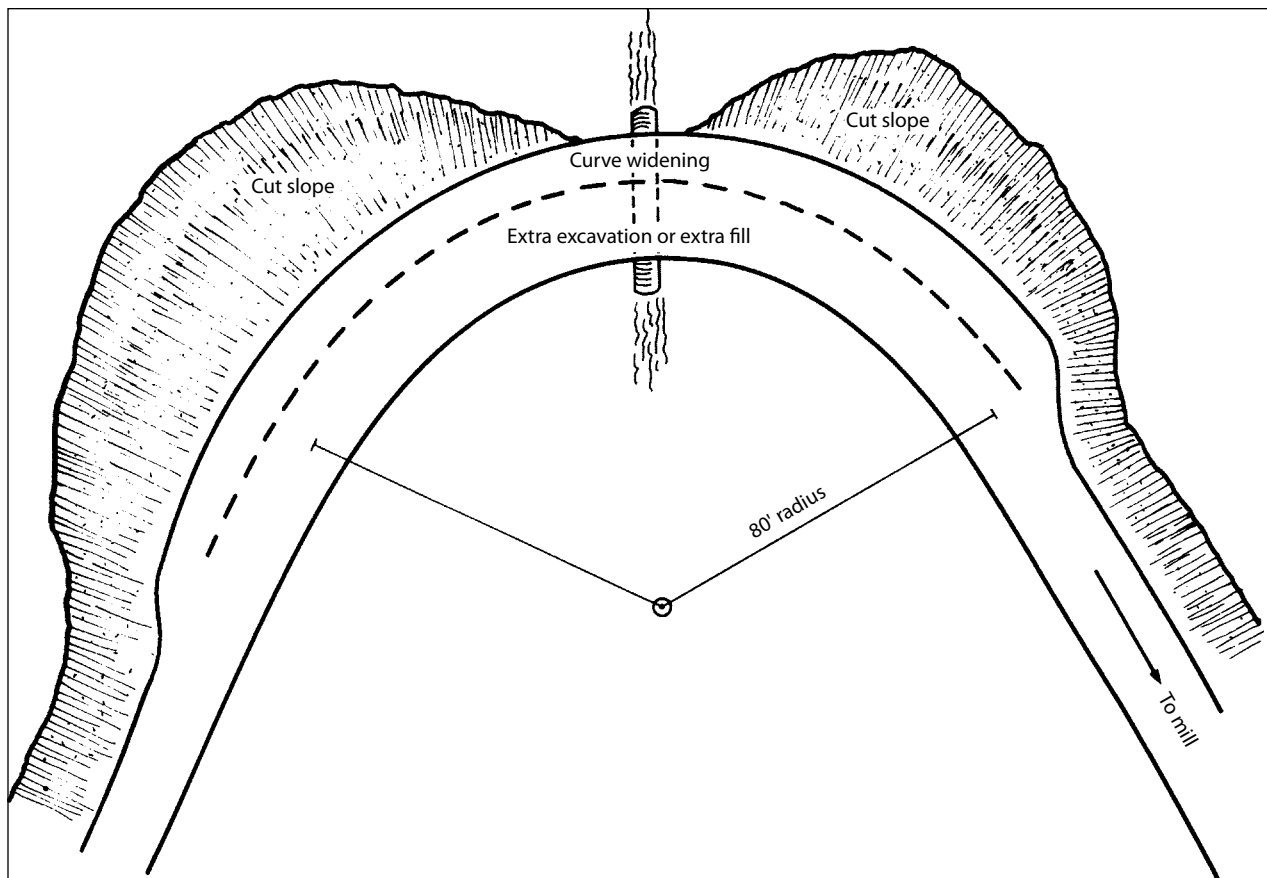

Figure 11. Curve widening to permit truck passage on sharp curves

landing, the grade must be low enough to get them started.

On gentle terrain, road grades may alternate from 2 to 3 percent (where conditions are favorable or adverse) without affecting truck efficiency. Rolling grades (alternate segments of favorable and adverse grades) can help drainage because water velocity does not build up before it drains across the road. On inslope and outslope roads, rolling grades are essential for controlling surface runoff.

Clearing limits

Clearing limits, or right-of-ways, are well-defined areas to be logged before road construction. These areas vary in width and extend about 5 feet beyond the edge of cut slopes or fills. A 30-foot clearing limit is considered a minimum width. Remove vegetation from between the clearing limits and dispose of it outside the roadway, or pile and burn it. Dig stumps out instead of leaving them to rot in the road.

Excavation

Because most forest road construction consists of excavation, the road design must specify how much earth to remove at the centerline of the road and how steep to make the cut slope and fill slopes.

You measure cut slopes opposite the way you measure grades (Figure 13, page 11). For a $\frac{1}{2}$:1 cut slope, the elevation difference is one vertical unit for every $\frac{1}{2}$ unit of horizontal distance.

Cut slopes are designed to match the soil type's ability to hold the slope's steepness. Steep hillside slopes of hardpan soils that are high in clay can hold a $\frac{3}{4}$:1 cut slope, while gentle slopes with loose, non-cohesive soils need a 1:1 cut slope. (Rock can be cut vertically.)

On some steep slopes, a 1:1 cut slope may not be as steep as the adjacent ground slope. However, the cut slope will fail if it is too steep for the soil to hold (Figure 14, page 12).

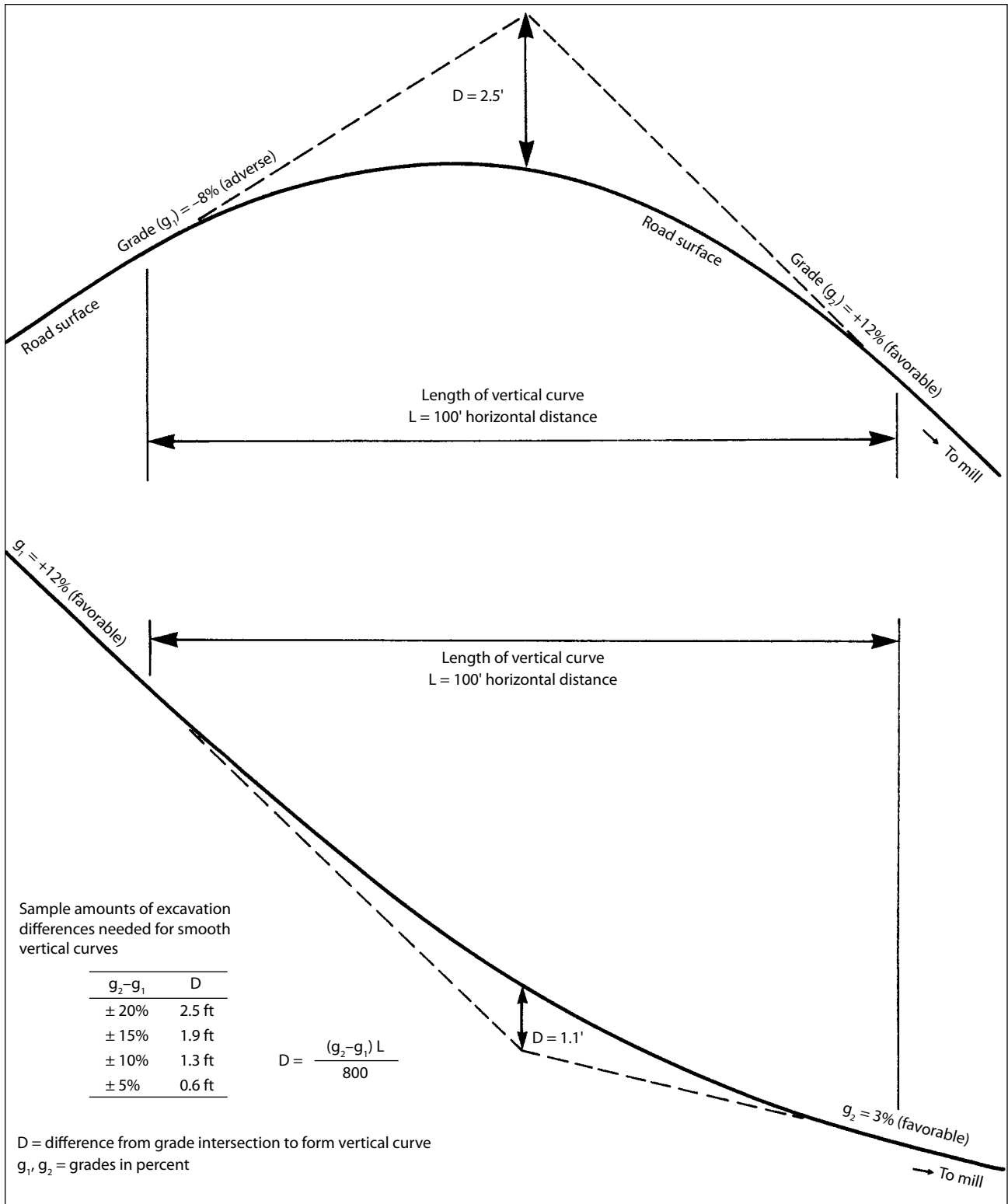

Figure 12. Vertical curves

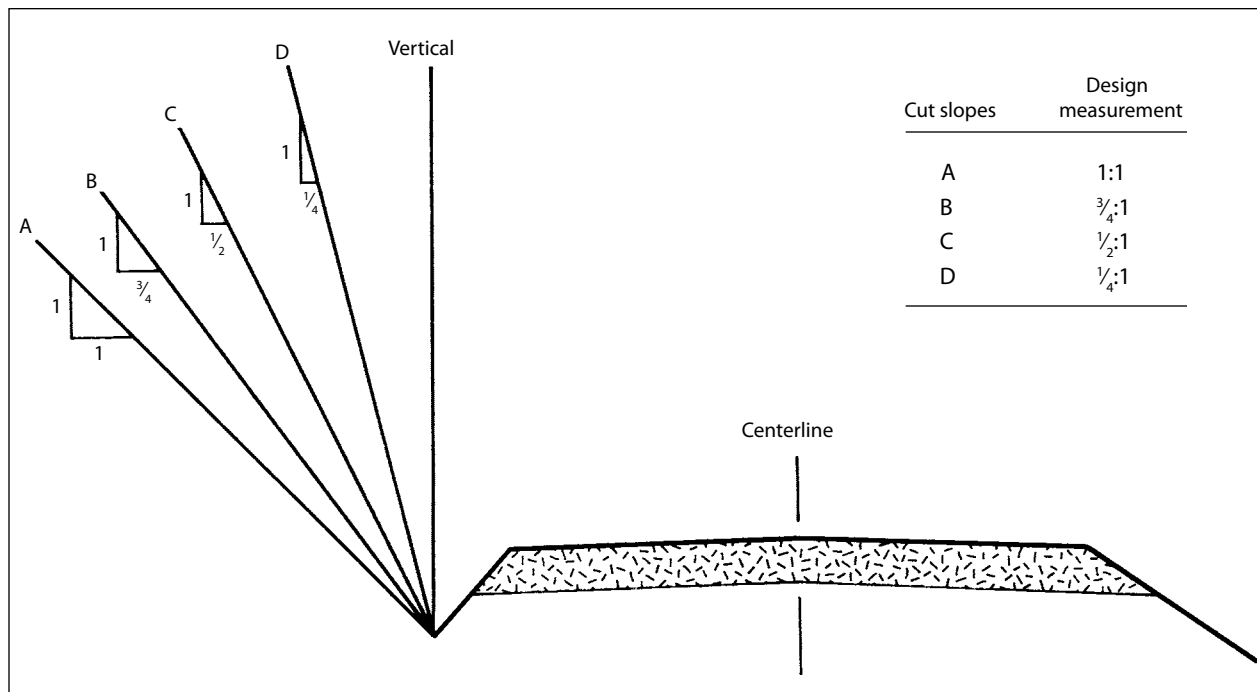

Figure 13. Cut slopes at common steepnesses

Fill slopes also depend on terrain steepness and soil types, but to a lesser degree than cut slopes. Fills usually are designed to have a 1½:1 slope (Figure 15, page 13) because this is the steepness that will hold non-compacted or loose earth. The stability of fills on sloped terrain depends on the original ground's steepness. Fills on slopes that are more than 65 percent will not catch (attach to the original ground) or provide support; material will ravel (slide away) down the hillside (Figure 16, page 13).

Specify where to dump excess excavation in your road design. Waste areas need to be flat and stable. Occasionally, material needed for a fill is unavailable or of poor quality. To compensate, you can include borrow pits (excavations outside the construction area that provide soil and aggregate or both) in your road design.

End hauling is the process of removing material from its excavation site or transporting it to a fill area with a dump truck. While the machines typically used in road construction can move material 200 to 300 feet, it's usually more economical to load the material in dump trucks for hauling. Good road design eliminates or minimizes end hauling.

Occasionally, you can anticipate road surface problems and specify solutions in the road design.

Wet spots are likely to cause problems. You may use special fabrics or dig out the wet material and replace it with rock or better material (e.g., replacing blue clays with sandy soils).

Compaction benefits road subgrades, especially fills. It is common to specify that fills be built up in 12 inch lifts (layers) and compacted each time by the road-building machine. You may need compaction machines if the fill is large or if the soil strength is very low. Consider compacting the entire subgrade if you have to surface the road immediately after construction.

Road structures

You need specifications for all structures that you build into forest roads. This includes bridges and complicated support structures, as well as the often-overlooked culverts and earth-constructed items, such as water bars and dips.

Slope stabilization structures

Under special circumstances, woodland roads may need to cross unstable slopes. You can use structures such as bin walls, sheet piling, rock buttresses, and half bridges, but they likely will require professional assistance in planning and

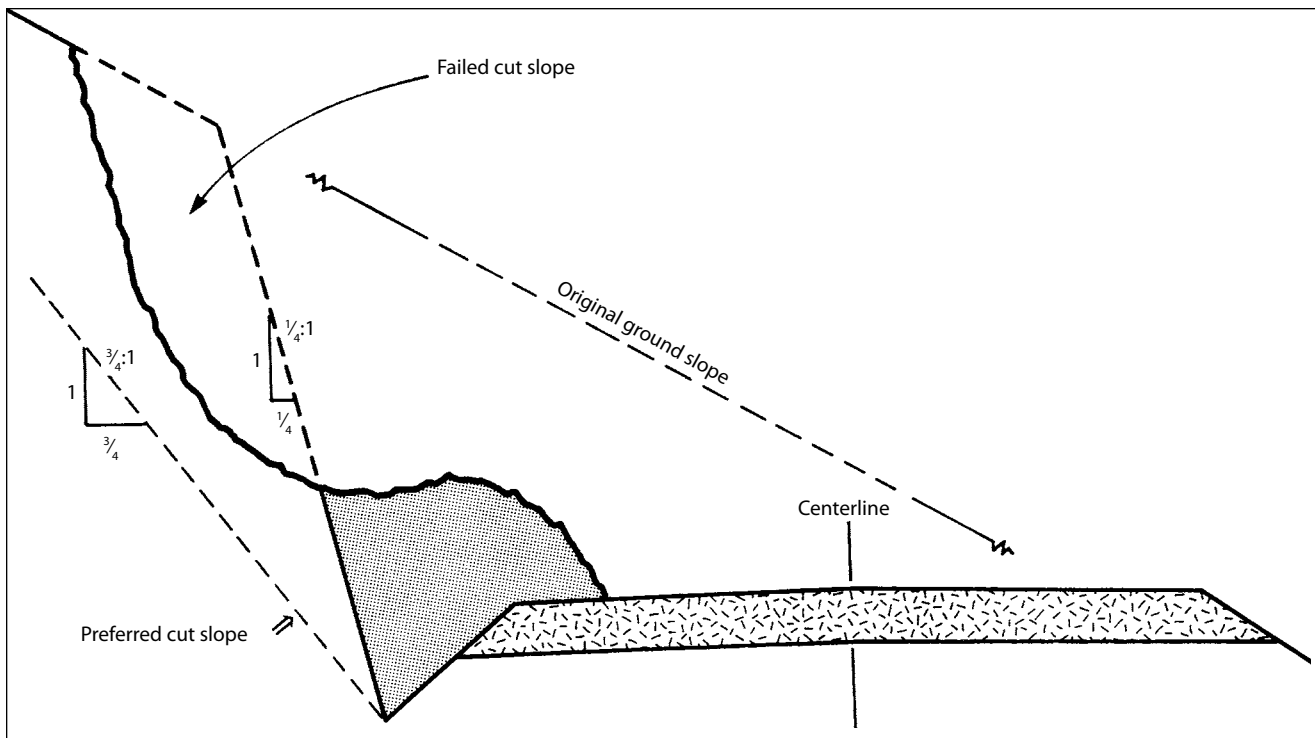

Figure 14. Cut slopes that are too steep may fail.

constructing. Although these structures may cost as much as a bridge, you should be aware that they exist to solve particular slope stability problems, and you should only consider them after exhausting all other options.

Drainage planning

A road that is properly designed and constructed to control water will avoid most maintenance problems. Therefore, the key requirement of a good plan is drainage, drainage, drainage! You will need to design frequent cross drains and stream crossings to control water during storms (Table 1).

Cross drains

Several structures are available for draining water across the road. These range from simple earthwork structures like water bars and rolling dips to open-top, wooden culverts and pipe culverts of various materials. Figures 18, 19, 20, and 21 (pages 14-15) illustrate these options.

When designing cross drain structures, consider where the water will most effectively and efficiently drain across the road. Use outfall protection

measures such as rock riprap (rocks used as armor), culvert half rounds, and water discharged on stable locations to prevent erosion and road undermining. When installing pipe culverts, proper design may eliminate poor-functioning crossings. (continued on page 14)

Table 1. Water bar spacing guide¹

Road grade (%)	Soil type		
	Granitic or sandy (ft)	Shale or gravel (ft)	Clay (ft)
2	900	1,000	1,000
4	600	1,000	800
6	500	1,000	600
8	400	900	500
10	300	800	400
12	200	700	400
15	150	500	300
20	150	300	200
25+	100	200	150

¹Distances are approximate only; vary them to take advantage of natural features. From: *Forest Road Design*. September 2006. Salem: Oregon Department of Forestry.

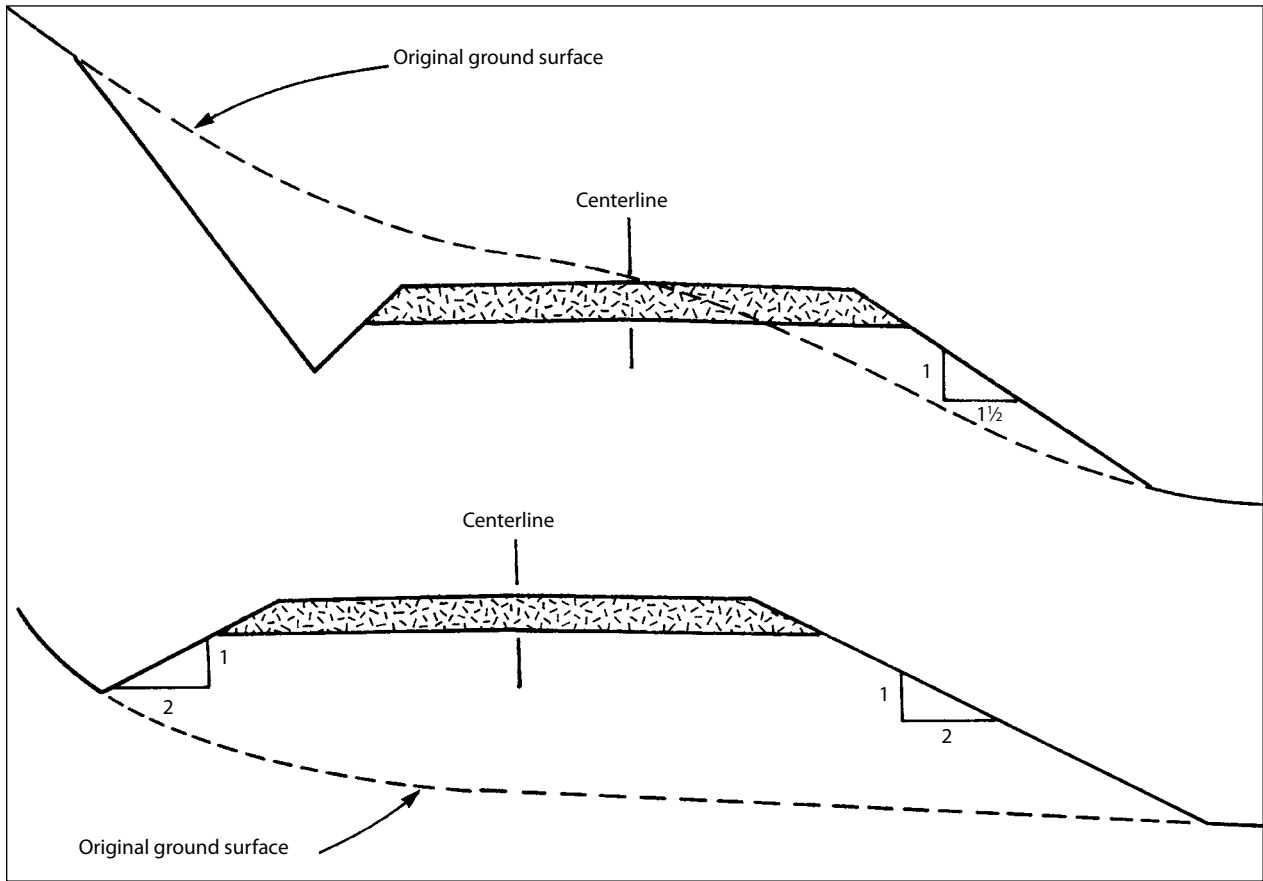

Figure 15. Partial fills at 1 1/2:1 (top) and 2:1 (bottom) fill slopes

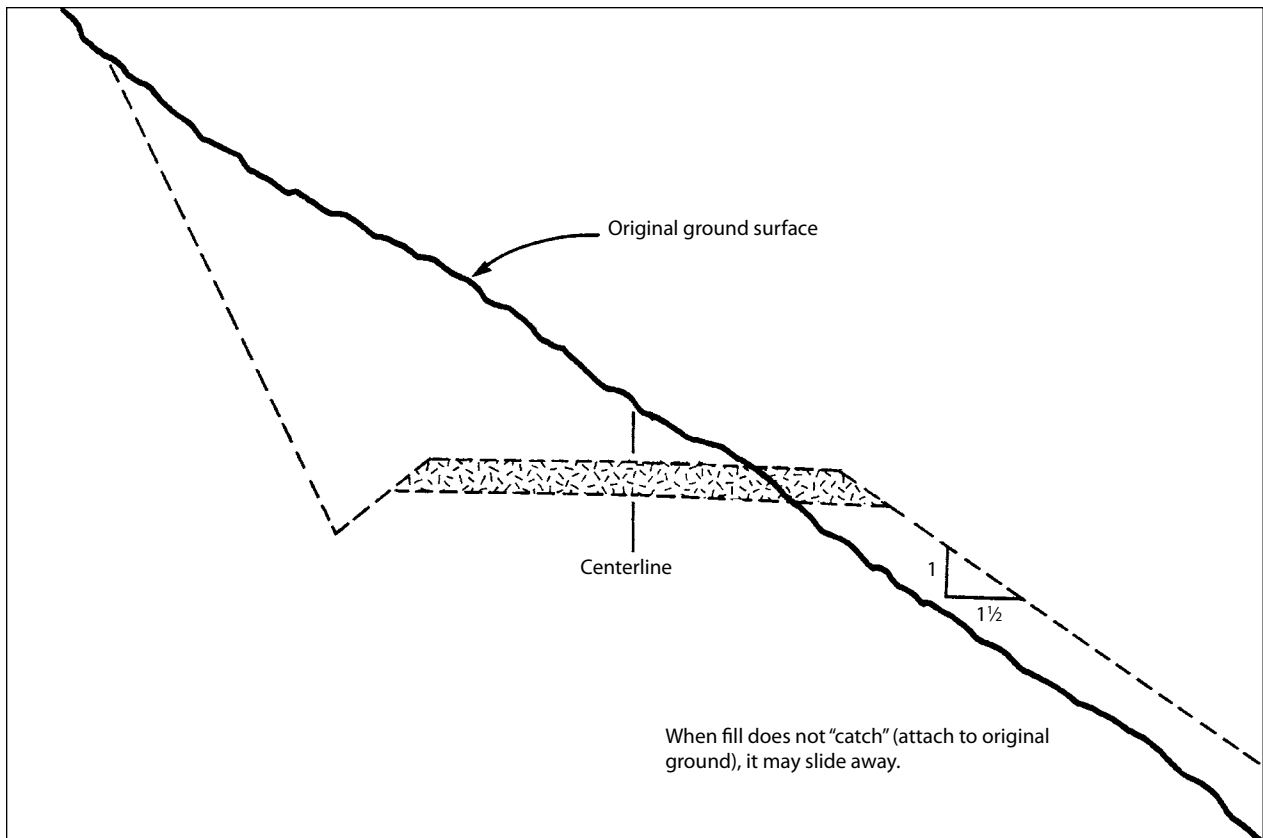

Figure 16. Fill slopes will not catch on steep slopes.

For example, a single larger pipe may be a more effective culvert than several small pipes combined (Figure 17).

Stream crossings

You can use culverts made from steel, aluminum, concrete, or plastic to cross small streams. The size you need depends on local conditions (i.e., rainfall, drainage area, the stream's fish-bearing status, etc.), but an acceptable starting point is to have the area of the culvert opening equal to the area of the stream channel at the historical high water level.

To construct a stream crossing, you need a written plan and consultation with the Oregon Department of Forestry (ODF) in accordance with the rules of the Oregon Forest Practices Act. A Stewardship Forester will assist you in determining whether the stream is fish-bearing. Note: the presence of fish does not determine whether it is labeled a fish-bearing stream. Do not attempt to install a culvert in a stream without proper notification to officials!

In fish bearing streams, culvert design must plan how fish will get into and out of the culvert, as well as the maximum water velocity in the culvert. Such determinations can only be made with professional advice from the Oregon Department of Forestry.

Under some circumstances, you might consider a design that uses pipe arches, bridges, fords, or temporary crossings instead of culverts. Less costly approaches may save money in the short run, but their long-term effectiveness, both environmentally and economically, is the true measure of their success.

Field location and layout

Ribbons, wooden stakes, and metal tags guide the construction of the planned roadway. While there is no single standard or marking system, the information provided in this publication is common to all road construction.

You have to mark the road in a way that the machine operator can understand. If the operator doesn't understand the necessary (continued on page 17)

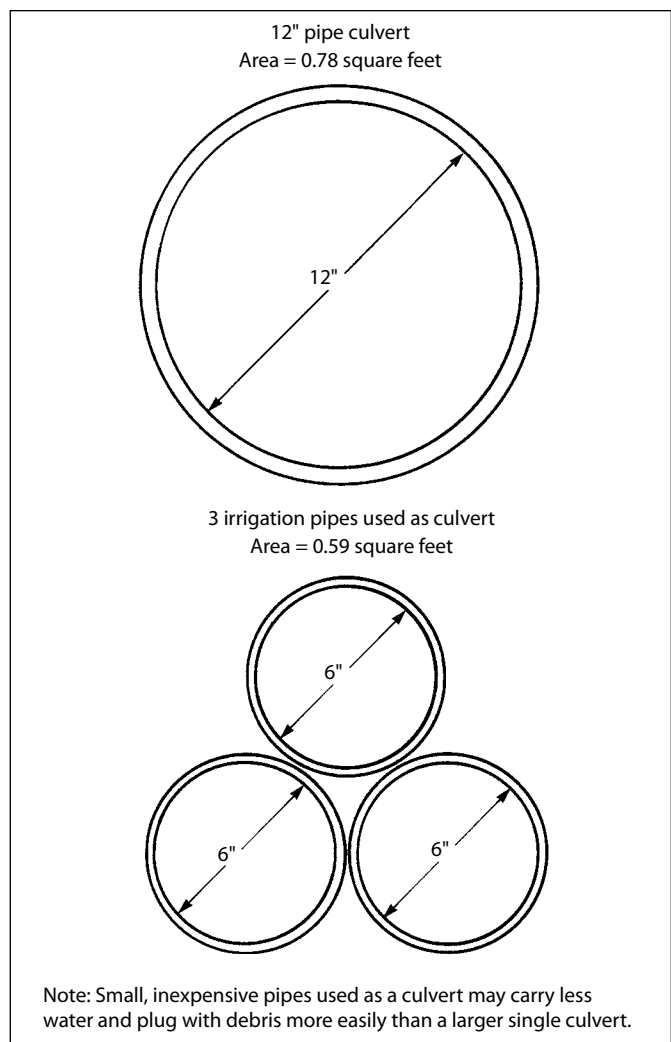

Figure 17. A comparison of three pipes to a single culvert

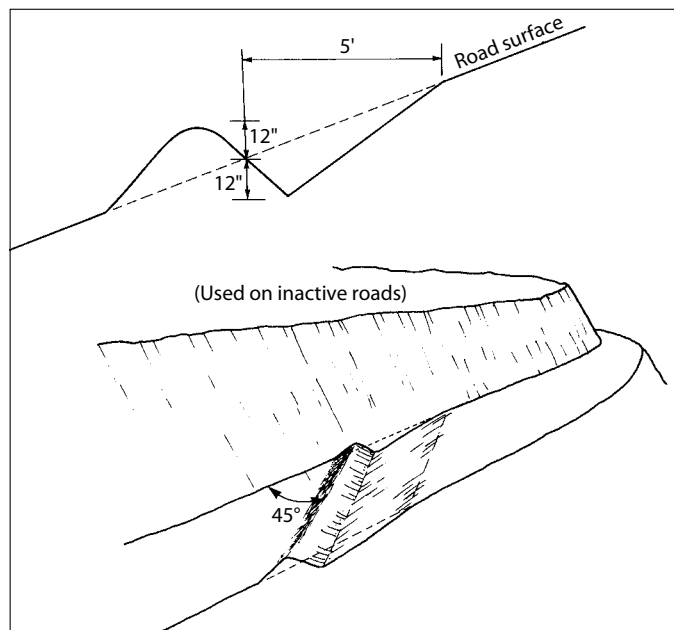

Figure 18. Water bar cross-section and placement (used on inactive roads)

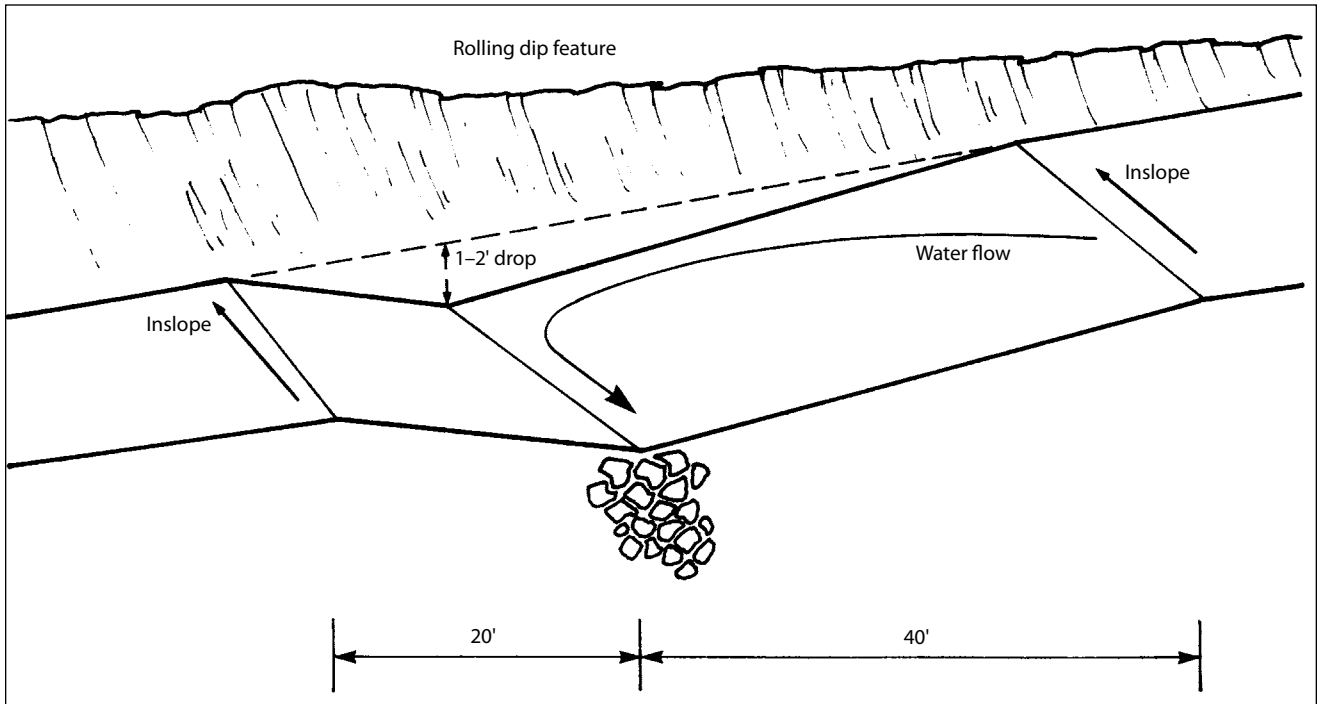

Figure 19. Use a rolling dip to drain surface runoff.

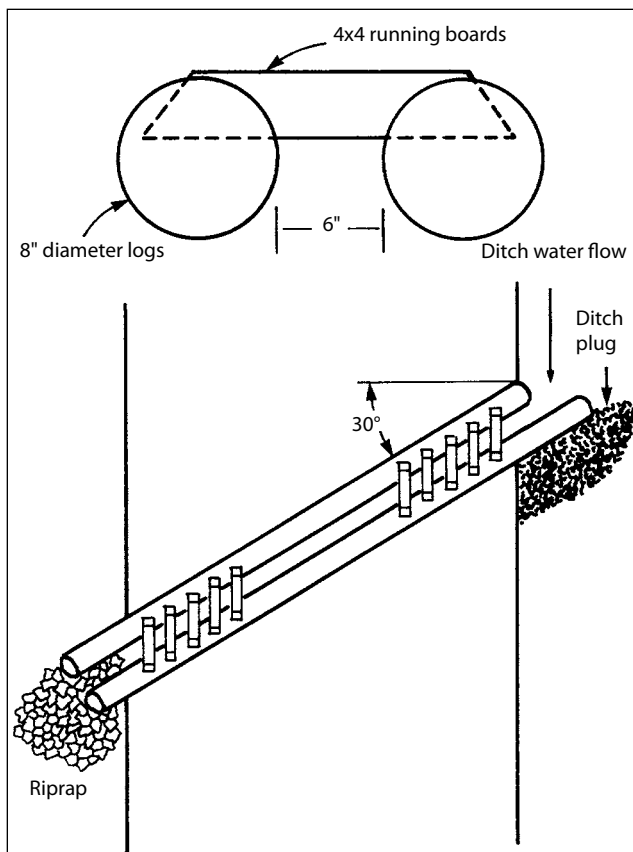

Figure 20. Wooden or steel open-top culvert

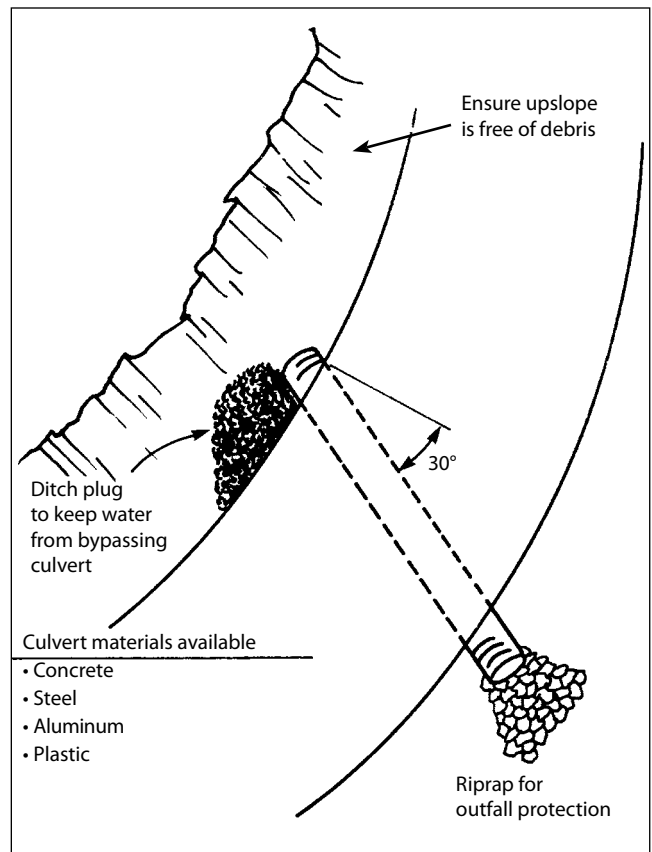

Figure 21. Pipe culvert installation

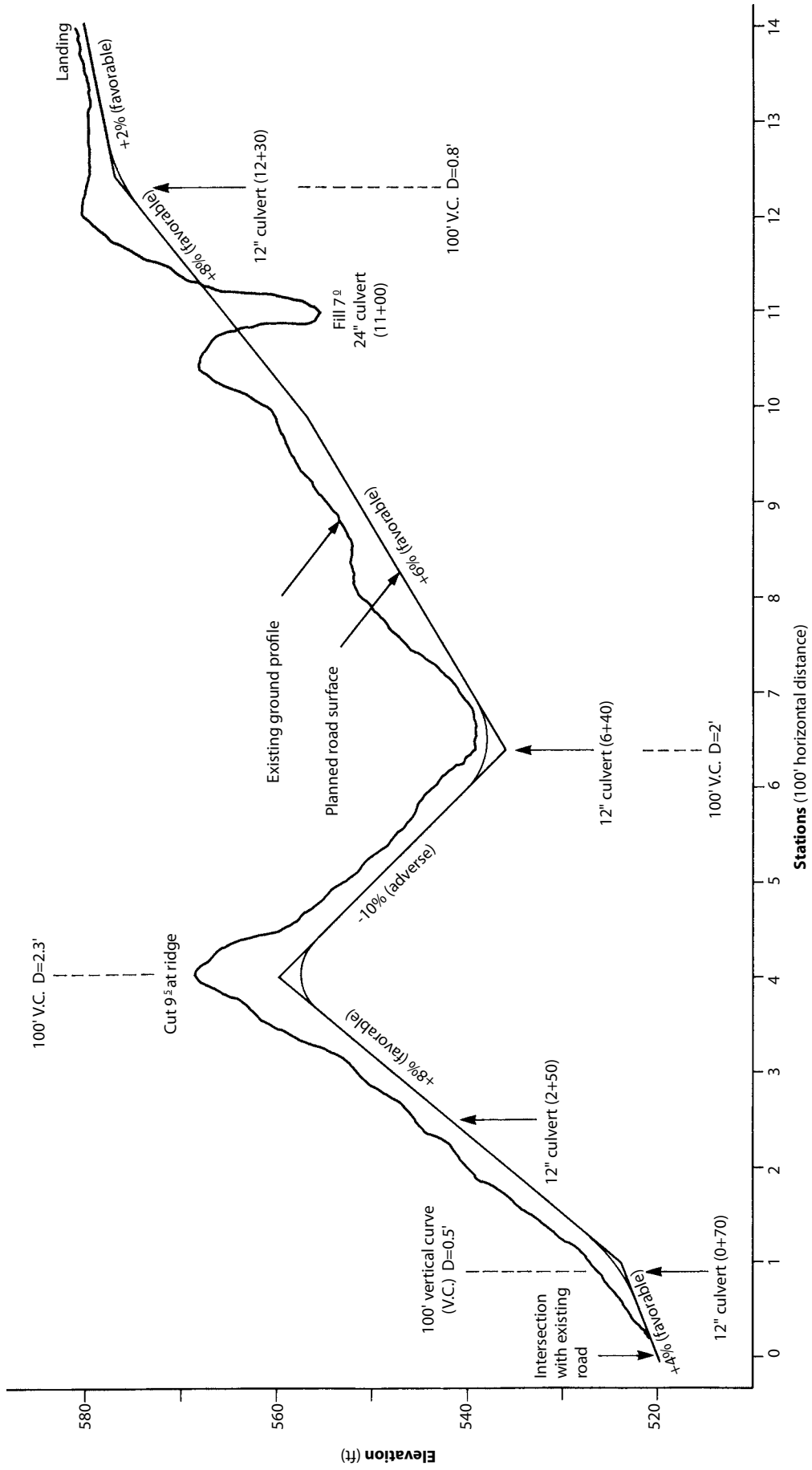

Figure 22. Road profile for construction

information, you or the contractor have to explain it. You or the contractor must also monitor the site and replace the construction stakes (and other markers) that are damaged or destroyed during the construction process. A careful pre-operation review is essential, and construction supervision must be frequent to avoid problems.

Communicating operator information

Establish the right-of-way or clearing limits with ribbons, colored paper tags, or stakes.

Stake the centerline of the road—this is especially critical on curves, switchbacks, and intersections. The operator needs to know where to begin cutting and the slope of the back cut. This information is given on a slope stake, a stake marking the point where the outer limit of a cut or fill meets the original ground. When the operator has this information, cutting or filling can begin at the slope stake, and the proper road width will be achieved at

the same time the road reaches the planned grade elevation.

The machine operator also needs to know how to use the excavated material. A road profile showing ground levels and proposed grades is very useful, if available (Figure 22, page 16). The profile shows where cut and fill sections are located along the road.

You also can use profiles to obtain information on stream crossings, culverts, road cross-drains, and other vital elements of road construction. If a profile is not available from engineering information, a sketch—though less accurate—provides a written form of communication.

The construction crew can avoid future problems with culverts and cross drains through proper installation. Figures 18, 19, 20, and 21 (pages 14-15) are some examples that you can include in specifications or use to communicate with the construction crew.

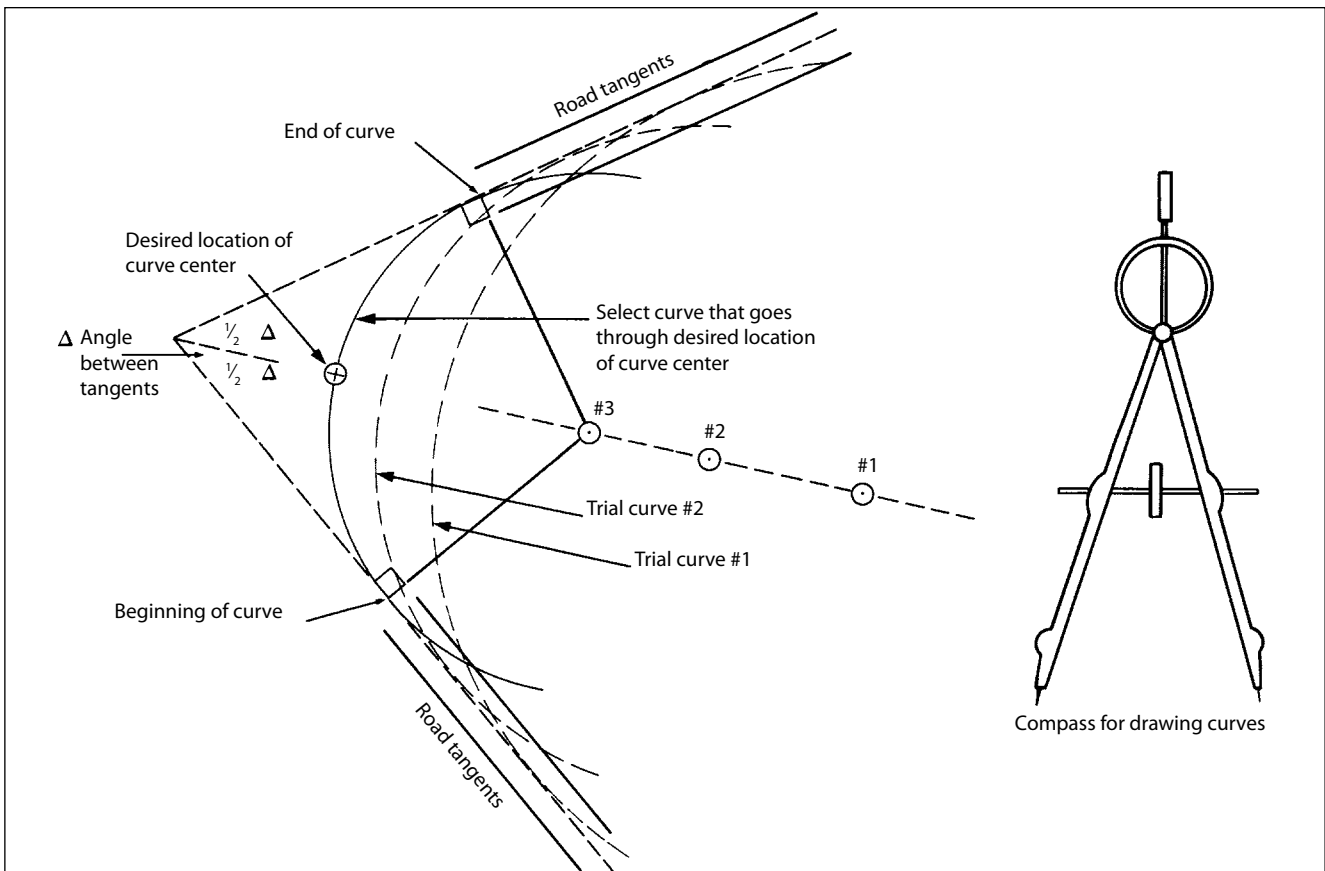

Figure 23. Trial curves with the center of the curve located

Curve layout on woodland roads

Two simple approaches to curve layout are described here, and while they may be adequate for many circumstances (including compound and reverse curves), you may require more involved techniques and professional assistance for complex situations.

Curves frequently connect two straight sections, or tangents, of road. On gentle terrain you can roughly stake these tangents in advance. The line bisecting the angle between the tangents is the line along which the curve will be centered (Figure 23, page 17). When you select the place the road will cross this bisecting line, you can locate the center of (continued on page 20)

Table 2. Conversions of slope percentage readings and slope distance to vertical and horizontal distances

Slope (%)	Slope Distance (ft)								
	10'	15'	20'	25'	30'	35'	40'	45'	50'
5	0.5* 10.0*	0.7 15.0	1.0 20.0	1.2 25.0	1.5 30.0	1.7 35.0	2.0 40.0	2.2 44.9	2.5 49.9
7	0.7 10.0	1.0 15.0	1.4 20.0	1.7 24.9	2.1 29.9	2.4 34.9	2.8 39.9	3.1 44.9	3.5 49.9
10	1.0 10.0	1.5 14.9	2.0 19.9	2.5 24.9	3.0 29.9	3.5 34.8	4.0 39.8	4.5 44.8	5.0 49.8
12	1.2 9.9	1.8 14.9	2.4 19.9	3.0 24.8	3.6 29.8	4.2 34.8	4.8 39.7	5.4 44.7	6.0 49.6
15	1.5 9.9	2.2 14.8	3.0 19.8	3.7 24.7	4.5 29.7	5.2 34.6	5.9 39.6	6.7 44.5	7.4 49.4
20	2.0 9.8	2.9 14.7	3.9 19.6	4.9 24.5	5.9 29.4	6.9 34.3	7.8 39.2	8.8 44.1	9.8 49.0
25	2.4 9.7	3.6 14.6	4.9 19.4	6.1 24.3	7.3 29.1	8.5 34.0	9.7 38.8	10.9 43.7	12.1 48.5
30	2.9 9.6	4.3 14.4	5.7 19.2	7.2 23.9	8.6 28.7	10.1 33.5	11.5 38.3	12.9 43.1	14.4 47.9
35	3.3 9.4	5.0 14.2	6.6 18.9	8.3 23.6	9.9 28.3	11.6 33.0	13.2 37.8	14.9 42.5	16.5 47.2
40	3.7 9.3	5.6 13.9	7.4 18.6	9.3 23.2	11.1 27.9	13.0 32.5	14.9 37.1	16.7 41.8	18.6 46.4
45	4.1 9.1	6.2 13.7	8.2 18.2	10.3 22.8	12.3 27.4	14.4 31.9	16.4 36.5	18.5 41.0	20.5 45.6
50	4.5 8.9	6.7 13.4	8.9 17.9	11.2 22.4	13.4 26.8	15.7 31.3	17.9 35.8	20.1 40.2	22.4 44.7
55	4.8 8.8	7.2 13.1	9.6 17.5	12.0 21.9	14.5 26.3	16.9 30.7	19.5 35.0	21.7 39.4	24.1 43.8
60	5.1 8.6	7.7 12.9	10.3 17.1	12.9 21.4	15.4 25.7	18.0 30.0	20.6 34.3	23.2 38.6	25.7 42.9

*Read table cells as:

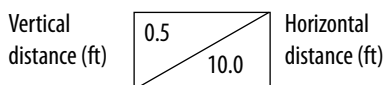

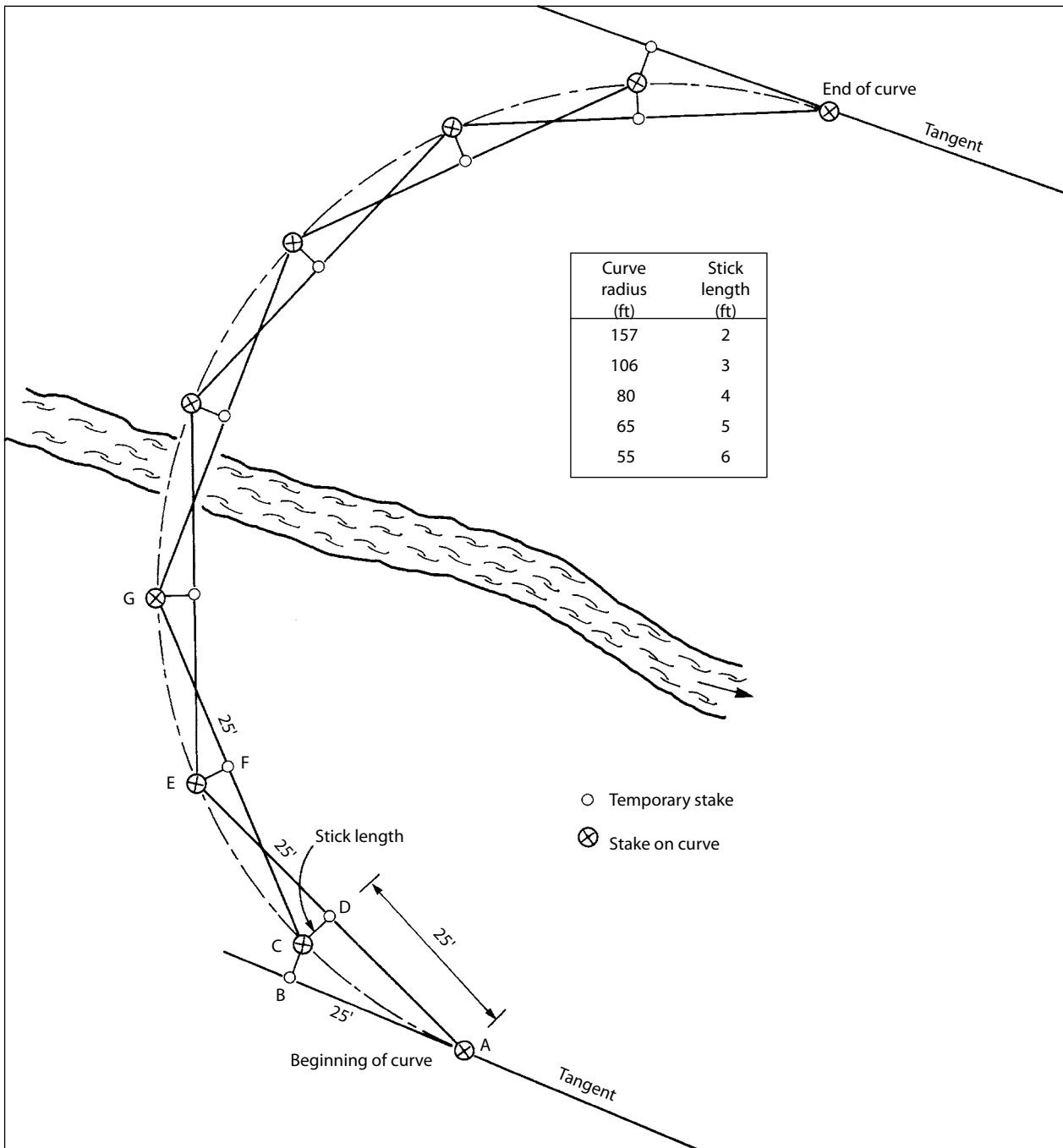

Figure 24. The middle-ordinate curve-location method

Follow the steps below to lay out a curve using the middle-ordinate (stick-length) method. Assign letters to the stakes you use for layout. Once a curve fits a given location, mark the stations on the stakes starting from the beginning of the curve (for example, if stake A = station 12+10, and stakes are used every 25 feet, then stake C would be marked 12+35; stake E, 12+60; and so forth). All distances are horizontal measurements (they are not on the slope).

1. Select the desired radius curve and the corresponding stick length to use.
2. From stake A, measure 25 feet to B, extending the tangent line at the beginning of the curve. At right angles to the tangent, set stake C one stick length from the tangent. You now have the first stake on the curve.
3. At C, measure off the stick length toward the center of the curve and set temporary stake D. From A, sight through D and measure off 25 feet from D to set stake E (another stake on the curve).
4. At E, measure a stick length toward the center of the curve and set temporary stake F. From C, sight through F and measure off 25 feet from F to set stake G on the curve.
5. Repeat these steps until you approach the tangent for the end of the curve.
6. If the curve does not fit on the first trial, you have several options to fit the curve.
 - Change the stick length (and thus the curve radius). A longer stick makes a sharper curve; a shorter stick makes a curve of larger radius.
 - Start the curve earlier than stake A or later (at B) to fit the topography.
 - Try combinations of various starting points and stick lengths.

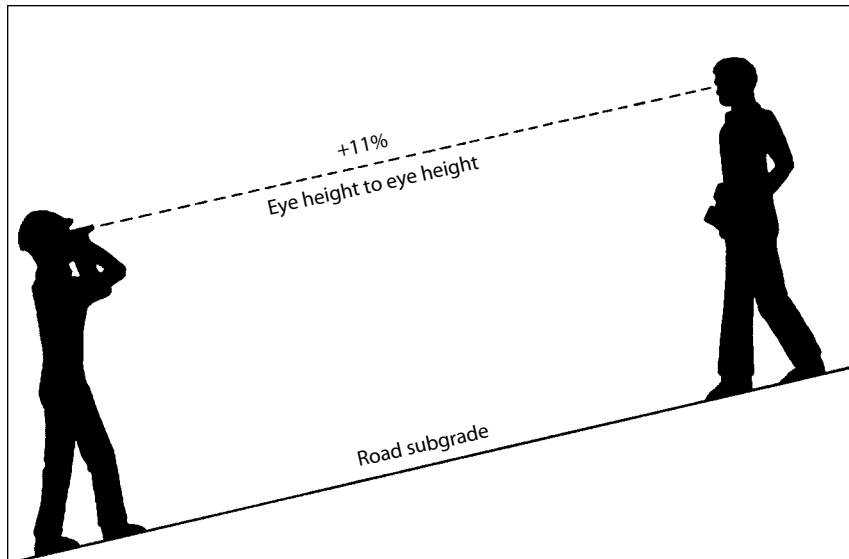

Figure 25. Checking road grades

the curve by trial and error. The correct radius curve will just touch the centerline of each tangent and will “curve” through the area you want the road to cross. For practice, try this on paper with a compass.

In the field, once you locate the center of the curve, you can use two tapes or measured ropes to find the stations along the curve. On more difficult terrain, such as sharp draws, ridges, and hillside switchbacks, it may be impossible to locate the center of the curve. In these cases you can use the middle-ordinate (stick length) layout system. This system may be easier to use than locating the center of the curve. Figure 24 (page 19) provides a procedural approach; however, you should be aware that several trials may be necessary to get the curve to fit.

During the process of road construction, it’s useful to restake the difficult curves after completing the right-of-way logging. The machine operator will then be able to construct curves at the proper, designated locations.

Checking road construction

The time and effort you invest in careful road design will be lost if your design is not reflected in construction practices. Thus, it is essential to check on road construction frequently to verify, for

example, that the road is at the planned grade, curve radii are being satisfied, and the centerline is in the correct position.

Consider this example: your road is under construction but is not yet ready to grade. You can monitor progress using two approaches. First, you can use a hand level to check the amount of cutting (or filling) completed. Or second, you can use a clinometer (a device for measuring slope) and convert the percent reading, along with the slope distance, to vertical and horizontal measurements. (See Table 2, page 18, to convert slope readings and slope distances to vertical and horizontal distances.) Clinometers also give direct readings on road grades between two points on the road (Figure 25). Critical places to check are curves (especially vertical ones), switchbacks, intersections, and steep segments. Using either of these two methods, you then can reestablish the centerline and leave a stake to tell the operator how much more cutting (or filling) is needed, in the event there are necessary adjustments in the road design.

Monitoring road construction does not mean rigid adherence to field-location guidelines; the road construction process is not exact. Grades within ± 1 percent and excavation to the nearest foot usually are acceptable. The most important criterion is whether the road will serve the intended function.

Good construction can improve road design. However, failing to construct portions of the road within acceptable variances of the design specifications and ignoring the field layout and location markers can result in roads that are problems for trucking and maintenance activities.

Summary

Road specifications and field layout and location are the essence of road design. You may wish to design simple and small scale road building projects or seek out professional service for bigger, more complex projects. The information provided in this publication will help you design your own road or supervise those providing contract services.

For more information

There are a number of other helpful publications available on various topics related to the management of a timber sale.

OSU Extension Service publications

- *Contracts for Woodland Owners and Christmas Tree Growers* (EC 1192) describes how to develop a contract and includes samples of four types of agreements: timber sale, logging, temporary road use, and road easement.
- *Grass Seeding Forest Roads, Skid Trails, and Landings in the Inland Northwest* (PNW 628) outlines strategies for establishing vegetation to stabilize erodible areas along forest roads and skid trails.

Other publications

Managing Woodland Roads: A Field Handbook discusses the major aspects of woodland roads relating to their design, inspection, maintenance, and repair. (Oregon State University, 2006).