

©1998 IEEE. Personal use of this material is permitted. However, permission to reprint/republish this material for advertising or promotional purposes or for creating new collective works for resale or redistribution to servers or lists, or to reuse any copyrighted component of this work in other works must be obtained from the IEEE.

An Overview of MODIS Capabilities for Ocean Science Observations

Wayne E. Esaias, Mark R. Abbott, Ian Barton, Otis B. Brown, Janet W. Campbell, Kendall L. Carder, Dennis K. Clark, Robert H. Evans, Frank E. Hoge, Howard R. Gordon, William M. Balch, Richard Letelier, and Peter J. Minnett

Abstract—The Moderate Resolution Imaging Spectroradiometer (MODIS) will add a significant new capability for investigating the 70% of the earth's surface that is covered by oceans, in addition to contributing to the continuation of a decadal scale time series necessary for climate change assessment in the oceans. Sensor capabilities of particular importance for improving the accuracy of ocean products include high SNR and high stability for narrower spectral bands, improved onboard radiometric calibration and stability monitoring, and improved science data product algorithms. Spectral bands for resolving solar-stimulated chlorophyll fluorescence and a split window in the 4- μ m region for SST will result in important new global ocean science products for biology and physics. MODIS will return full global data at 1-km resolution. The complete suite of Levels 2 and 3 ocean products is reviewed, and many areas where MODIS data are expected to make significant, new contributions to the enhanced understanding of the oceans' role in understanding climate change are discussed. In providing a highly complementary and consistent set of observations of terrestrial, atmospheric, and ocean observations, MODIS data will provide important new information on the interactions between earth's major components.

I. INTRODUCTION

USE OF satellite image data to investigate oceanic processes has become an essential component of oceanographic research and monitoring. Data from the Coastal Zone Color Scanner (CZCS) provided the first demonstration of the ability to observe the abundance and distribution of phyto-

plankton chlorophyll in the world's ocean from space [42], [81], [105]. The data have been used extensively to gain better understanding of marine food webs and the role of the ocean in important biogeochemical cycles, including carbon and nitrogen. The near synoptic and global data provided by polar orbiting satellites fill a fundamental need for ocean scientists, since conventional platforms cannot adequately cover the vast, rapidly varying ocean at the appropriate time and space scales [37]. As a result of the importance of synoptic global observations in studying the marine biosphere [81], the United States is in the process of implementing three flight missions within four years that will deliver global ocean color data—SeaWiFS (July 1997), Moderate Resolution Imaging Spectroradiometer (MODIS) Earth Observing System (EOS)-AM1 (summer 1998), and MODIS EOS-PM1 (December 2000). These missions have been designed to serve the same research community, with respect to ocean color, and the overall mission requirements have been highly congruent, while representing an evolution in capability. A primary objective of these missions is to obtain a highly consistent time series of observations useful for understanding the role of the ocean biosphere in the earth system at seasonal-to-decadal time scales.

Data from the Advanced Very High Resolution Radiometer (AVHRR), in use operationally since 1981, have provided kilometer-scale estimates of bulk sea surface temperature that are extensively used to study upper ocean dynamics, air-sea fluxes of heat and moisture, and the coupling between biological and physical ocean dynamics.

The MODIS sensors fill both the basic needs established for SST and ocean color as well as provide advancement in critical capability necessary for decadal time series. Improvements in SNR, band spectral and radiometric performance and characterization, and calibration stability monitoring have been given emphasis [8], [62], [95]. On the product side, improved spatial and temporal coverage, with the addition of new, validated products, are key goals. The purpose of this paper is to highlight the improved capabilities of the current MODIS sensors in relation to the scientific objective and algorithm development to discuss major product characteristics and mention some important areas of postlaunch validation and research.

II. COMPARISONS WITH PRECURSOR SENSORS IN THE VISIBLE

In the visible region, MODIS builds upon the CZCS and SeaWiFS heritage. Two major exceptions to this are that the

Manuscript received November 5, 1997, revised March 17, 1998. This work was supported by the MODIS Instrument Team Funding from the EOS Project, Mission to Planet Earth.

W. E. Esaias is with the Oceans and Ice Branch, Code 971, Goddard Space Flight Center, Greenbelt, MD 20777 USA (e-mail: wayne.esaias@gsfc.nasa.gov).

M. R. Abbott and R. Letelier are with the School of Oceanography, Oregon State University, Corvallis, OR 97331 USA.

I. Barton is with CSIRO Marine Labs, Tasmania, 7001 Australia.

O. B. Brown, R. H. Evans, and P. J. Minnett are with the Division of Meteorology and Physical Oceanography, Rosenstiel School of Marine and Atmospheric Science, University of Miami, Coral Gables, FL 33149 USA.

J. W. Campbell is with MPTE, Code YS, NASA Headquarters, Washington, DC 20546 USA.

K. L. Carder is with the Department of Oceanography, University of South Florida, Tampa, FL 33620 USA.

D. K. Clark is with the Oceanic Research and Applications Division, National Oceanic and Atmospheric Administration, Camp Springs, MD 20746 USA.

F. E. Hoge is with the Wallops Flight Facility, Code 975, Goddard Space Flight Center, Wallops Island, VA 23337.

H. R. Gordon is with the Department of Physics, University of Miami, Coral Gables, FL 33149 USA.

W. M. Balch is with the Bigelow Laboratory for Ocean Sciences, West Boothbay Harbor, ME 04575 USA.

Publisher Item Identifier S 0196-2892(98)04752-4.

sensor does not tilt and the instrument is designed to provide quantitative measurements of solar-stimulated fluorescence from chlorophyll *a*. Emphasis has been placed on the ability to monitor sensor calibration and stability through the use of multiple onboard calibrators [including spectral response for the visible and near infrared (VIS-NIR) channels] and by solar and lunar observations to decrease the uncertainty due to instrumental effects in observed trends of geophysical products [38], [61].

The advantage of a tilting sensor is to achieve greater useful global coverage because the direct, specular reflection of the sun can be avoided through tilt changes. However, studies by Gregg [59] and Gregg and Woodward [61] indicate that two nadir instruments collecting data simultaneously, such as planned for Earth Observing System (EOS)-AM1 and EOS-PM1 missions, give approximately equivalent global coverage frequency as a single-tilting sensor. Therefore, coverage frequency of the ocean using combined data from the AM1 and PM1 sensor should be sufficient to observe the important fluctuations in phytoplankton dynamics.

The ocean color bands on MODIS are very similar to SeaWiFS bands, with the advantage that they are narrower than SeaWiFS, a result of the large aperture and throughput of MODIS. The narrower bands will enhance atmospheric correction. For example, the ocean band at 748 nm is about half the width of the equivalent SeaWiFS band and, therefore, avoids the nearby atmospheric oxygen absorption feature altogether. Bands 8 and 9 have 15-nm width to achieve needed SNR. MODIS band 11 at 531-nm exhibits the largest band difference from SeaWiFS positions. The analogous SeaWiFS band position is at 510 nm, due to the location of the SeaWiFS dichroic beamsplitter [7]. A center wavelength of 531 nm was selected for MODIS to improve the response to accessory pigments, rather than maintain continuity with precursor sensors. Also, there is less spectral structure in this region, and therefore, slight on orbit will not significantly affect radiometric calibration.

The positions of the primary ocean color bands are given in Fig. 1 as bars covering the bandwidth and plotted at the noise-equivalent delta radiance values (NEDL) for each band. Exact band shapes are illustrated in Barnes *et al.* [8]. Also shown on this figure are modeled top-of-atmosphere (TOA) and bottom-of-atmosphere (BOA) (just above the ocean surface) signals over the ocean for extremely low and extremely high chlorophyll concentration. Note that the two lines for TOA values are virtually congruent, indicative of the very small radiance differences that must be detected by the sensor. Modeled radiance values show nearly the full dynamic range of oceanic chlorophyll concentration of interest. The position of MODIS high-resolution bands, which might prove useful for ocean color observations, are also indicated.

The SNR is one of the key scientific requirements and is carefully specified for ocean color sensors, due to the fact that the oceans are quite dark. Water-leaving radiance values are commonly less than 10% of the total radiance measured at the sensor and are often less than 1%. The scientific requirements for various sensors have increased from CZCS to MODIS, based on demonstrated need for higher precision and accuracy

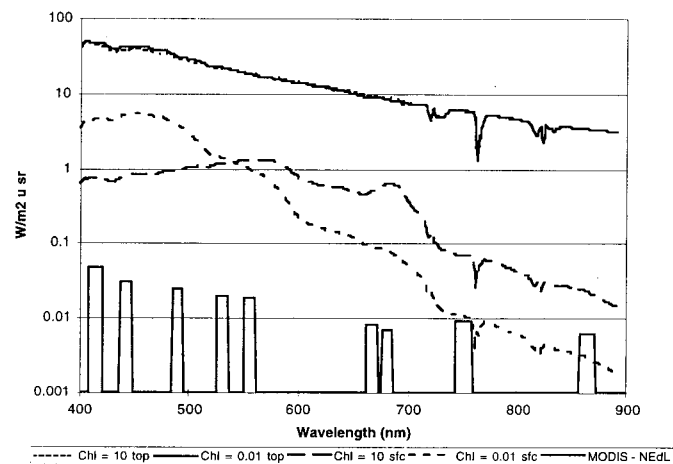

Fig. 1. Upwelling radiance at the TOA and at the ocean surface for extremely low- and very high-oceanic chlorophyll *a* concentrations. (four lines from top to bottom on left are TOA: 0.01 mg/m³, TOA: 10 mg/m³, surface: 0.01 mg/m³, and surface: 10 mg/m³). Model radiances simulate a nadir view at 60° solar zenith angle, or a clear atmosphere with an aerosol optical depth at 670 nm of 0.2, Angstrom exponent of 0.5, 5-mm precipitable water, and 0.35-cm ozone. Measured values of Noise-Equivalent Delta Radiance (NEDL) for MODIS bands 8–16 are shown as bars.

at very low chlorophyll levels to address vast open ocean provinces and accommodate improvements in atmospheric and bio-optical algorithms. The principles used to determine required SNR for SeaWiFS and MODIS are comparable, and differ primarily only in the amount of total error allocated to the sensor compared to the error in the atmospheric correction and in-water algorithms for chlorophyll. All contribute to the total error in derived chlorophyll pigment concentration, which is compared to CZCS experience. This has been discussed in some detail by Gordon and Wang [57]. Briefly, the specified SNR for the SeaWiFS sensor was based on equalizing error contributions in derived chlorophyll concentrations from 1) the sensor and 1) the CZCS algorithms. The MODIS SNR specifications are more stringent to reduce sensor-induced errors when applying much improved geophysical algorithms developed for SeaWiFS and MODIS.

Large differences in the radiance value at which required SNR was specified exist between various sensors. Because SNR is an instrument-specific, nonlinear function of input radiance, direct comparison of minimum SNR specification values for various instruments without reference to the input radiance at which it is measured can be misleading. Table I shows the ocean band center wavelengths, specified SNR, and the input radiance (L_{in}) at which the SNR is required for the three ocean color sensors. Included are specifications for four higher resolution bands (500-m bands 3 and 4 at 470 and 555 nm and the 250-m bands 1 and 2 at 670 and 865 nm, respectively). Different L_{in} values were used in specifications because different radiative transfer and algorithm models and viewing geometries were used in analyses. Pixels near the edge of the swath (which are brighter than at nadir) with a 20° solar zenith were chosen as the arbitrary reference for SeaWiFS specifications, resulting in specifying SNR at relatively high L_{in} values, while pixels near nadir at a lower sun angle were used in model studies for MODIS.

TABLE I
INPUT RADIANCES AND SNR'S FOR OCEAN BANDS ON UNITED STATES OCEAN COLOR SENSORS. SNR_{spec} AND SNR ACTUAL
ARE AT $L_{in,spec}$. SNR MODEL IS ADJUSTED TO MODEL TOA RADIANCE FOR 10-mg/m³ CHLOROPHYLL *a* (SEE
FIG. 1). WAVELENGTH UNITS ARE nm AT THE NOMINAL BAND CENTERS, RADIANCE UNITS ARE Wm⁻²m⁻¹sr⁻¹

Band	Wavelength	$L_{in,spec}$	SNR _{spec}	SNR _{actual}	$L_{TOA\ model}$	SNR _{model}
CZCS						
1	443	54.10	150	260	40.60	211
2	520	35.00	140	260	23.34	180
3	550	28.60	125	233	20.23	208
4	670	13.40	100	143	9.79	112
SeaWiFS						
1	412	91.00	499	940	47.80	623
2	443	84.10	674	950	40.60	640
3	490	65.60	667	1156	29.89	651
4	510	54.40	640	1055	26.50	659
5	555	44.50	596	690	19.38	558
6	670	26.00	442	798	9.79	386
7	758	16.10	455	860	5.96	398
8	865	10.90	467	670	3.56	295
MODIS						
8	411	44.90	880	933	46.80	956
9	442	41.90	838	1325	40.60	1300
10	487	32.10	802	1308	29.89	1253
11	530	27.90	754	1385	22.70	1224
12	547	21.00	750	1114	19.38	1062
13	665	9.50	910	1163	9.91	1193
14	677	8.70	1087	1265	9.38	1323
15	746	10.20	586	1077	6.22	800
16	866	6.20	516	1000	3.56	717
3	466 (0.5 km)	35.30	243	316	36.44	328
4	553 (0.5 km)	29.00	228	302	19.38	240
1	644 (0.25 km)	21.80	128	168	10.06	114
2	855 (0.25 km)	24.70	201	414	3.56	132

For comparison, the specified SNR for various sensors have been computed for a common set of input radiance values given by the modeled spectra for TOA radiance as a standard. Table I provides the adjusted SNR and the model values (which are those plotted in Fig. 1 for high chlorophyll). The model uses an exact Rayleigh calculation with single aerosol scattering. The aerosol optical depth at 670 nm was 0.2, with an Angstrom exponent of 0.5, and 0.5-cm water and 0.35-cm ozone in the air column. The view is nadir with a solar zenith angle of 60°, and chlorophyll concentration was 10 mg m⁻³.

Performance of the CZCS at the model radiance levels was determined using preflight calibration and performance data plots provided by the manufacturer, Ball Aerospace Systems Division, Boulder, CO. Performance of SeaWiFS at model radiance values were interpolated from Table 26 in the SeaWiFS Prelaunch Sensor Acceptance Report [7], again based on measured performance test data. Values for SeaWiFS in column 4 of Table I are taken from Table 14 of Barnes *et al.* [8].

For MODIS, there remain slight differences between specified L_{in} and the model values (which arise again because of slight differences in viewing geometry and atmospheric conditions between this model and the analysis actually used to

set the SNR requirements). SNR's expected at model radiance values were estimated by using the following relationship:

$$SNR_{mod} = SNR_{spec} (L_{mod}/L_{spec})^{0.6} \quad (1)$$

where the subscripts refer to *model* value or *specification* value.

The adjusted SNR_{model} values given in Table I are plotted as a function of wavelength in Fig. 2, demonstrating improvement in SNR through the CZCS-SeaWiFS-MODIS progression, each increasing roughly by a factor of two. The requirement for very high SNR to quantify solar induced chlorophyll *a* fluorescence is apparent in the two MODIS bands near 670. Fig. 2 illustrates that several of the MODIS high-resolution bands slightly exceed CZCS performance at their higher resolution. This could prove useful in coastal and estuarine regions where higher spatial resolution can be used to avoid contamination by shorelines resolve generally smaller hydrodynamic turbulence scales than are found in the open ocean, although at-launch algorithms do not incorporate these bands. The equivalent SNR for these bands will increase as data are spatially averaged, and they will not saturate when viewing bright targets.

TABLE II
MODIS LEVEL 2 OCEAN PRODUCTS, SHOWING THE RELATIONSHIP TO MODIS PRODUCT IDENTIFICATION NUMBERS AND ATBD NUMBERS

Algorithm	Product Handbook ID	Product Handbook Name	Fields	ATBD	PI	Resolution
Atmospheric Correction	MOD-18	Water Leaving Radiance	Water Leaving Radiance, Atmos. Transmittance, Aerosol Optical Depths, Model Index, Epsilon Values	ATBD-MOD-17	Gordon	1km, DWM
	MOD-37	Ocean Aerosol Properties	Aerosol Optical Depths, Bands 8 - 16			
Empirical Algorithms	MOD-19	Pigment Concentrations	CZCS pigment, Total Pigment, Case 1 Chlorophyll <i>a</i>	ATBD-MOD-18	Clark	1km, DWM
	MOD-23	Suspended Solids	Suspended Solids Conc.			
	MOD-26	Diffuse Attenuation Coefficient	Diffuse Attenuation Coefficient (k_{490})			
Semi-analytic Algorithms	MOD-21	Chlorophyll <i>a</i>	MODIS Chlorophyll <i>a</i> (Case 1 & 2)	ATBD-MOD-19	Carder	1km, DWM
	MOD-36	Total absorption coefficient	$a_{tot}, a_{ph}, a_{tot}, A_{ph}$			
	MOD-24	Organic matter conc.	a_g			
PAR	MOD-22	IPAR	Instantaneous PAR, Abs. Rad. for Photosyn. (ARP)	ATBD-MOD-20	Carder	1km, DWM
Clear-water Epsilons	MOD-39	Epsilons	Epsilons	ATBD-MOD-21	Carder	1km, DWM
Coccolith	MOD-25	Coccoliths	Corrected Pigment, Coccolith conc., Calcite conc.	ATBD-MOD-23	Gordon (Baich)	1km, DWM
Phycobilipigments	MOD-31	Phycoerythrin	PEB, PUB	ATBD-MOD-27	Hoge	1km, DWM
Chlorophyll Fluorescence	MOD-20	Fluorescence	Fluorescence Line Height, Baseline	ATBD-MOD-22	Abbott	2 km, DWM
Primary Production	MOD-27	Primary Production	Weekly Prod. Index, Annual Total Production, Annual Export Production, Annual New Production	ATBD-MOD-24	Esaias	4.5 km, WMY
Sea Surface Temperature	MOD-28	SST	Skin and Bulk Temp, (Day, Night; 11- 12 μ , 4 μ)	ATBD-MOD-25	Brown	1km, DWM
Match-up Validation Data Base	MOD-32	Match-up Data	SST, Bio-optics	ATBD-MOD-26	Evans	5x5 1km arrays

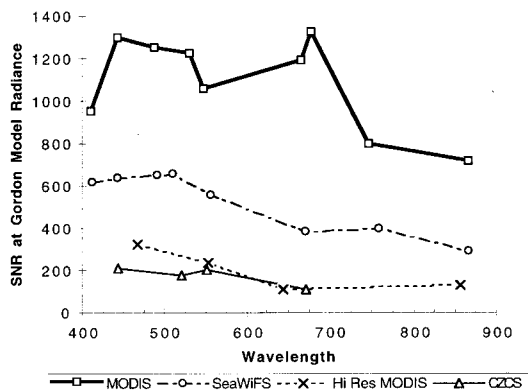

Fig. 2. SNR for CZCS, SeaWiFS, and MODIS, computed at a standard input radiance value, from Table I. SNR in four MODIS high-resolution bands (1–4) is also indicated. Values are plotted at band centers.

III. PRODUCT DESCRIPTIONS

The Level 2 ocean color products that will be derived from MODIS at launch are given in Table II. The algorithms that have been developed by science team members are described in Algorithm Theoretical Basis Documents (ATBD's), which are available through the EOS Project Science Office electronically at http://eospso.gsfc.nasa.gov/eospso_homepage.html. Summaries are also available in the EOS Data Products Handbook at the same location. Included here are brief synopses that emphasize the expected improvements with MODIS.

The data products will be available at Level 2 in 1000-km along-track granules and in several earth-gridded temporal and spatial resolutions. For Level 3, the standard gridded product is an equal-area sinusoidal grid, similar to the SeaWiFS grid,

but at 4.5-km spatial resolution. Standard mapped products at lower resolution are also enabled in software. A series of 1° resolution products is also envisioned.

For ease of discussion, the data products are produced in five basic groups— atmospherically corrected ocean reflectance group, a semianalytic bio-optical group, an empirical bio-optical algorithm group together with fluorescence and phycoerythrin, sea surface temperature, and ocean productivity (a Level 4 product in a sense because the inputs are Level 3 products). Table II shows these groups and cross-references to the EOS Data Products Handbook and ATBD designations. The relationship of the Level 2 ocean color products are shown in Fig. 3 and are discussed briefly here.

A. Atmospheric Correction

The portion of the radiance reflected from the ocean atmosphere system that was backscattered *out* of the water, and thus contains information about oceanic constituents, is at most 10% [55]. This maximal return occurs in the blue at very low concentrations of chlorophyll *a*. In the green, or for larger values of chlorophyll *a* in the blue, the ocean-penetrating fraction is considerably smaller. The rest of the reflected radiance seen by the sensor is scattered from the atmosphere and the sea surface. Retrieval of the relevant oceanic signal from the total radiance is termed atmospheric correction.

Atmospheric correction algorithms were developed for the CZCS by Gordon *et al.* [45], [50]–[53]. These were crude in the sense that multiple scattering in the atmosphere was ignored; however, sensors like MODIS are significantly better than CZCS in radiometric performance, and to take full advantage of the improved radiometry, more precise atmospheric

OCEAN COLOR LEVEL 2 DATA PRODUCTS

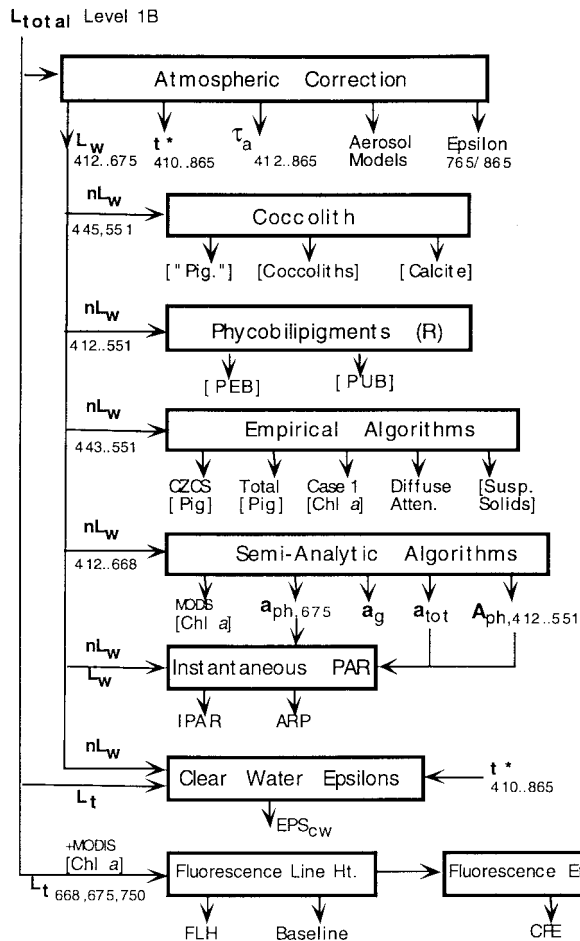

Fig. 3. MODIS Ocean Color Level 2 Simplified Algorithm Flow diagram. Geophysical products are at arrow terminations.

correction is required. Algorithms that achieve the required accuracy have been developed for SeaWiFS and MODIS, and a comprehensive review of the present state of atmospheric correction is provided by Gordon [47]. We provide a brief description of the MODIS atmospheric correction algorithm next.

As it is now possible to calibrate sensors directly, with respect to the sun, it is preferable to use the generalized reflectance rather than the radiance. The reflectance ρ is related to the radiance L through $\rho = (\pi L/F_0) \cos \theta_0$, where F_0 is the extraterrestrial solar irradiance and θ_0 is the solar zenith angle. The TOA reflectance ρ_t is given by

$$\rho_t = \rho_r + \rho_a + \rho_{ra} + t\rho_w + t\rho_{wc} + T\rho_g \quad (2)$$

where the subscripts r , a , ra , w , wc , and g , refer, respectively, to the contribution to the reflectance from Rayleigh scattering in the absence of aerosols, the contribution of aerosol scattering in the absence of air molecules, the contribution from interactions involving both molecular and aerosol scattering, the contribution from photons backscattered *out* of the water (the desired *water-leaving reflectance*), the contribution from whitecaps on the sea surface, and the contribution from photons specularly reflected from the sea surface without ever

interacting with the atmosphere (sun glint). In this equation, t is the diffuse transmittance of the atmosphere and T is the direct transmittance. The contribution from sun glint can be very large near the specular image of the sun (where the sensor would be viewing the image of the sun reflected from a *flat* sea surface), but falls rapidly away from this point. The water-leaving signal in this region cannot be retrieved accurately, and the data there must be discarded. Thus, we ignore the contribution of ρ_g by virtue of discarding the imagery where it is significant. The zone for which data cannot be processed is delineated by an estimate of the wind speed (from numerical weather assimilation models) along with the Cox and Munk [34] model of the sea surface [47]. The whitecap contribution is small and can also be estimated from an estimate of the wind speed [44], [56]. The Rayleigh scattering contribution can be precisely computed given the surface atmospheric pressure [48], which is also estimated from numerical weather models. Derivation of ρ_w from ρ_t still requires estimating $\rho_A \equiv \rho_a + \rho_{ra}$. This is the most difficult aspect of the atmospheric correction problem because at the level of accuracy required for modern sensors, multiple scattering affects cannot be neglected. It is even more complex because simulations [45], [47] show that the influence of multiple scattering is dependent on the physical-chemical properties of the aerosol as well as on its concentration. Thus, in order to evaluate the amount of multiple scattering, a model for the aerosol properties must be assumed or determined from ρ_t . Fortunately, in Case 1 waters, i.e., waters for which phytoplankton and their immediate decay products control the optical properties of the water [55], $\rho_w \approx 0$ in the NIR. MODIS has two spectral bands in the NIR that possess this property: 748 and 869 nm (bands 15 and 16). Thus, for these bands, it is possible to estimate ρ_A at each pixel in Case 1 waters. The spectral variation of ρ_A between these two wavelengths can then be used to select an aerosol model (actually two) from a list of possible candidates. Presently, the candidate aerosol models that are used in the MODIS atmospheric correction algorithm are those provided by Shettle and Fenn [100]. The chosen candidate aerosol models are then used to extrapolate ρ_A into the visible. This extrapolation is effected through a set of lookup tables (LUT's) that provide ρ_A as a function of the aerosol concentration for all sun-viewing geometry's. The LUT's are computed for each candidate aerosol model using a two-layer radiative transfer code, with all of the aerosol scattering in the lower layer and the Rayleigh scattering in the upper layer.

The atmospheric correction algorithm described above has been shown to be capable of retrieving the water-leaving reflectance with the required accuracy under most oceanic conditions. However, problems are encountered when the aerosol is strongly absorbing, e.g., urban pollution or desert dust transported over the oceans by the winds. The difficulty with absorbing aerosols is twofold [47]. First, the spectral variation of ρ_A in the NIR is for the most part determined by the size distribution of the aerosol and is very weakly dependent on its composition; therefore, weakly and strongly absorbing aerosols with similar size distributions cannot be differentiated. Second, in contrast to weakly absorbing aerosols,

the influence of strongly absorbing aerosols on ρ_A shows a significant dependence on their vertical distribution. Recently, Gordon *et al.* [54] have proposed an algorithm that shows considerable promise in dealing with both weakly and strongly absorbing aerosols in Case 1 waters. The basic idea is that, because the effects of strong absorption on ρ_A are manifest in the blue portion of the spectrum, where there is significant multiple scattering due to the large Rayleigh optical thickness, even at small aerosol concentrations, it is necessary to do atmospheric correction and retrieve the bio-optical parameters simultaneously. Briefly, $\rho_A(\lambda)$ is computed for each candidate atmospheric model as a function of aerosol concentration. Similarly, $\rho_w(\lambda)$ is computed as a function of the ocean's constituent concentrations (chlorophyll *a*) using a bio-optical model [48]. All of the parameters (aerosol model and concentration and ocean constituent concentrations) are then systematically varied until the differences between the observed and modeled $\rho_a(\lambda) + t(\lambda)\rho_w(\lambda)$ reach a minimum in an rms sense. This minimum provides the desired atmospheric and oceanic parameters. This algorithm is presently undergoing extensive testing. It can be expected to run much slower than the at-launch version; however, the strategy will be to utilize it at reduced resolution for the purpose of assessing the probability of having absorbing aerosols and finding an appropriate set of aerosol models.

B. Empirical Algorithms

Phytoplankton biomass is usually expressed in terms of chlorophyll *a* concentration because of the ease of making these measurements and because all photoautotrophs contain chlorophyll *a* in the primary reaction centers. It remains the primary derived product used by biological oceanographers. The empirical algorithms are based on relationships between *in-situ* optical measurements of remote-sensing reflectance or normalized water-leaving radiance (nL_w) and simultaneous property concentration measurements. To account for optical signal attenuation, the *in-situ* concentrations are weighted according to the diffuse attenuation coefficient [50]. These relationships are then applied using satellite-derived nL_w and compared with simultaneous chlorophyll data collected at the time of satellite overpass. *In situ* measurements are made according to established protocols [89].

Initial CZCS results reported by Gordon *et al.* [51] demonstrated an excellent potential for achieving the CZCS goal of measuring phytoplankton pigment concentrations to within about a factor of two. The pigment retrievals, when compared to the shipboard measurements, yielded an agreement to better than 0.5 in $\log_{10} C$, where C is the sum of the chlorophyll *a* and phaeopigment *a* pigments in mg m^{-3} . In general, within their comparison, there appears to be a trend toward under estimating the pigment concentration with the CZCS algorithms. A source for this underestimation lies within the preliminary pigment algorithm itself. This bias was corrected

TABLE III
PRELIMINARY AT-LAUNCH VALUES OF COEFFICIENTS FOR (3) AND (4)

Product	A	B	C	D	E	e	f	g
log(Pigment)CZCS	0	0	-1.27	0.5	1	1	0	0
log(Pigment)SeaWiFS	-4.54	10.32	-9.74	3.00	1	1	1	1
log(Chl <i>a</i>)	-4.99	12.34	-12.12	3.78	1	1	1	1
log(Diffuse Attn)	0	0	-1.4	0.07	1	1	0	0

by recasting the preliminary pigment algorithms with the addition of data from postlaunch validation cruises into forms that are specific to this remote-sensing application and the CZCS spectral characteristics. The purpose of implementing these modifications was twofold: to reduce the sources for systematic bias in estimating the pigment concentrations and to provide a computation that incorporates the depth dependence of the optical signal and the variations in the vertical distribution of phytoplankton. Phytoplankton pigment algorithms, for example, require an accurate determination of water-leaving spectral radiance. Actually, only the spectral character needs to be retrieved accurately, since within this algorithm scheme, only radiance ratios at different wavelengths are used, resulting in some reduction of errors.

The basic form that satisfies the MODIS bio-optical at-launch empirical products is

$$\log \text{Product} = A(\log X)^3 + B(\log X)^2 + C(\log X) + D/E \quad (3)$$

where A, B, C, D , and E are least-squares regression coefficients or constants and here the constants e, f , and g are zero or one and used to select the spectral bands employed to derive the specific product. The preliminary coefficients (Table III) are based on the original CZCS experimental database adjusted for the SeaWiFS bandwidths. These coefficients will be revised prior to launch for the MODIS spectral band characteristics and use of the new *in-situ* bio-optical database. This form accommodates up to four principle wavelength bands that are employed in the empirical derivation of bio-optical products in either single or multiple wavelength ratios. It will be used to generate the following at-launch products for Case 1 waters: CZCS Pigments (chlorophyll *a* plus phaeopigments), chlorophyll *a* (Case 1), Diffuse Attenuation Coefficient (k 490 nm), and suspended solids.

Recent comparisons by O'Reilly and Maritorena [92] between pairs of *in-situ* optical and pigment concentration resulted in a third-order polynomial relating chlorophyll *a* and the ratio of SeaWiFS bands 3 and 5 with very small apparent error or bias. This relationship is presently used for SeaWiFS and can be easily accommodated using MODIS bands 11 and 12 in (3) and (4), respectively. [Equation (4) is shown at the bottom of the page.] It will be considered for MODIS following validation of SeaWiFS data products.

$$X = \frac{(e)nLw(\text{band}9, 443) + (f)nLw(\text{band}10, 490) + (g)nLw(\text{band}11, 531)}{nLw(\text{band}12, 550)} \quad (4)$$

C. Coccoliths and Calcite

Coccoliths are small calcite (CaCO_3) plates produced by a distinct taxon of marine phytoplankton, the coccolithophores, which are cosmopolitan in the oceans. Several species, notably, *Emiliana huxleyi*, form dense blooms in temperate and subarctic waters [18] that are highly visible due to increased optical scatter from the coccoliths. Coccoliths are continually produced on the surface of the flagellated algal cell and become detached with time. During the latter phases of blooms, the free coccoliths greatly exceed those attached. The coccoliths serve as very efficient, white, optical scatterers. Because of the anomalous light absorption-to-scattering ratio in these blooms, basic assumptions for atmospheric and bio-optical algorithms are violated and the chlorophyll *a* retrievals can be heavily impacted [49]. These organisms play a unique role in the ocean carbon biogeochemical cycle since large amounts of calcite are exported to the deep ocean during such blooms [67]. Additionally, this species is a primary source of oceanic dimethyl sulfide, with implications on cloud formation and coverage [25]. They also provide opportunity to study the population dynamics of a single plant species with remote sensing, which is rare in both the terrestrial and marine biospheres. For these reasons, it is important to correct the chlorophyll algorithms for their presence as well as derive their abundance and calcite concentration.

The MODIS coccolith products are derived using a semianalytic approach in conjunction with the atmospheric correction process. LUT's relating anomalous spectral scattering to the coccolith concentration, and to the calcite concentration, are used to retrieve a more accurate chlorophyll product within the blooms as well. This approach differs from the SeaWiFS at-launch coccolith algorithm [17], which is used to classify blooms and compute their area, but which does not provide concentration values. The MODIS algorithm will undergo extensive testing using both SeaWiFS data and with a substantial collection of *in situ* optical backscatter, calcite, and coccolith determinations made over the past several years in the Atlantic [5], [6] and Indian oceans. An extensive shipboard algorithm validation effort is already underway using SeaWiFS observations. For MODIS, it is expected that several of the ocean bands may show saturation at high-coccolith concentrations, where surface reflectance can exceed 25%. Under those conditions, the use of MODIS bands 1–4 can be substituted.

D. Semianalytic Bio-Optical Algorithms

The semianalytical, bio-optical model of remote-sensing reflectance (e.g., normalized water-leaving radiance) developed by Lee *et al.* [75] provides the basis for the MODIS algorithm for the concentration of chlorophyll *a* as well as for calculations of absorbed radiation by phytoplankton (ARP). The latter quantity is utilized by the MODIS chlorophyll fluorescence algorithm (see below) to form a parameter indicative of the physiological state of phytoplankton, the quantum yield of fluorescence.

The algorithm is developed such that four quantities are determined: chlorophyll *a*, absorption by gelbstoff (dissolved

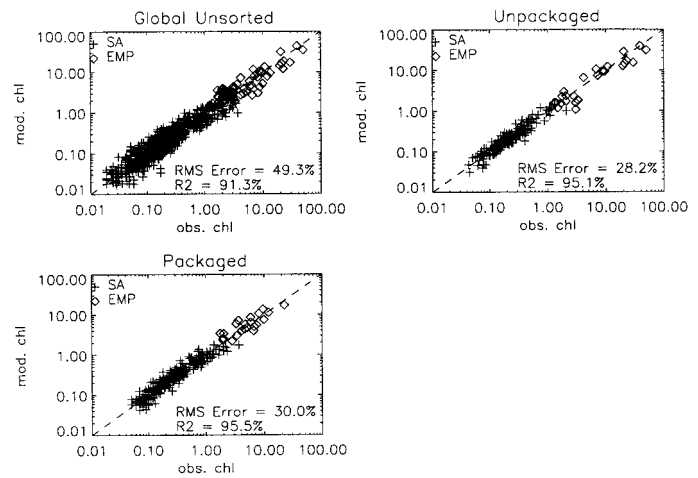

Fig. 4. Performance of the combined empirical (diamonds) and semianalytic (plus signs) chlorophyll algorithms for global *in-situ* observations, predicted using the MODIS algorithm from shipboard optical observations (Global Unsorted) and regions where phytoplankton “packaging” effects are important (Packaged) and negligible (Unpackaged). Rms difference is given in terms of log chlorophyll.

blue absorbing organic matter) at 400 nm, absorption coefficient of phytoplankton (expressed at 675 nm), and ARP. With these variables, the total absorption coefficients for the visible region can be deduced through use of algorithm parameters. ARP also depends upon the instantaneous flux of photons per wavelength interval just beneath the sea surface [60], which is calculated as part of the instantaneous photosynthetically available radiation (IPAR) algorithm [23]. ARP is an expression of the quanta absorbed by phytoplankton in the top 3 m of the water column, the interval from which more than 90% of the upwelling fluorescence photons that are seen by the sensor originate.

A unique aspect of the MODIS chlorophyll *a* algorithm is that it is not based on a simple regression equation using the global database. It is instead physically based for the optical portions of the algorithm and empirically based for the bio-optical portions. The bio-optical parameters, however, change with the dominant species assemblage on a seasonal and geographic basis, driven by changes in nutrient and light availability and temperature, and various bio-optical domains are deduced empirically using MODIS sea-surface temperature data, as compared to the Kamykowski [71] nitrogen-depletion temperatures for a given location [22]. This relationship between nutrients and temperature results from the deep-mixing or upwelling of cool, nutrient-rich waters found beneath the surface-mixed layer, as reflected in the historic nutrient-temperature database of the NOAA National Oceanographic Data Center, Silver Spring, MD.

Identification of bio-optical domains improves chlorophyll *a* retrievals from about $\pm 50\%$ uncertainty to less than $\pm 30\%$ uncertainty (see Fig. 4). Also, since the spectral absorption coefficient of seawater can be determined by summing the absorption components of gelbstoff, phytoplankton, and water, it is possible with MODIS data to calculate the depth of penetration of light into the upper ocean and the resulting vertical distribution of heat due to insolation.

E. Clear-Water Epsilons

Since atmospheric radiance can be ten times that of water-leaving radiance, aerosol radiance must be accurately deduced for ocean-color algorithms for chlorophyll *a* to be at all accurate. Estimates of the aerosol radiance received by MODIS over the ocean depend upon spectral extrapolation of the behavior of aerosol backscattering based upon measurements in the infrared where the ocean is “black.” Marine aerosols are largely nonabsorptive and predominate over the ocean most of the time. Occasionally, red iron-rich dust from the Sahara and Gobi deserts, for example, are carried across the north Atlantic and Pacific basins, and they absorb significantly at blue wavelengths, as do phytoplankton.

The clear-water epsilon algorithm is designed to flag blue-absorbing aerosols based upon our *a priori* knowledge of the water-leaving radiance at 532, 551, and 667 nm, which are stable for waters with chlorophyll *a* values less than about 0.4 mg/m³ (hence, “clear water”). The epsilon values are based upon spectral ratios of aerosol reflectance values [e.g., $\rho_a(531)/\rho_a(667)$] [53].

Flagging for data points with epsilon values less than about 0.95 provides an indication of absorption at the blue end of the spectrum and is indicative of iron-rich aerosols. These flagged pixels must be corrected with a nonstandard algorithm during a reprocessing phase. Iron can be a limiting nutrient in the open ocean. A research objective is to spectrally quantify the fraction of iron present in terrigenous aerosols.

F. Phycoerythrin

There are three major algal pigment groups found in marine phytoplankton and bacteria: the chlorophylls, carotenoids, and phycobilins [13]. The major phycobilins are phycoerythrin (PE) and phycocyanin. The PE's are a class of pigment-protein macromolecules with chromophores that absorb light in the ~480–580 spectral region. These chromophores are of two types: phycoerythrobilin (PEB), which absorbs in the 565-nm region, and phycourobilin (PUB), which absorbs in the 495-nm region. PEB is a component of the photosynthetic light harvesting system and is found in all PE-containing marine cyanobacteria. The PE spectral absorption band peaks near 565 nm when only PEB chromophores are present and 10–15 nm lower when PUB chromophores are present.

PEB has been observed by active (laser) airborne fluorescence methods since 1979 [63] and recognized in upwelled radiance values since 1986 [64], [65]. Phycoerythrin fluorescence was detected as an increase in the 560–600-nm region of surface upwelling irradiance spectra in Lake Washington [32].

The PEB concentration is derived as a research product by numerical radiance model inversion of nL_w . Previous oceanic radiance model inversion theory described retrieval of three inherent optical properties (IOP's): total backscatter, absorption coefficient of chromophoric dissolved organic matter (CDOM), and the absorption coefficient of phytoplankton [66]. The radiance model inversion theory has been extended to accommodate absorption at ~565 nm due only to PEB pigment, absorption of PEB at ~545 nm (when PUB substitution occurs at some selected PE chromophore sites), and

PUB absorption at ~495 nm. The PEB absorption coefficient retrieval will be validated by comparison with airborne laser-induced PEB fluorescence and published laboratory values of PEB absorption coefficients.

PE retrieval is an important research product that will enable scientific investigation of the global distribution of the PE pigment and the diversity of PE-bearing species, especially cyanobacteria. The PE-containing organism *Trichodesmium* is the major ocean nitrogen fixer. Since fixed nitrogen commonly limits phytoplankton production in the ocean, oceanic nitrogen fixation has direct links to the ocean carbon cycle [72], [41]. At times, oceanic carbon production by cyanobacteria is greater than that of the larger phytoplankton.

G. Ocean Primary Production

For ocean applications, primary productivity is the net rate of carbon fixation by phytoplankton through the process of photosynthesis, as measured by the radiocarbon uptake technique using water samples incubated either at the depth from which they were collected or in simulation incubators. Units of production are gm Carbon m⁻² day⁻¹. Rates estimated for weekly and annual time periods simply equal the summation of the daily rates, or integration using trapezoidal interpolation. Ocean primary production rates reflect the fact that phytoplankton biomass, as estimated by chlorophyll concentration, can experience up to several doublings per day.

Of interest to global biogeochemical cycle studies is the amount of organic carbon that sinks from the sunlit zone through the upper mixed layer to enter the deep ocean, where the CO₂ resulting from its decomposition is removed from direct contact with the atmosphere for extended periods. This portion of net production is called export production. Primary production can also be differentiated according to whether the phytoplankton use nitrogen that originates from recycling within the upper mixed layer grazing population (recycled production) or, conversely, whether the nitrogen is “new” to the mixed layer as a result of upwelling or seasonal mixing (new production). New production is typically reported in nitrogen units because it is approximated by the uptake of nitrogen in the form of nitrate, which results from fully oxidized organic matter [34].

The major variable determining marine primary production for any given day is the biomass of phytoplankton, which itself results from previous production. Light spectral intensity as a function of depth, nutrient availability, temperature, and other factors, such as intensity of mixing, advection, and zooplankton grazing are also quite important.

The MODIS Primary Production Product (Fig. 6) provides two estimates, or indexes, of short-term net carbon production and separate estimates, on annual scales, of net carbon production, export carbon production, and new nitrogen production, using empirical annual algorithms.

The two short-term index calculations are performed using weekly (eight-day) averaged chlorophyll concentration and produce estimates of total carbon production for the global ocean region. The first index, developed by Behrenfeld and Falkowski [12], estimates daily production in the euphotic

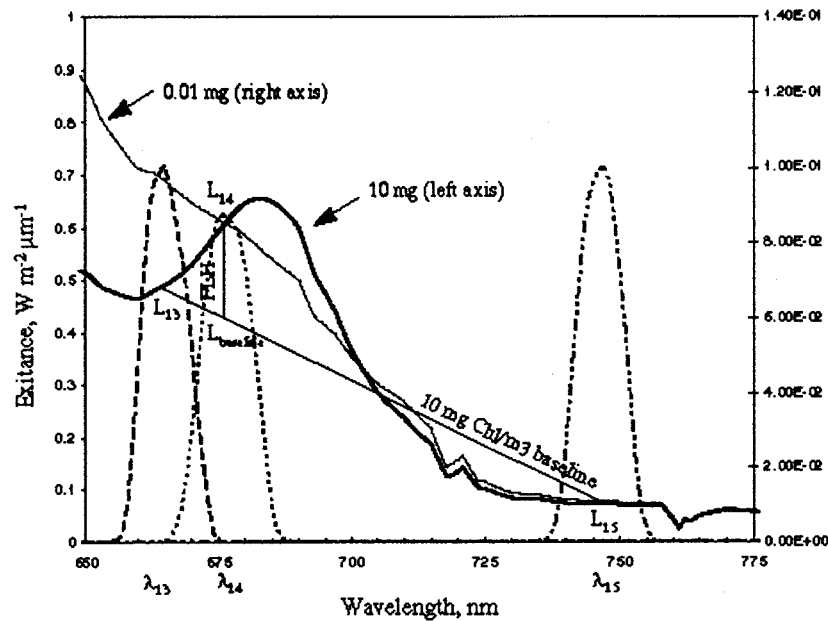

Fig. 5. Illustration of the approach for determining the baseline and FLH at 678 nm, using bands 13–15.

zone as a function of surface chlorophyll a , daily integrated PAR, day length, and the maximal rate of carbon production per unit chlorophyll a , as a function of depth within the euphotic zone ($P_{b,opt}$). When $P_{b,opt}$ is plotted against temperature for a wide range of global and seasonal *in-situ* data, a strong relationship is apparent. Therefore, its local value is parameterized as function of SST. The euphotic zone is the depth interval from the surface over which 99% of sunlight is attenuated and calculated from MODIS products.

The second short-term index, developed by Howard and Yoder [68], uses a similar approach, but requires an independent estimate of the physical upper mixed layer depth, rather than the euphotic depth, for integration. The mixed layer depth, as determined by the Navy's OTIS numerical ocean assimilation model, is used for this variable. A second difference is that the maximum rate of production per unit chlorophyll a , as a function of light intensity (P_{max}), is used as the light utilization efficiency factor instead of $P_{b,opt}$. P_{max} is parameterized as function of SST, different from that used for $P_{b,opt}$. The shortwave incident radiation field available from the Data Assimilation Office, Goddard Space Flight Center, Greenbelt, MD, is used to estimate daily integrated incident PAR for both products.

The two approaches produce different distributions on short time scales, but which appear to converge (to within 30%) when integrated globally over the year [12], [67], [68] and with other estimates based on models [96] and satellite data, as discussed in [41], [79], and [96]. Development of a consensus algorithm is the focus of NASA's Primary Productivity Working Group (NPPWG) [41]. It is expected that intensive applications using SeaWiFS data and early MODIS data will improve convergence and be useful in assessing the overall uncertainty and errors between these and other different approaches within various oceanographic regimes. The approach described here for the evolution of this product is in keeping with the science strategy issued by the NPPWG [41].

The annual primary production estimate is based on simple linear relationships between annual production terms and chlorophyll a , averaged over a year developed by Iverson *et al.* [69]. These relationships hold for those portions of the open ocean that show high-annual variance in Level-3 chlorophyll concentration (HV regions). Annual carbon production, export production, and new production are computed at weekly intervals using a running annual (46 eight-day week) average. The linear relationships explains 98% of the variance in the production-chlorophyll plots for the high-variance areas. These areas occupy about 28% of the global ocean based on the CZCS analysis. The HV areas account for about 70% of the global export production and new production components, but only about 30% of total carbon production [69]. On annual scales, there is no simple linear relation between average chlorophyll and production terms in the low-annual chlorophyll variance portion of the ocean.

H. Solar-Stimulated Chlorophyll Fluorescence

Light energy absorbed by phytoplankton chlorophyll has one of three fates. Most (more than 90%) is lost at heat. Some (up to 12%) can be converted to chemical energy via the process of photosynthesis. Another small and variable fraction (up to 3%) is reemitted as fluorescence. Solar-stimulated chlorophyll fluorescence appears as a distinct peak centered at 683 nm in the upwelling radiance spectrum in natural waters (Fig. 1). This peak produces a positive deviation from the expected sea-surface-leaving radiance of pure water and has been studied by numerous researchers using *in situ* as well as remote-sensing devices mounted in aircraft [43], [46], [58], [74], [91].

As a result of studies of sun-stimulated fluorescence, satellite sensors capable of measuring chlorophyll fluorescence from low earth orbits are being developed, the first of which is MODIS. Using narrow bands centered at 665.1, 676.7, and 746.3 nm (Fig. 5), this sensor will be able to detect chlorophyll

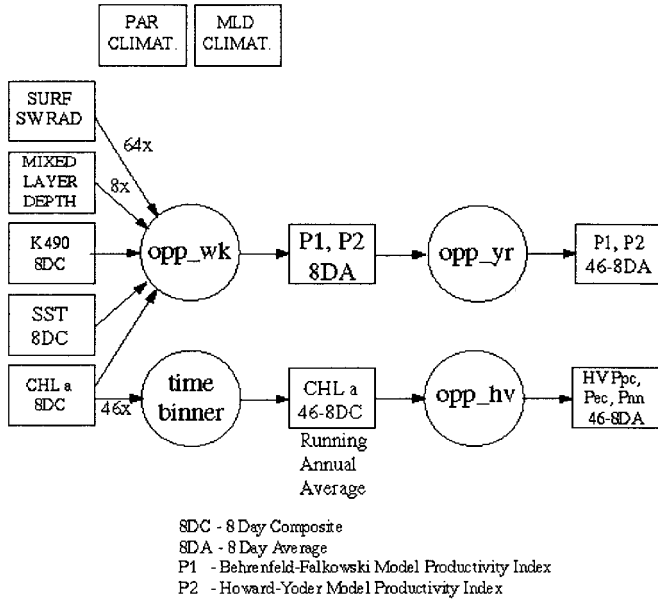

Fig. 6. Ocean Primary Productivity Algorithm Flow Diagram, illustrating the short-term Productivity Index and Annual HV pathways.

fluorescence signals at 676.7 nm (fluorescence line height or FLH) as low as $0.012 \text{ Wm}^{-2}\text{sr}^{-1}\text{mm}^{-1}$ [76].

By dividing the FLH by the rate of energy absorbed by the photosynthetic systems (absorbed radiation by phytoplankton; MODIS-21 product) it will be possible to estimate a chlorophyll fluorescence efficiency (CFE) that is proportional to the fluorescence quantum efficiency.

In recent years, research has been focused in the use of sun-stimulated fluorescence to estimate photosynthetic rates [26], [27], [73]. Based on Butler's tripartite model of the photochemical apparatus [19], we should expect to observe that the quantum efficiency of fluorescence varies inversely to the quantum efficiency of photosynthesis because both processes are competing for energy during the de-excitation of chlorophyll. However, the relation is not simple and may not work over a wide range of oceanic conditions, considering that the de-excitation of chlorophyll resulting in heat dissipation is the major dissipation pathway [40].

Semiempirical algorithms used to estimate primary productivity (PP) from remote-sensing platforms are based on our the ability to monitor remotely available irradiance (E) and chlorophyll concentration [chl] in the surface of the ocean. However, in order to obtain an accurate estimate of photosynthetic rates, we also need to know the amount of available energy being absorbed by the photosystem (the product of E , [chl], and the specific absorption coefficient a^*) and the fraction of absorbed energy being stored in organic matter. This fraction is also known as the photosynthetic quantum efficiency (Φ_p). Neglecting spectral effects for illustrative purposes, on a unit volume basis, is indicated by

$$PP = E[chl]a^*\Phi_p. \quad (5)$$

The remote-sensing estimation of [chl] in surface waters is derived from the reflectance or upwelling radiance ratio between wavelengths within the main absorption band of

phytoplankton pigments and wavelengths outside this band [28]. Consequently, this estimation is derived from the rate of light absorption by algae and corresponds to the product of E , [chl], and a^* [77]. In the case of fluorescence, a similar simple equation for fluorescence emission, again ignoring spectral effects for the sake of simplicity, is

$$F = E[chl]a^*\Phi_f \quad (6)$$

where Φ_f is the quantum efficiency for fluorescence.

Although developing relationships between Φ_f , CFE, and photosynthetic quantum efficiency (Φ_p) will not be straightforward, recent *in situ* studies suggest that variations in CFE may prove useful as indicators of changes in the nutritional status of phytoplankton [77]. Furthermore, spatial and temporal studies addressing the variability of CFE may also help us to better understand and predict the variability in Φ_p [1]. Knowledge of the scales of variability of Φ_p will allow a better estimation of some of the errors associated with the calculation of PP using semiempirical algorithms, especially the errors associated with variations in P_{max} or $P_{b,opt}$ and a^* .

I. Sea Surface Temperature

1) *Precursor Instruments in the Infrared Region:* MODIS builds on the experience of the NOAA AVHRR [96], [97] and the ERS Along Track Scanning Radiometer (ATSR) [35], [85]–[87] missions. Bands used in SST determination for MODIS and other missions of interest are shown in Table IV. These particular bands were chosen for MODIS based on specific aspects of the atmospheric total column transmissivity in each part of the mid- and far-infrared spectrum. Fig. 7 presents a profile of the expected earth radiance at satellite height from 3 to 14 μm . AVHRR experience suggested improvement of blackbody design and lowering of NEDT's for the sensor would lead to direct improvements in the accuracy of retrieved temperatures. Such improvements were included in the ATSR design, and on-orbit performance manifested desired increases in SST retrieval accuracy. ATSR posited validation of the "skin" temperature rather than the "bulk" temperature, as in AVHRR, i.e., validation of the actual sensed parameter in lieu of a surrogate. Preliminary results from ATSR [90], [99] suggest that such is feasible and does add information of geophysical importance.

2) *Design Innovations in the Infrared Bands:* MODIS incorporates a split-window in the 4- μm window with high-performance detectors (see Table V). Addition of this split-window is expected to markedly improve nighttime surface temperature estimates in tropical and subtropical regimes, as both channels are transmissive enough to see through maximum column water vapor loads (Fig. 7). Addition of bands in the near-infrared (see [9]) permits improvement of cirrus cloud detection and should also provide aerosol detection and absorption estimates. The presence of aerosols, both tropospheric and stratospheric, can introduce unacceptable errors in surface temperature retrievals of $>1 \text{ K}$ [39], [88]. Unless the aerosol layer is sufficiently dense for it to be identified by the cloud screening algorithms, the aerosol effects cannot be easily identified in current

TABLE IV
BAND CHARACTERISTICS OF SATELLITE-BORNE INFRARED RADIOMETERS

NO.	MODIS ¹		AVHRR ²		ATSR ³		OCTS ⁴		GLI ⁵	
	λ (μm)	NE Δ T (K)	λ (μm)	NE Δ T (K)	λ (μm)	NE Δ T (K)	λ (μm)	NE Δ T (K)	λ (μm)	NE Δ T (K)
20	3.78	0.028	3.75	0.1 2	3.7	0.019	3.7	0.15	3.715	<0.15
22	3.97	0.028								
23	4.056	0.026								
29	8.518	0.012					8.52	0.15	8.3	<0.1
31	11.017	0.024	10.5	0.1 2	10.8	0.028	10.8	0.15	10.8	<0.1
32	12.032	0.04	11.5	0.1 2	12.	0.025	11.9	0.15	12	<0.1

¹ For Proto-Flight Model., From [9].

² For a target temperature of 300K. From Planet, 1988.

³ Derived from 500 samples of black-body measurement at a temperature of 298K. [From Minnett, 1995b].

⁴ For a target temperature of 300K. From OCTS instrument description.

⁵ From NASDA Research Announcement, October 24, 1995.

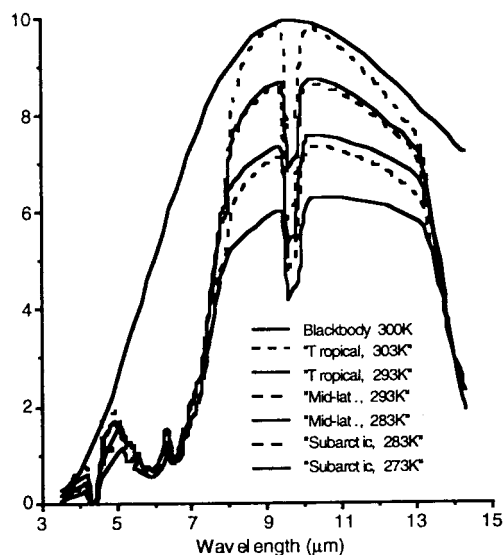

Fig. 7. Earth radiance in the mid- to far-infrared spectrum. The various curves give a range of expected infrared radiances for a variety of typical atmospheres and surface temperatures. A 300-K blackbody curve is provided to permit visual comparison of the path length absorption for the various cases. Profile data are computed by the Lowtran radiative transfer program [107].

satellite data themselves. However, MODIS offers for the first time collocated VIS-NIR measurements, in which aerosol signatures can be more readily identified, with the infrared bands used for SST measurements. Thus, the combination of infrared data and visible aerosol estimates provided by a single instrument, which has been impractical on previous instruments, will be straightforward on MODIS.

3) *On-Orbit Characterization of the Infrared Bands:* The state-of-the-art "Denton" coated scan mirror utilized in MODIS to minimize polarization effects in the visible has notable changes in emissivity over the infrared spectral range of the instrument. Characterization of this emissivity to desired levels of accuracy is impractical on earth. The GOES 8 and 9 imagers use similar technology and have developed an

TABLE V
BANDS FOR MODIS INFRARED SST DETERMINATIONS

Band Number	Band Center (μ)	Bandwidth (μ)	NE Δ T (K)
20	3.785	0.1877	0.0275
22	3.970	0.0876	0.0277
23	4.056	0.0867	0.0255
31	11.0172	0.537	0.0244
32	12.0324	0.525	0.0402

on-orbit approach to characterizing mirror emissivity, which is based on deep-space scans [104]. This will also be the approach for determination of MODIS scan mirror infrared emissivity variations.

4) *Algorithm Description:* Given well-calibrated radiance's from MODIS, deriving accurate sea surface temperature fields and associated statistics is dependent on the ability to correct for the effects of the intervening atmosphere on these spectral radiance's and to provide assimilation mechanisms that cover the time-space windows of interest. Sensing SST through the atmosphere in the thermal infrared is subject to several environmental factors that degrade the accuracy of the perceived temperature. Major sources of error in the radiometric determination include the following:

- 1) sun glint (MODIS channels 20, 22, and 23);
- 2) water vapor absorption in the atmosphere (primarily MODIS channels 31, 32);
- 3) trace gas absorption (all channels); and
- 4) episodic variations in aerosol absorption due to volcanic eruptions, terrigenous dust blown out to sea, etc. (all channels).

Although satellite radiometers sense the ocean's radiation temperature known as "skin" temperature, satellite results are commonly compared with bulk temperature measurements in the upper several meters of the ocean. Air-sea interaction modifies the relationship between these two variables and causes

observable differences in the bulk and radiation temperatures [30], [93], [97]. We must be prepared to quantify regional and temporal differences between bulk and skin temperatures. This is one of the goals of the *in situ* SST calibration and validation activity.

The integrated atmospheric transmissivity over each of the MODIS infrared channels (20, 22, 23, 31, and 32) differs. Consequently, algorithms can be constructed that depend on the differences in measured temperature among these channels [3]. The simplest such algorithm assumes that, for small cumulative amounts of water vapor, the atmosphere is sufficiently optically thin that the difference between the measured temperature in any channel and the true surface temperature can be parametrized as a simple function of the difference between the measured temperatures in two channels with different atmospheric transmissions.

We are using the line-by-line numerical radiative transfer code developed at Rutherford Appleton Laboratory, Rutherford, U.K., as a basis for modeling atmospheric absorption processes in the MODIS infrared bands [78], [106]. Linear algorithms (MCSST) are based on a formula of the following form for the surface temperature T_s :

$$T_s = \alpha + \beta T_i + \gamma(T_i - T_j) \quad (7)$$

where the $T_{i,j}$'s are brightness temperatures in various channels for a given location and the coefficients α , β , and γ give the parameterized correction [33], [78], or can be derived empirically from good composite sets of surface and satellite observations [82]–[84], [93]. In (7), such an algorithm constructed on channels 31 and 32 would replace i, j by 31 and 32, respectively. Although (7) is easy to implement, it does not permit correction for changes in air mass due to scan-angle. Llewellyn-Jones *et al.* [78] developed a table from numerical simulations that permits modification of (7) into a form

$$T_s = \alpha'(\theta) + \beta'(\theta)T_i + \gamma'(\theta)(T_i - T_j) \quad (8)$$

where θ is the zenith angle. This approach reduces the errors at large scan angles for moist atmospheres by more than 1 K. Somewhat more complex algorithms have evolved to take into account nonlinearities in the radiative transfer and changing path length effects across the swath of an imaging radiometer. The currently operational atmospheric correction algorithm is the Non-Linear SST (NLSST) equation [102], [103]

$$\text{SST} = \alpha + \beta T_i + \gamma(T_i - T_j) \cdot T_s + \xi(T_i - T_j) \cdot (s^{-1}) \quad (9)$$

where T_s is an *a priori* estimate of the SST, which is used to scale the atmospheric correction for different environmental regimes, and θ is the satellite zenith angle.

For MODIS SST estimation (proto-algorithm), we will eventually implement a correction equation that is a variation of (9) for multiple pairs of the available bands. This will be coupled with an objective criterion based on observed

TABLE VI

TABLE OF LEVEL 3 PRODUCT FILES. FILES CONTAIN THE SUM, SUM SQUARED, NUMBERS OF OBSERVATIONS, AND PIXEL LEVEL QUALITY ASSESSMENT INFORMATION, AND WILL BE FOR DAILY, EIGHT-DAY, MONTHLY, AND ANNUAL TIME PERIODS AT 4.2×4.2 km AND $1 \times 1^\circ$ SPATIAL RESOLUTION. ESDT IS THE EARTH SCIENCE DATA TYPE USED BY THE GODDARD DAAC

ESDT	MODIS Prod ID	Field Description
MODOCX01-07	MOD 18	nLw, 412..678
08	MOD 37	Tau aerosol,865
09	MOD 37	epsilon (765/865)
10-11	MOD 37	Aerosol model ID 1,2
12	MOD 39	epsilon for clear water, 531
13	MOD 19	CZCS Pigment
14	MOD 19	Chlorophyll MODIS
15	MOD 19	Total pigment - case 1
16	MOD 20	Fluorescence Line Height
17	MOD 20	Fluorescence Baseline
18	MOD 20	Fluorescence Efficiency
19	MOD 23	Suspended Solids Concentration
20	MOD 25	Pigment conc. in coccolith. blooms
21	MOD 25	coccolith concentration
22	MOD 25	calcite concentration
23	MOD 26	Diffuse Attenuation (K_490)
24	MOD 31	Phycocerythrobilin (PEB)
25	MOD 31	Phycourobilin (PUB)
26	MOD 21	Chlorophyll a (semianalytic)
27	MOD 21	Chlorophyll a (default)
28	MOD 22	Instantaneous PAR
29	MOD 22	Absorbed Radiation by Phyto. (ARP)
30	MOD 24	Gelbstoffe absorption coefficient
31	MOD 36	Chl. a. absorption coefficient
32-36	MOD 36	Total absorption,412..551
MOD27-1	MOD 27	Prim. Prod. Wkly Indexes
MOD27-2	MOD 27	Prim. Prod. Index Ann. Average
MOD27-3	MOD 27	Prim Prod. Annual HV Tot. New, Exp.
MOD28XD1	MOD 28	SST (skin, bulk), Day
MOD28XD2	MOD 28	SST (skin,bulk), Day, 4 microns
MOD28XN1	MOD 28	SST (skin,bulk), Night
MOD28XN2	MOD 28	SST(skin, bulk), Night, 4 microns

retrieval scatter for a local region to determine which channel combination(s) is(are) used.

J. Level 3 Spatial and Temporal Binning

An extensive series of quality and conditional flags at the pixel level is maintained through the Level 2 processing stages. Appropriate flags from the Level 1B product and cloud mask are carried forward as well. Additional flags and quality assessment indicators are determined at the granule level. Flag and mask definitions and threshold values are provided in detailed product documentation available through the Goddard Distributed Active Archive Center (GDAAC) and will likely undergo significant tuning in the postlaunch evaluation phase. The pixel level flags are used in the space binner and time binner programs to maintain data quality in the Level 3 products and play an important role in assigning quality in validation match-up data sets. Each Level 3 product (Table VI) is binned according to its own criteria and has a unique set of quality flag values for validation assessment. The general philosophy for binning is to include only the highest quality data available within any time period.

Both SST and Ocean Color products use similar binning strategies. The daily space-binned product forms the basis for longer time-period compositing, although adjustments are provided in which it is important to maintain quasiequal

representation of temporal periods. Thus, for the primary productivity product input, an annual period comprises 46 equally weighted weeks. For ease of access at Level 3, one file (including statistics and combined quality flag results) is created for each product at each time interval. Experience with the SST Pathfinder project showed the importance of maintaining proper temporal context of data for quality assessment [39]; therefore, both the preceding and following weekly fields are used to flag outlier values. This approach is carried forward with the bio-optical products as well and viewed as most appropriate for the atmospheric and surface reflectance fields.

K. Data Day

Another area where there is significant departure from heritage data products is in the definition of the MODIS data day, which applies to data at Level 3. The definition, and the advantages it confers, is discussed in detail by Evans (see [20, App. C]). The data-day concept basically uses an earth-centered frame of reference for demarcation of data observation times, rather than the orbital time on the satellite. In essence, near the date line, data are assigned to the Greenwich Mean Time (GMT) data day at the pixel level, rather than mapping entire scans or granules of data to the date indicated by the satellite clock at the time of observation. This removes some aliasing, which has characterized other missions. The advantages of this are that comparisons with *in-situ* observations are more accurate and the global data set is constrained to the same daylight date, which is important for comparisons with shipboard validation data sets of phytoplankton production. A disadvantage is that data from two days are required to observe nearly synoptic features that extend across the date line, and files from three days must be open while performing space and time binning. In other parts of the world, the user will be able to ignore the improved accuracy of data mapping.

IV. SUMMARY

MODIS incorporates significant improvements in radiometric quality and capabilities that result from careful analysis of the results from, and experience gained with, its heritage, precursor sensors. These improvements in requirements and instrument specifications for ocean requirements have been challenging, such as SNR, thermal NEDT, and radiometric accuracy, but have a firm basis in both theory and practice. They are coupled with commensurate or greater improvements in algorithms for standard ocean product accuracy and design, which should therefore provide significant enhancements in the ability to observe key oceanic properties and their variability as related to role of the ocean and response of oceanic ecosystems to climate variations. Coupled with these new and improved capabilities in the space and data segments is the requirement for improvements in product validation and assessment of uncertainty fields for the new products. Significant progress has been made in these areas as well over the past decade, in preparation for SeaWiFS and MODIS validation phases, and it is already bearing fruit. Full treatment is beyond the scope of this paper, but significant improvements in our ability to assess uncertainties in water-leaving spectral radiance (on

the order of $\pm 1\text{--}2\%$) and SST brightness temperatures (to less than $\pm 0.2\text{ K}$) by independent shipboard measurements are now in hand. Therefore, we have some confidence that the global ocean observational time series begun by MODIS should provide important oceanographic advances, both in the near-term and future long-term studies.

REFERENCES

- [1] M. R. Abbott and R. M. Letelier, "Going with the flow," in *Monitoring Algal Blooms: New Techniques for Detecting Large-Scale Environmental Changes*, Mati Kahru, Ed. Washington, DC: Landes Bioscience, to be published.
- [2] J. Aiken, G. F. Moore, C. C. Trees, S. B. Hooker, and D.K. Clark, "The SeaWiFS CZCS-type pigment algorithm," in *NASA Tech. Memo. 104 556*, vol. 29, S. B. Hooker and E. R. Firestone, Eds. Greenbelt, MD: NASA Goddard Space Flight Center, 1995, p. 34.
- [3] D. Anding and R. Kauth, "Estimation of sea surface temperature from space," *Remote Sens. Environ.*, vol. 1, pp. 217–220, 1970.
- [4] W. M. Balch, R. Evans, J. Brown, G. Feldman, C. McClain, and W. E. Esaias, "The remote sensing of ocean primary productivity: Use of a new data compilation to test satellite algorithms," *J. Geophys. Res.*, vol. 79, pp. 2279–293, 1992.
- [5] W. M. Balch, K. A. Kilpatrick, P. M. Holligan, and C. Trees, "The 1991 coccolithophore bloom in the central north Atlantic I—Optical properties and factors affecting their distribution," *Limnol. Ocean.*, vol. 41, pp. 1669–1683, 1996.
- [6] W. M. Balch, K. Kilpatrick, P. M. Holligan, D. Harbour, and E. Fernandez, "The 1991 coccolithophore bloom in the central north Atlantic II—Relating optics to coccolith concentration," *Limnol. Ocean.*, vol. 41, pp. 1684–1696, 1996.
- [7] R. A. Barnes, W. L. Barnes, W. E. Esaias, and C. R. McClain, "Prelaunch acceptance report for the SeaWiFS radiometer," in *NASA Tech. Memo. 104 556*, vol. 22, S. B. Hooker, E. R. Firestone, and J. A. Acker, Eds. Greenbelt, MD: NASA Goddard Space Flight Center, 1994, p. 32.
- [8] R. A. Barnes, A. W. Holmes, W. L. Barnes, W. E. Esaias, C. R. McClain, and T. Svitek, "SeaWiFS prelaunch radiometric calibration and spectral characterization," in *NASA Tech. Memo. 104 556*, vol. 23, S. O. B. Hooker, E. R. Firestone and J. A. Acker, Eds. Greenbelt, MD: NASA Goddard Space Flight Center, 1994, p. 55.
- [9] W. L. Barnes, T. Pagano, and V. V. Salomonson, "Prelaunch characteristics of the Moderate Resolution Imaging Spectroradiometer (MODIS) on EOS-AM1," this issue, pp. 1088–1100.
- [10] I. J. Barton, A. J. Prata, and D. T. Llewellyn-Jones, "The Along Track Scanning Radiometer—An analysis of coincident ship and satellite measurements," *Adv. Space Res.*, vol. 13, no. 5, p. 69, 1993.
- [11] I. J. Barton, M. Zavody, D. M. O'Brien, D. R. Cutten, R. W. Saunders, and D. T. Llewellyn-Jones, "Theoretical algorithms for satellite-derived sea surface temperatures," *J. Geophys. Res.*, vol. 94, p. 3365, 1989.
- [12] M. J. Behrenfeld and P. G. Falkowski, "Photosynthetic rates derived from satellite-based chlorophyll concentration," *Limnol. Ocean.*, vol. 42, pp. 1–20, 1997.
- [13] R. R. Bidigare, M. E. Ondrusek, J. H. Morrow, and D. A. Kiefer, "In vivo absorption properties of algal pigments," in *Proc. SPIE Ocean Opt. X*, 1990, vol. 1302, pp. 290–302.
- [14] W. P. Bissett, J. Patch, K. L. Carder, and Z. P. Lee, "Spectrophotometric determination of pigment packaging in high light, oceanic surface waters for remote sensing algorithms to estimate phytoplankton biomass," submitted for publication.
- [15] A. Bricaud, A. Morel, and L. Prieur, "Absorption by dissolved organic matter in the sea (yellow substance) in the UV and visible domains," *Limnol. Ocean.*, vol. 26, pp. 43–53, 1981.
- [16] J. T. Bradshaw and H. E. Fuelberg, "An evaluation of HIS interferometer soundings and their use in mesoscale analysis," *J. Appl. Meteorol.*, vol. 32, pp. 522–538, 1993.
- [17] C. W. Brown, "Classification of coccolithophore blooms on ocean color imagery," in *SeaWiFS Algorithms, Part 1 NASA Tech. Memo. 104 556*, vol. 28, S. B. Hooker, E. R. Firestone, and J. A. Acker, Eds. Greenbelt, MD: NASA Goddard Space Flight Center, 1995, p. 38.
- [18] C. W. Brown and J. A. Yoder, "Coccolithophorid blooms in the global ocean," *J. Geophys. Res.*, vol. 99, pp. 7467–7482, 1994.
- [19] W. L. Butler, "Energy distribution in the photochemical apparatus of photosynthesis," *Ann. Rev. Plant Physiol.*, vol. 29, pp. 345–378, 1978.
- [20] J. W. Campbell, J. M. Blaisdell, and M. Darzi, "Level-3 SeaWiFS data products: Spatial and temporal binning algorithms," in *NASA Tech.*

- Memo. 104 566*, vol. 32. Greenbelt, MD: NASA Goddard Space Flight Center, 1995, p. 63.
- [21] D. G. Capone, J. P. Zehr, H. W. Paerl, B. Bergman, and E. J. Carpenter, "Trichodesmium, a globally significant marine cyanobacterium," *Science*, vol. 276, pp. 1221–1229, 1997.
- [22] K. L. Carder, S. K. Hawes, Z. Lee, and F. R. Chen, MODIS Ocean Science Team ATBD, Case 2 Chlorophyll *a*, version 4, 1997.
- [23] ———, MODIS Ocean Science Team ATBD, Instantaneous Photosynthetically Available Radiation and Absorbed Radiation by Phytoplankton, version 4, 1997.
- [24] K. L. Carder, S. K. Hawes, and Z. P. Lee, "SeaWiFS algorithm for chlorophyll *a* and colored dissolved organic matter in subtropical environments," submitted for publication.
- [25] R. J. Charleson, J. E. Lovelock, M. O. Andreae, and S. G. Warren, "Oceanic phytoplankton, atmospheric sulfur, cloud albedo, and climate," *Nature*, vol. 326, pp. 655–661, 1987.
- [26] W. S. Chamberlin and J. Marra, "Estimation of photosynthetic rate from measurements of natural fluorescence: Analysis of the effects of light and temperature," *Deep Sea Res.*, vol. 39, pp. 1695–1706, 1992.
- [27] W. S. Chamberlin, C. R. Booth, D. A. Kiefer, J. H. Morrow, and C. R. Murphy, "Evidence for a simple relationship between natural fluorescence, photosynthesis and chlorophyll in the sea," *Deep Sea Res.*, vol. 37, pp. 951–973, 1990.
- [28] D. K. Clark "Phytoplankton algorithms for the Nimbus-7 CZCS," in *Oceanography from Space*, JFR Gower, Ed. New York: Plenum, 1981, pp. 227–238.
- [29] D. K. Clark, H. R. Gordon, K. J. Voss, Y. Ge, W. Broenkow, and C. Trees, "Validation of atmospheric correction over the oceans," *J. Geophys. Res.*, to be published.
- [30] P. Cornillon and L. Stramma, "The distribution of diurnal sea surface warming events in the western Sargasso Sea," *J. Geophys. Res.*, vol. 98C, no. 6, pp. 11811–11815, 1985.
- [31] C. Cox and W. Munk, "Measurements of the roughness of the sea surface from photographs of the Sun's glitter," *J. Opt. Soc. Amer.*, vol. 44, pp. 838–850, 1954.
- [32] M. E. Culver and M. J. Perry, "Detection of phycoerythrin fluorescence in upwelling irradiance spectra," *EOS Trans. AGU*, vol. 75, p. 233, 1994.
- [33] P. Y. Deschamps and T. Phulpin, "Atmospheric corrections of infrared measurements of sea surface temperature using channels at 3.7 μm , 11 μm and 12 μm ," *Boundary Layer Meteorol.*, vol. 18, pp. 131–143, 1980.
- [34] R. C. Dugdale and J. J. Goering, "Uptake of new and regenerated forms of nitrogen in primary productivity," *Limnol. Ocean.*, vol. 12, pp. 196–206, 1967.
- [35] T. Edwards, R. Browning, J. Delderfield, D. J. Lee, K. A. Lidiard, R. S. Milborrow, P. H. McPherson, S. C. Peskett, G. M. Toplis, H. S. Taylor, I. Mason, G. Mason, A. Smith, and S. Stringer, "The Along Track Scanning Radiometer—Measurement of sea-surface temperature from ERS-1," *J. Brit. Interplanetary Soc.*, vol. 43, p. 160, 1990.
- [36] W. E. Esaias, R. Iverson, and K. Turpie, "Ocean province classification using ocean color data: observing biological signatures of variations in physical dynamics," *Global Change Biol.*, to be published.
- [37] W. E. Esaias, "Remote sensing of oceanic phytoplankton: Present capabilities and future goals," in *Primary Productivity in the Sea*, P. G. Falkowski, Ed. Plenum, New York, 1980, pp. 321–337.
- [38] R. L. Evans and H. R. Gordon, "CZCS 'System Calibration:' A retrospective examination," *J. Geophys. Res.*, vol. 99, pp. 7293–7307, 1994.
- [39] R. H. Evans and G. Podestá, "AVHRR Pathfinder: SST approach and results," *EOS Trans.*, AGU fall meeting, San Francisco, CA, vol. 77, p. 46, 1996.
- [40] P. G. Falkowski and Z. Kolber, "Estimation of phytoplankton photosynthesis by active fluorescence," in *Proc. ICES Mar. Sci. Symp.*, vol. 197, pp. 92–103, 1993.
- [41] P. G. Falkowski and The Ocean Primary Productivity Working Group, "Using satellite data to derive primary productivity in the world oceans," in *NASA Technical Memorandum 104556*, vol. 36, S. B. Hooker and E. R. Firestone, Eds. Greenbelt, MD: NASA Goddard Space Flight Center, 1997.
- [42] G. C. Feldman, W. Esaias, C. McClain, J. Elrod, N. Maynard, and D. Endres, "Ocean Color: Availability of the global data set," *EOS Trans. AGU*, vol. 70, pp. 634–641, 1989.
- [43] J. Fischer and U. Kronfeld, "Sun-stimulated chlorophyll fluorescence 1: Influence of oceanic properties," *Int. J. Remote Sensing*, vol. 11 pp. 2125–2147, 1990.
- [44] R. Frouin, M. Schwindling, and P. Y. Deschamps, "Spectral reflectance of sea foam in the visible and near-infrared: *In-situ* measurements and implications for remote sensing of ocean color and aerosols," *J. Geophys. Res.*, vol. 101C, pp. 14 361–14 371, 1996.
- [45] H. R. Gordon, "Removal of atmospheric effects from satellite imagery of the oceans," *Appl. Opt.*, vol. 17, pp. 1631–1636, 1978.
- [46] ———, "Diffuse reflectance of the ocean: The theory of its augmentation by chlorophyll *a* fluorescence at 685 nm," *Appl. Opt.*, vol. 18, pp. 1161–1166, 1979.
- [47] ———, "Atmospheric correction of ocean color imagery in the earth observing system era," *J. Geophys. Res.*, vol. 102D, 17,081–17,106, 1997.
- [48] H. R. Gordon, J. W. Brown, and R. H. Evans, "Exact Rayleigh scattering calculations for use with the Nimbus-7 Coastal Zone Color Scanner," *Appl. Opt.*, vol. 27, pp. 862–871, 1988.
- [49] H. R. Gordon, O. B. Brown, R. H. Evans, J. W. Brown, R. C. Smith, K. S. Baker, and D. K. Clark, "A semi-analytic radiance model of ocean color," *J. Geophys. Res.*, vol. 93D, pp. 10909–10924, 1988.
- [50] H. R. Gordon and D. K. Clark, "Atmospheric effects in the remote sensing of phytoplankton pigments," *Boundary Layer Meteorol.*, vol. 18, pp. 299–313, 1980.
- [51] H. R. Gordon, D. K. Clark, J. L. Mueller, and W. A. Hovis, "Phytoplankton pigments derived from the Nimbus-7 CZCS: initial comparisons with surface measurements," *Science*, vol. 210, pp. 63–66, 1980.
- [52] H. R. Gordon and D. K. Clark, "Clear water radiances for atmospheric correction of Coastal Zone Color Scanner imagery," *Appl. Opt.*, vol. 20, pp. 4175–4180, 1981.
- [53] H. R. Gordon, D. K. Clark, J. W. Brown, O. B. Brown, R. H. Evans, and W. W. Broenkow, "Phytoplankton pigment concentrations in the middle Atlantic bight: Comparison of ship determinations and Coastal Zone Color Scanner measurements," *Appl. Opt.*, vol. 22, pp. 20–36, 1983.
- [54] H. R. Gordon, T. Du, and T. Zhang, "Remote sensing ocean color and aerosol properties: resolving the issue of aerosol absorption," *Appl. Opt.*, to be published.
- [55] H. R. Gordon and A. Y. Morel, *Remote Assessment of Ocean Color for Interpretation of Satellite Visible Imagery: A Review*. New York: Springer-Verlag, 1983, p. 114.
- [56] H. R. Gordon and M. Wang, "Influence of oceanic whitecaps on atmospheric correction of SeaWiFS, applied optics," *Appl. Opt.*, vol. 33, pp. 7754–7763, 1994.
- [57] ———, "Retrieval of water-leaving radiance and aerosol optical thickness over the oceans with SeaWiFS: A preliminary algorithm," *Appl. Opt.*, vol. 33, pp. 443–452, 1994.
- [58] J. F. R. Gower and G. A. Borstad, "Mapping of phytoplankton by solar-stimulated fluorescence using an imaging spectrometer," *Int. J. Remote Sensing*, vol. 11, pp. 313–320, 1990.
- [59] W. W. Gregg, "Analysis of orbit selection for SeaWiFS: Ascending versus descending node," in *NASA Tech. Memo. 104 556*, vol. 2, S. B. Hooker and E. R. Firestone, Eds. Greenbelt, MD: NASA Goddard Space Flight Center, 1992, p. 16.
- [60] W. W. Gregg and K. L. Carder, "A simple spectral solar irradiance model for cloudless maritime atmospheres," *Limnol. Ocean.*, vol. 35, no. 8, pp. 1657–1675, 1990.
- [61] W. W. Gregg and R. H. Woodward, "Improvements in coverage frequency of ocean color: Combining data from SeaWiFS and MODIS," this issue, pp. 1350–1353.
- [62] B. Guenther, W. L. Barnes, E. J. Knight, J. Barker, J. Harden, R. Weber, M. Roberto, G. D. Godden, H. Montgomery, and P. Abel, "Modis calibration: A brief review of the strategy for the at-launch calibration approach," *J. Atmos. Ocean. Technol.*, vol. 13, no. 2, pp. 274–285, 1996.
- [63] F. E. Hoge and R. N. Swift, "Airborne simultaneous spectroscopic detection of laser-induced water-Raman backscatter and fluorescence from chlorophyll *a* and other naturally occurring pigments," *Appl. Opt.*, vol. 20, pp. 3197–3205, 1981.
- [64] ———, "Active-passive correlation spectroscopy: A new technique for identifying ocean color algorithm spectral regions," *Appl. Opt.*, vol. 25, pp. 2571–2583, 1986.
- [65] F. E. Hoge and R. N. Swift, "Phytoplankton accessory pigments: Evidence for the influence of phycoerythrin on the submarine light field," *Remote Sens. Environ.*, vol. 34, pp. 19–25, 1990.
- [66] F. E. Hoge, and P. E. Lyon, "Satellite retrieval of inherent optical properties by linear matrix inversion of oceanic radiance models: An analysis of model and radiance measurement errors," *J. Geophys. Res.*, vol. 101, pp. 16,631–48, 1996.
- [67] P. M. Holligan, E. Fernandez, J. Aiken, W. M. Balch, P. Boyd, P. H. Burkhill, M. Finch, S. B. Groom, G. Malin, K. Muller, D. A. Purdie, C. Robinson, C. C. Trees, S. M. Turner, and P. van der Wal, "A biogeochemical study of the coccolithophore *Emiliana huxleyi* in the North Atlantic," *Global Biogeochem. Cycles*, vol. 7, pp. 879–900, 1993.
- [68] K. L. Howard, "Estimating global ocean primary production using satellite-derived data," M.S. thesis, Univ. of Rhode Island, Kingston,

- 1995, p. 98.
- [69] R. L. Iverson and W. Esaias, "Ocean phytoplankton total carbon and new production, and export production estimated using empirical equations and CZCS data," submitted for publication
- [70] JGOFS Photosynthesis Measurements Task Team, "Measurement of the parameters of photosynthesis: Light absorption and quantum yield of photosynthesis derived from P versus E determinations," *J. Plankton Res.*, to be published.
- [71] D. Kamykowski, "A preliminary biophysical model of the relationship between temperature and plant nutrients in the upper ocean," *Deep Sea Res.*, vol. 34, no. 7, pp. 1067–1079, 1987.
- [72] D. M. Karl, R. Letelier, C. Hebel, L. Tupas, J. Dore, J. Christian, and C. Winn, "Ecosystem changes in the North Pacific subtropical gyre attributed to the 1991–92 El Niño," *Nature*, vol. 373, pp. 230–234, 1995.
- [73] D. A. Kiefer, W. S. Chamberlin, and C. R. Booth, "Natural fluorescence of chlorophyll *a*: relationship to photosynthesis and chlorophyll concentration in the western South Pacific gyre," *Limnol. Ocean.*, vol. 34, pp. 868–881, 1989.
- [74] M. Kishino, S. Sugihara, and N. Okami, "Influence of fluorescence of chlorophyll *a* on underwater upward irradiance spectrum," *La Mer*, vol. 22, pp. 224–232, 1984.
- [75] Z. Lee, K. L. Carder, S. K. Hawes, R. G. Steward, T. G. Peacock, and C. O. Davis, "A model for interpretation of hyperspectral remote-sensing reflectance," *Appl. Opt.*, vol. 33, pp. 5721–5732, 1994.
- [76] R. M. Letelier and M. R. Abbott, "An analysis of chlorophyll fluorescence algorithm for the Moderate Resolution Imaging Spectrometer (MODIS)," *Remote Sens. Environ.*, vol. 58, pp. 215–223, 1996.
- [77] R. M. Letelier, M. R. Abbott, and D. M. Karl, "Chlorophyll natural fluorescence response to upwelling events in the Southern Ocean," *Geophys. Res. Lett.*, vol. 24, pp. 409–412, 1997.
- [78] D. T. Llewellyn-Jones, P. J. Minnett, R. W. Saunders, and A. M. Závody, "Satellite multichannel infrared measurements of sea surface temperature of the N.E. Atlantic Ocean using AVHRR/2," *Q. J. R. Meteorol. Soc.*, vol. 110, pp. 613–631, 1984.
- [79] A. Longhurst, S. Sathyendranath, T. Platt, and C. Caverhill, "An estimate of global primary production in the ocean from satellite radiometer data," *J. Plankton Res.*, vol. 17 pp. 1245–1271, 1995.
- [80] C. R. McClain, K. R. Arrigo, W. E. Esaias, M. Darzi, F. S. Patt, R. H. Evans, J. W. Brown and, R. A. Barnes, and L. Kumar, "SeaWiFS algorithms, Part 1," in *NASA Tech. Memo. 104556*, vol. 28, S. B. Hooker, E. R. Firestone and J. A. Acker, Eds. Greenbelt, MD: NASA Goddard Space Flight Center, 1995, p. 38.
- [81] C. R. McClain, G. C. Feldman, and, W. E. Esaias, "Oceanic biological productivity," in *Atlas of Satellite Observations Related to Global Change*, R. Gurney, J. L. Foster, and C. L. Parkinson, Eds. Cambridge, U.K.: Cambridge Univ. Press, 1993, pp. 251–263.
- [82] E. P. McClain, "Multiple atmospheric—window techniques for satellite derived sea surface temperatures," in *Oceanography from Space*, J. F. R. Gower, Ed. New York: Plenum, 1981, ch. 13.
- [83] E. P. McClain, W. G. Pichel, C. C. Walton, Z. Ahmed, and J. Sutton, "Multi-channel improvements to satellite derived global sea surface temperatures," *Proc. XXIV COSPAR, Adv. Space Res.*, vol. 2, pp. 43–47, 1983.
- [84] E. P. McClain, W. G. Pichel, and C. C. Walton, "Comparative performance of AVHRR-based multichannel sea surface temperatures," *J. Geophys. Res.*, vol. 90C, pp. 11587–11601, 1985.
- [85] P. J. Minnett, "Satellite infrared scanning radiometers—AVHRR & ATSR," in *Microwave Remote Sensing for Oceanographic and Marine Weather-Forecast Models*, R. A. Vaughn, Ed. Norwell, MA: Kluwer, 1990.
- [86] P. J. Minnett, "Sea surface temperature measurements from the along-track scanning radiometer on ERS-1," in *Oceanographic Applications of Remote Sensing*, M. Ikeda and F. Dobson, Eds. Boca Raton, FL: CRC, 1995, pp. 131–143, 1995.
- [87] ———, "The along-track scanning radiometer: Instrument details," in *Oceanographic Applications of Remote Sensing*, M. Ikeda and F. Dobson, Eds. Boca Raton, FL: CRC, 1995, pp. 461–472.
- [88] P. J. Minnett, and R. H. Evans, "Evidence of effects of aerosols on thermal infrared measurements from satellites," in *Proc. 2nd ARM Aerosol Workshop*, Nov. 1996.
- [89] J. L. Mueller and R. W. Austin, "Ocean optics protocols for SeaWiFS validation, Revision 1," in *NASA Tech. Memo. 104556*, vol. 25, S. B. Hooker, E. R. Firestone and J. A. Acker, Eds. Greenbelt, MD: NASA Goddard Space Flight Center, 1995, p. 66.
- [90] C. T. Mutlow, D. T. Llewellyn-Jones, A. M. Závody, and I. J. Barton, "Sea surface temperature measurements by the along-track scanning radiometer on the ERS-1 satellite: Early results," *J. Geophys. Res.*, vol. 99, pp. 22575–22588, 1994.
- [91] R. A. Neville and J. F. R. Gower, "Passive remote sensing of phytoplankton via chlorophyll *a* fluorescence," *J. Geophys. Res.*, vol. 82C, pp. 3487–3493, 1977.
- [92] J. R. O'Reilly and S. Maritorena, "Ocean color chlorophyll algorithms for SeaWiFS," submitted for publication.
- [93] C. Prabhakara, G. Dalu, and V. G. Kunde, "Estimation of sea surface temperature from remote sensing in the 11 μm to 13 μm window region," *J. Geophys. Res.*, vol. 79, no. 12, pp. 1744–1749.
- [94] I. S. Robinson, N. C. Wells, and H. Charnock, "The sea surface thermal boundary layers and its relevance to the measurement of sea surface temperature by airborne and space borne radiometers," *Int. J. Remote Sensing*, vol. 5, pp. 19–46, 1984.
- [95] V. V. Salomonson, W. L. Barnes, P. Maymon, H. E. Montgomery, and H. Ostrow, "MODIS: Advanced facility instrument for studies of the earth as a system," *IEEE Trans. Geosci. Remote Sensing*, vol. 27, pp. 145–153, Mar. 1989.
- [96] J. L. Sarmiento and C. Le Quere, "Oceanic carbon dioxide uptake in a model of century-scale global warming," *Science*, vol. 274, pp. 1346–1350, 1996.
- [97] P. Schluessel, W. J. Emery, H. Grassl, and T. Mammen, "On the bulk-skin temperature difference and its impact on satellite remote sensing of sea surface temperatures," *J. Geophys. Res.*, vol. 95, pp. 13341–13356, 1990.
- [98] A. Schwalb, "Modified version of the improved TIROS operational satellite (ITOS D-G)," *NOAA TM NESS 35*, 1973, p. 48. Available from NTIS as COM-72-10547 at <http://www.ntis.gov/>.
- [99] ———, "The TIROS/NOAA A-G satellite series," *NOAA TM NESS 95*, 1978, p. 75. Available from NTIS.
- [100] E. P. Shettle and R. W. Fenn, "Models for the aerosols of the lower atmosphere and the effects of humidity variations on their optical properties," Air Force Geophys. Lab., Hanscom AFB, MA, AFGL-TR-79-0214, 1979.
- [101] A. H. Smith, R. W. Saunders, and A. M. Závody, "The validation of ATSR using aircraft radiometer data over the Tropical Atlantic," *J. Atmos. Ocean. Technol.*, vol. 11, pp. 789–800, 1994.
- [102] C. C. Walton, "Nonlinear multichannel algorithms for estimating sea-surface temperature with AVHRR satellite data," *J. Appl. Meteorol.*, vol. 27, pp. 115–124, 1988.
- [103] C. C. Walton, E. P. McClain, and J. F. Sapper, "Recent changes in satellite-based multi-channel sea surface temperature algorithms," *Preprints, Marine Technol. Soc. Meeting, MTS '90*, Marine Technol. Soc., Washington, DC, Sept. 1990.
- [104] M. Weinreb, "Real-world calibration of GOES-8 and -9 sensors," in *Proc. SPIE Int. Symp. Opt. Sci., Eng., and Instrumen., GOES-8 Beyond*, E. R. Washell, Ed., Denver, CO, Aug. 4–9, 1996., p. 888.
- [105] J. A. Yoder, C. R. McClain, G. C. Feldman, and W. E. Esaias, "Annual cycles of phytoplankton chlorophyll concentrations in the global ocean: A satellite view," *Global Biogeochem. Cycles*, vol. 7, pp. 181–193, 1993.
- [106] A. M. Závody, C. T. Mutlow, and D. T. Llewellyn-Jones, "A radiative transfer model for sea surface temperature retrieval for the Along-Track Scanning Radiometer," *J. Geophys. Res.*, vol. 100, pp. 937–, 1995.
- [107] J. E. A. Selby, F. X. Kneizys, H. H. Chetwynd, Jr., and R. A. McClatchey, "Atmospheric transmittance/radiance: Computer code LOWTRAN 4," AFGL-TR-78-0053, Environ. Res. Papers 626, 1978. Available from NTIS at <http://www.ntis.gov/>.

Wayne E. Esaias received the B.A. degree from The Johns Hopkins University, Baltimore, MD, in 1967 and the M.S. and Ph.D. degrees in biological oceanography from Oregon State University, Corvallis, in 1969 and 1973, respectively.

He has been a Biological Oceanographer at NASA's Goddard Space Flight Center, Greenbelt, MD, since 1984, specializing in satellite observations of ocean optical properties (ocean color) to study phytoplankton distributions on regional and global scales. He led the Global CZCS reprocessing team effort, developed the Ocean Data Acquisition System (ODAS), an airborne color sensor, and was Project Scientist for the Goddard SeaWiFS Project until 1994, when he became Full-Time Leader of the MODIS Instrument Ocean Team. He headed the MODIS Instrument Science Requirements Panel while at NASA Headquarters, Washington, DC, from 1982 to 1984.

Mark R. Abbott received the B.S. degree in conservation of natural resources from the University of California, Berkeley, in 1974 and the Ph.D. degree in ecology from the University of California, Davis, in 1978.

He has been a Professor in the College of Oceanic and Atmospheric Sciences, Oregon State University, Corvallis, since 1988. His research focuses on the interaction of biological and physical processes in the upper ocean and relies on both remote-sensing and field observations. He deployed the first array of bio-optical moorings in the Southern Ocean as part of the United States Joint Global Ocean Flux Study. He is currently a member of the MODIS and SeaWiFS science teams.

Dr. Abbott chairs the Committee on Earth Studies for the National Academy of Sciences.

Ian Barton, photograph and biography not available at the time of publication.

Otis B. Brown received the B.S. degree in physics from North Carolina State University, Raleigh, the M.S. degree in theoretical physics and the Ph.D. degree in physics, with a specialty in underwater optics, both from the University of Miami, Coral Gables, FL.

He is Dean of the Rosenstiel School of Marine and Atmospheric Science and Professor in the Division of Meteorology and Physical Oceanography, both located at the University of Miami. His research interests include radiative transfer in the ocean-atmosphere system for visible light, particulate scattering in sea water, satellite infrared observations of sea surface temperature in the Atlantic, Pacific, and Indian oceans, kinematical studies of warm core rings based on infrared tracking, transient processes in western boundary currents, and evolution of spring bloom on shelf/slope regions based on visible satellite data. He was a participant in ONR Southern Ocean Studies and Kuroshio Extension Recirculation Programs, the JGOFS Arabian Sea Expedition, and the EOS/MODIS program.

Janet W. Campbell received the B.A. degree in 1966, the M.A. degree in 1968, both in mathematics, and the Ph.D. degree in statistics in 1973, all from the Virginia Polytechnic Institute, Blacksburg.

She was with NASA Langley Research Center, Hampton, VA, as an Aerospace Technologist between 1967 and 1982. Between 1982 and 1993, she was a Research Scientist at the Bigelow Laboratory for Ocean Sciences and has been involved in ocean color remote-sensing research since 1976. She is a Research Associate Professor at the Institute for the Study of Earth, Oceans, and Space, University of New Hampshire, Durham. She is also currently serving as Program Manager for NASA's Ocean Biology Program at NASA Headquarters, Washington, DC. She is a Member of the SeaWiFS and MODIS science teams.

Kendall L. Carder received the Ph.D. degree from Oregon State University, Corvallis, in 1970.

He was with the Faculty of Oregon State University. He also served two years (1980–1982) at NASA Headquarters, Washington, DC, initiating the Global Ocean Productivity Program. He is currently a Professor in the Marine Science Department, University of South Florida, Tampa. He has developed ocean color algorithms for chlorophyll *a*, colored dissolved organic matter, fluorescence efficiency, bathymetry, and bottom albedo for use with various aircraft and satellite spectrometers. He serves on the SeaWiFS, Ocean Color and Temperature Scanner, Landsat, and MODIS science teams.

Dennis K. Clark received a degree from Pennsylvania State University, University Park, in 1964.

He has been with NOAA for 33 years and is currently the Marine Optics Team Leader at the Oceanic Research and Applications Division, NOAA/NESDIS/ORA, Camp Springs, MD. He has been active in ocean color research, beginning with the Nimbus-7 Experiment Team, and was responsible for the at-sea validation effort for CZCS. He is a Member of the SeaWiFS and MODIS science teams.

Robert H. Evans received the B.S. degree in 1966, the M.S. degree in 1970, and the Ph.D. degree in electrical engineering from North Carolina State University, Raleigh, in 1973.

He has been a Research Professor at the Rosenstiel School of Marine and Atmospheric Science, University of Miami, Coral Gables, FL, since 1974. He was involved with the NIMBUS-7 Coastal Zone Color Scanner, developing an instrument calibration strategy and the processing methodology that provided the first global ocean color time series. He is currently a Science Team Member for SeaWiFS and MODIS investigations.

Frank E. Hoge received the B.S. degree from Concord College, Athens, WV, in 1960 and the M.S. and Ph.D. degrees from West Virginia University, Morgantown, in 1961 and 1964, respectively, all in physics.

He has been a NASA Physicist since 1966, specializing in the application of lasers to geophysical research. He has served as Project Scientist for the Airborne Oceanographic Lidar (AOL) since 1975, developing techniques for the retrieval and mapping of oceanic optical properties and constituents by laser-induced fluorescence. He is currently located at NASA's Wallops Flight Facility, Goddard Space Flight Center, Wallops Island, VA. He has participated in many oceanographic campaigns and developed both passive and laser methods for determining important bio-optical constituent concentrations. He is a Science Team Member of MODIS, SeaWiFS, OCTS, POLDER, SIMBIOS, and GLL.

Dr. Hoge received the Goddard Space Flight Center Exceptional Service Award in 1989. The AOL Team received the NASA Group Achievement Award in 1988.

Howard R. Gordon, for a photograph and biography, see this issue, p. 1087.

William M. Balch received the B.A. degree in 1980 from Cornell University, Ithaca, NY, and the Ph.D. degree from Scripps Institute of Oceanography, University of California, San Diego, in 1985.

He was an Associate Professor at the Rosenstiel School of Marine and Atmospheric Science, University of Miami, Coral Gables, FL, between 1988 and 1995. He has been a Senior Research Scientist at the Bigelow Laboratory for Ocean Sciences, West Boothbay Harbor, ME, since 1995. He has studied calcifying algae, their biology, biogeochemistry, and optics. The optical work has been directed toward a MODIS algorithm for the determination of suspended calcium carbonate in the sea. He is a Member of the SeaWiFS and SIMBIOS teams as well as a Subcontractor on the MODIS project.

Richard Letelier, photograph and biography not available at the time of publication.

Peter J. Minnett studied natural science at Oxford University, Oxford, U.K., and received the Ph.D. degree in physical oceanography from the University of Southampton, Southampton, U.K., in 1978.

He is a Research Professor in the Meteorology and Physical Oceanography Division, Rosenstiel School of Marine and Atmospheric Science, University of Miami, Coral Gables, FL. He is also an Adjunct Professor at North Carolina State University, Raleigh, and the State University of New York, Stony Brook. He has been involved in satellite remote sensing since 1981 and is an Associate Science Team Member for MODIS.