

Supplementary Fig.1 Tubbs/NSA-98-0995 (T/N) population linkage maps

1A1

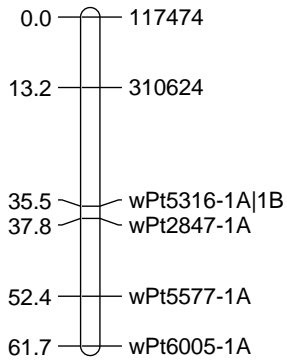

1A2

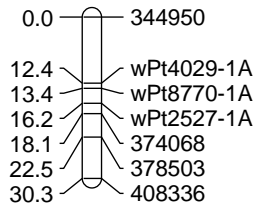

1A3

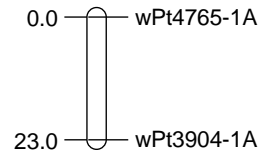

1B1

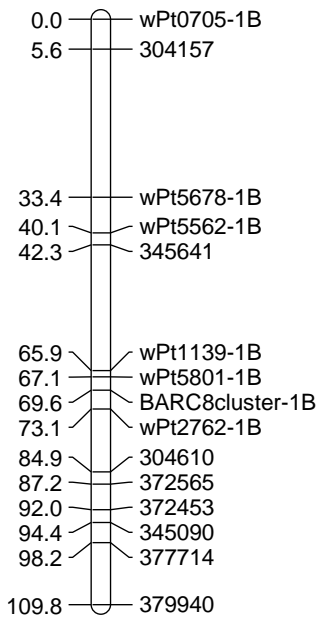

1B2

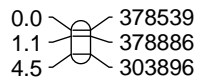

1B3

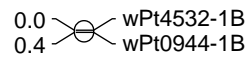

1D

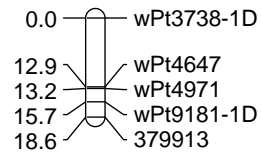

2A1

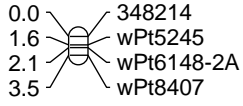

2A2

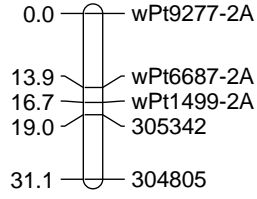

2A3

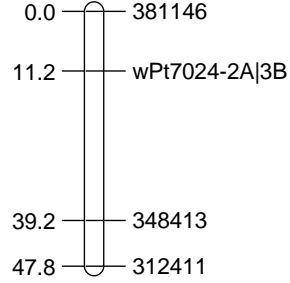

2B1

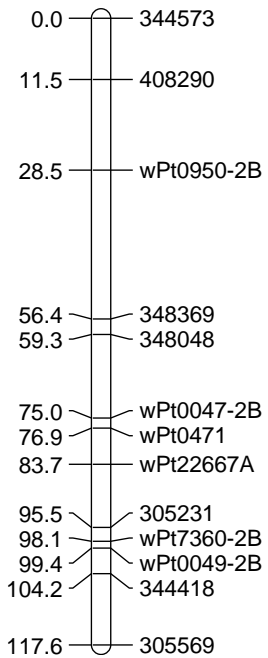

2B2

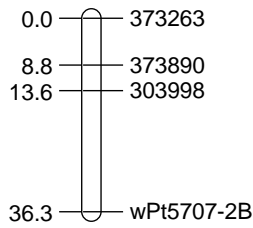

2B3

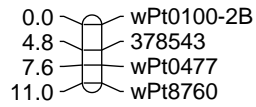

2D1

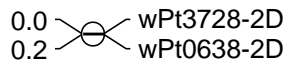

2D2

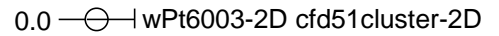

3A1

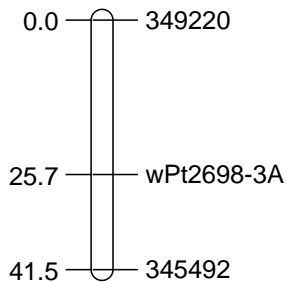

3A2

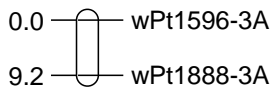

3A3

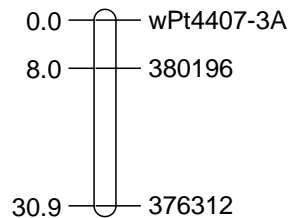

3B1

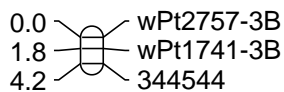

3B2

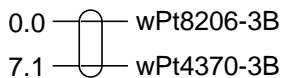

3B3

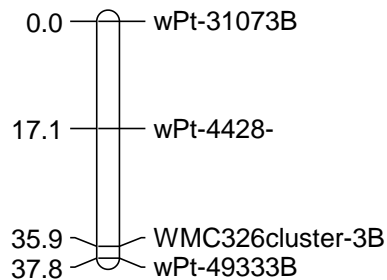

3B4

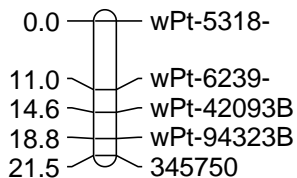

3B5

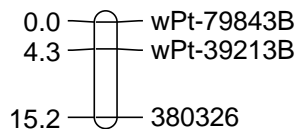

3D1

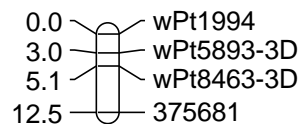

4A

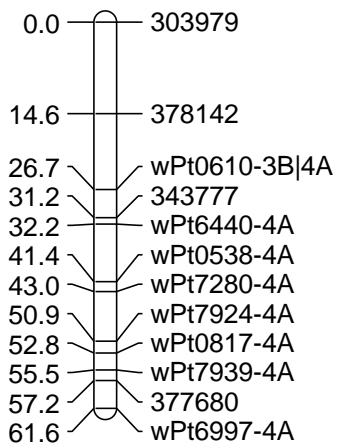

4B

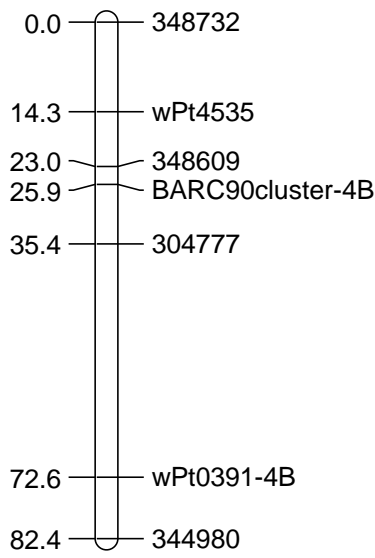

5A1

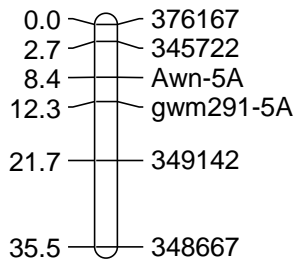

5A2

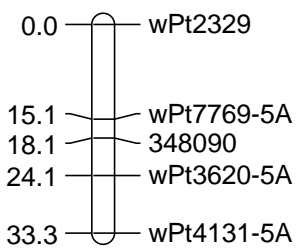

5A3

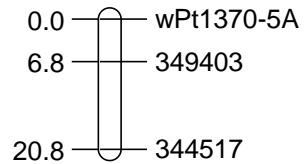

5B1

5B2

5B3

5D

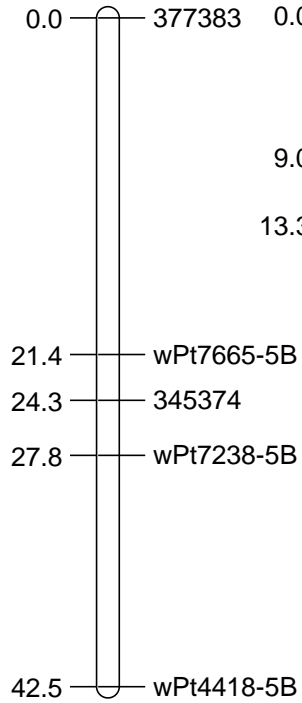
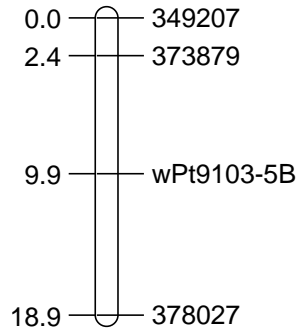
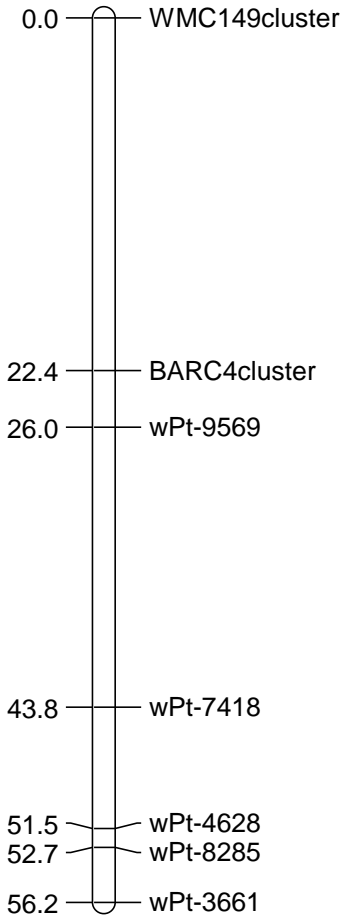

6A1

6A2

6A3

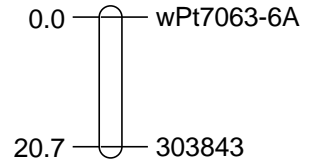
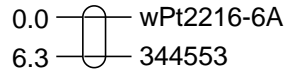
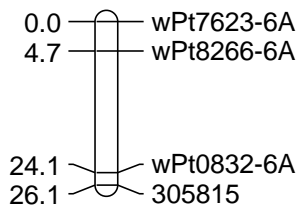

6B1

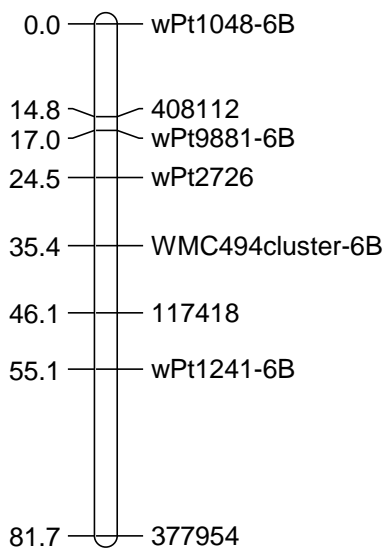

6B2

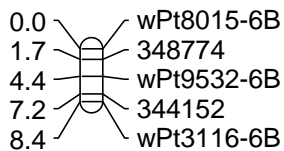

6B3

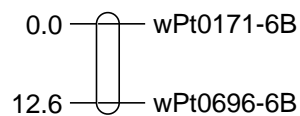

7A1

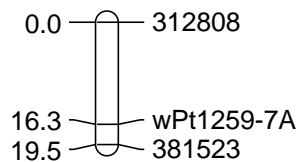

7A2

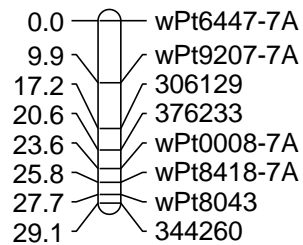

7B1

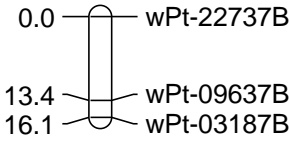

7B2

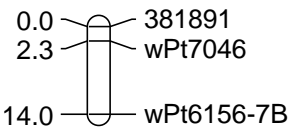

7B3

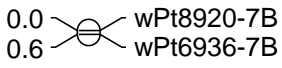

7D1

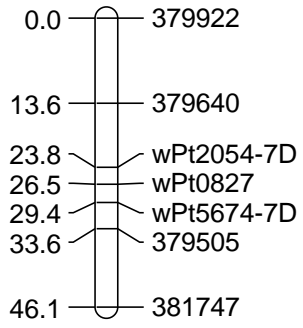

7D2

