

AN ABSTRACT OF THE THESIS OF

Ming Shao for the degree of Master of Science
in Forest Products presented on December 12, 1989

Title: Thermal Properties of Wood fiber Networks

Abstract approval: ~~Signature redacted for privacy.~~

~~_____~~
P. E. Humphrey

The standard (ASTM) steady-state method for determining the thermal conductivity of insulating materials (like wood based composite materials) is time-consuming, and its use is therefore limited to dry material; moisture migration occurs in hydrated materials and this limits accuracy. The proposed unsteady-state method is fast and therefore enables thermal properties of hygroscopic materials to be measured. The specimens are pressed by hot platens and the temperature rise inside them is measured. By comparing experimental data with the theoretical solutions of the "heat equation", thermal properties are determined using error minimization computer programs. The thermal properties of wood fiber networks have been measured as a function of density and moisture content. The results will be used in computer models which simulate the hot pressing of wood based composites.

Thermal Properties of Wood Fiber Networks

by

Ming Shao

A THESIS

submitted to

Oregon State University

in partial fulfillment of
the requirement for the
degree of

Master of Science

Completed December 12, 1989

Commencement June, 1990

APPROVED:

Signature redacted for privacy.

Associate Professor of Forest Products
in charge of major

Signature redacted for privacy.

Head of Department of Forest Products

Signature redacted for privacy.

Dean of Graduate School

Data thesis is presented December 12, 1989

Typed by Ming Shao

TABLE OF CONTENTS

	page
CHAPTER I INTRODUCTION	1
CHAPTER II LITERATURE REVIEW	4
2.1 Introduction to Heat Transfer	4
2.2 Conductive Heat Transfer	5
2.2.1 Thermal Conductivity	5
2.2.2 Specific Heat	6
2.2.3 Thermal Diffusivity	7
2.3 Methods of Measuring Thermal Properties	8
2.3.1 Steady-state Methods	8
2.3.2 Unsteady-state Methods	10
2.4 Thermal Properties of Wood and Wood-based Composites	21
2.4.1 Thermal Conductivity	21
2.4.2 Specific Heat	27
2.4.3 Thermal Diffusivity	29
CHAPTER III PRINCIPLE OF THE METHOD	31
3.1 Introduction	31
3.2 Underlying Principle of the Method	32
3.3 Experimental Methods	34
CHAPTER IV MATHEMATICAL AND NUMERICAL ANALYSIS	42
4.1 Determination of Thermal Diffusivity	42
4.1.1 Mathematics - Method I	42
4.1.2 Results of Numerical Analysis for Method I	46
4.2 Determination of Specific Heat and Thermal Conductivity	54
4.2.1 Mathematics - Method II	54

4.2.2	Results of Numerical Analysis	57
CHAPTER V	DISCUSSION OF RESULTS	67
5.1	Accuracy of Results	67
5.2	Similarities between the Experimental Method and Commercial Hot Pressing Operations	70
5.3	Discussion of Results	73
5.3.1	Thermal Diffusivity	73
5.3.2	Thermal Conductivity	76
5.3.3	Specific Heat	79
CHAPTER VI	CONCLUSIONS AND RECOMMENDATIONS	81
6.1	Conclusions from the Current Research	81
6.2	Recommendations for Future Research	82
	BIBLIOGRAPHY	83
	APPENDICES	86
APPENDIX A	Fortran Program for Method I	86
APPENDIX B	Fortran Program for Method II	89

LIST OF FIGURES

	page
Figure 2.1. Experimental arrangement suggested by Vernotte (from Clark, 1950)	11
Figure 2.2. Experimental arrangement of piles (from Clarke and Kingston, 1950)	12
Figure 2.3. Experimental arrangement of transient method (Clark, 1954)	15
Figure 2.4. Experimental arrangement used by Ward and Skaar (1963)	17
Figure 2.5. (a) Slabs between two metal plates (b) Experimental arrangement by Nanassy (1978)	19
Figure 2.6. Sample chart from waferboard test (from Nanassy, 1978)	21
Figure 2.7. Dependence of the thermal conductivity on moisture content of wood (from Kollmann, 1968)	23
Figure 2.8. Thermal conductivity of oven-dry wood (from Gammon, 1987)	24
Figure 2.9. Dependence of the thermal conductivity of wood, particleboard and fiber board upon specific gravity (from Kollmann, 1956)	26
Figure 2.10. Oven-dry specific heat of wood and wood composite materials, from Gammon, (1987)	28
Figure 2.11. The effect of temperature on the specific heat	29
Figure 2.12. Diffusivity perpendicular to the grain as influenced by density and moisture content (from Kollmann, 1968)	30
Figure 3.1. (a) Setup used to derive thermal diffusivity (b) Setup used to derive conductivity and specific heat (using the results of Method I	33
Figure 3.2. Schematic of the experimental system	35
Figure 3.3. The use of stops for thickness control	37
Figure 3.4. Sample preparation using a "wet formation" method	39
Figure 3.5. Moisture adsorption test for fiber specimens in conditioning rooms	40
Figure 4.1. Boundary conditions for Method I	43

Figure 4.2. Typical experimental curves with error minimized theoretical curve superimposed	45
Figure 4.3. Typical error curve	45
Figure 4.4. Typical experimental record when pressing a pair of fiber disks for method I	46
Figure 4.5. Experimental time-temperature curves for the range of investigated density and moisture content values a. MC = 0 b. MC = 4.7 % c. MC = 8.9 % d. MC = 15.8%	48
Figure 4.6. Experimentally derived diffusivity values plotted against density	50
Figure 4.7. Regression results after taking the logarithm of density and the logarithm of diffusivity a. MC = 0 b. MC = 4.7 % c. MC = 8.9 % d. MC = 15.8 %	51
Figure 4.8. Boundary conditions for Method II	55
Figure 4.9. Typical experimental record when pressing a pair of fiber disks with plexiglas interposed for Method II	58
Figure 4.10. Experimental time-temperature curves for the range of density and moisture content values investigated (with plexiglas) a. MC = 0 b. MC = 4.7 % c. MC = 8.9 % d. MC = 15.8 %	59
Figure 4.11. Experimentally derived conductivity values plotted against density based on regressed diffusivity	62
Figure 4.12. Experimentally derived conductivity value plotted against density	62
Figure 4.13. Regression of thermal conductivity (derived from regressed diffusivity) on density a. MC = 0 b. MC = 4.7 % c. MC = 8.9 % d. MC = 15.8 %	65
Figure 4.14. Regression of thermal conductivity on density a. MC = 0 b. MC = 4.7 % c. MC = 8.9 % d. MC = 15.8 %	66
Figure 5.1. Vapor pressure variation with time after closure for different temperatures (from Bolton and Humphrey, 1989)	71
Figure 5.2. Linear relationship between density and diffusivity after logarithmic transformation	73
Figure 5.3. Derived density-diffusivity relationship	74
Figure 5.4. Effects of moisture on thermal diffusivity	75
Figure 5.5. Derived linear relationship between thermal	

Figure 5.6. Comparison of derived thermal conductivity of wood fiber with that of other published data	78
Figure 5.7. Effects of moisture on derived specific heat values	79

LIST OF TABLES

Table 2.1	The oven-dry specific heat values (from Gammon, 1987)	28
Table 3.1	Essential experimental parameters	41
Table 4.1	Essential experimental parameters 4 moisture content (from Kollmann, 1968)	47
Table 4.2	Combined results of thermal diffusivity measurements	49
Table 4.3	Regression equations and corresponding R^2 values for the effect of density on thermal diffusivity	52
Table 4.4	Thermal diffusivity values obtained for the range of test conditions employed - based on regression analysis	52
Table 4.5	Final derived thermal diffusivity values	53
Table 4.6	Combined thermal conductivity values ($W/m \cdot ^\circ C$) based on regressed diffusivity (α) values	60
Table 4.7	Conversion Results of Thermal Conductivity ($W/m \cdot ^\circ C$)	61
Table 4.8	Regression results for the effect of fiber density on thermal conductivity (based on regressed α) ($W/m \cdot ^\circ C$)	63
Table 4.9	Regressions of the Thermal Conductivity of Wood Fibers on Density ($W/m \cdot ^\circ C$)	63
Table 4.10	Regression Results of Thermal Conductivity ($W/m \cdot ^\circ C$) based on regression diffusivity	64
Table 4.11	Regression Results of Thermal Conductivity ($W /m \cdot ^\circ C$)	64

THERMAL PROPERTIES OF WOOD FIBER NETWORKS

CHAPTER I

INTRODUCTION

Today, most sectors of the wood-based panel products industry show sustained growth. Many new products have been developed since the 1960's, such as medium density fiber board (MDF), wafer board, oriented strand board (OSB) and some cement bonded boards. The pressing operation is one of the most important and expensive in the manufacture of these products. A quantitative understanding of it is important if we are to improve the performance of existing products, to reduce pressing times, and to design processes for the manufacture of new products with specified properties (Humphrey, 1989). The modeling of hot-pressing relies on a rigorous understanding of many interactive physical processes, one of which is conductive heat transfer. The thermal conductivity and specific heat of furnished materials used in the composite materials, and the effects that density and moisture content have on these parameters, are important factors in numerical modelling of the pressing process.

Heat transfer is one of the main physical processes which is involved in hot pressing. During composite manufacture, heat energy is transferred from hot platens to the composite both by conduction and by convection of water vapor (following phase change). At high temperature and in the presence of moisture, wood materials become soft and are easily compacted by pressing pressure to form high density board. In the meantime, the adhesive is cured to achieve a strong internal bond

strength. Therefore, fundamental study of heat transfer is directly related to research on composite manufacture and the final mechanical properties of wood composite materials. The magnitude of heat transfer affects hot pressing time, heat energy consumption and hence production efficiency. In order to be able to model heat and moisture transfer in the hot pressing operation, the data on conduction (thermal conductivity) is needed. Measurement of these properties is the subject of this thesis.

Up to now, most information on the thermal conductivity of insulating materials like wood and wood based composites have been obtained through the use of steady-state plate methods. The specific heat of these materials has been measured by calorimetric methods. Although useful information has been collected, the complicated control system needed to create the necessary boundary conditions, plus the long time required for each test, has limited the amount of data collected. Furthermore, moisture migration when testing hygroscopic materials has led to inaccuracies. Many of the difficulties of the steady-state method may be overcome by the use of unsteady-state or dynamic approaches, and this is what has been done in the present work.

Several efforts were made during the 1950's to measure the thermal properties of wood using unsteady-state methods. An approach which permits the simultaneous determination of thermal conductivity and specific heat was introduced in 1960's. This greatly reduced experiment time, and the relationship between temperature and thermal conductivity as well as specific heat was explored. The reliability of this method was limited by the accuracy of boundary condition control and the

equipment was rather complicated; it has, therefore, been used little.

Today, because of improved computer control, data collection and instrumentation, it has become possible to design various unsteady-state methods for measuring the thermal parameters of hygroscopic insulators efficiently and accurately.

The purposes of this research are:

a. To develop an unsteady-steady state experimental method with simple boundary conditions and apparatus which may be used to determine the thermal conductivity, specific heat and diffusivity of wood fiber or flake mats. Such a method must be fast (to avoid significant moisture migration) and enable the effect of mat density (compression) to be studied.

b. Use the above method to investigate a wide range of mat density and moisture content combinations to determine the thermal parameters under each combined condition. Based on the experimental data, to derive mathematical expressions which relate thermal diffusivity (α) and thermal conductivity (K) of wood fiber mats to their density and moisture content.

c. The boundary conditions created in this investigation are similar, on a small scale, to those that apply during actual commercial hot pressing operations. Some discussions about the effects of platen temperature, pressure, moisture movement and density profile on the test will therefore be included.

CHAPTER II

LITERATURE REVIEW

2.1 Introduction to Heat Transfer

There are three distinct mechanisms of heat transfer: conduction, which is the transfer of heat through rigid material; convection, which results in the transfer of heat between relatively hot and cold portions of a fluid by mixing; and radiation, which involves the transfer of electromagnetic energy in the absence of a conveying medium.

Wood is a porous and hygroscopic material consisting of a combination of solid substance (cell wall) and air pockets (voids). Therefore, heat may flow in wood by all of the above mechanisms acting simultaneously. Heat transfer through solid is by conduction. Heat transfer through the voids of moist wood is essentially by vapor convection, especially at relatively high temperatures. Radiation may only play a significant role when heat is transferred through the voids of dry materials under extreme conditions. Wood and wood based materials, then, offer resistance to heat flow because of the small air pockets in them, as well as the resistance of the wood substance itself to heat transfer (Lawie, 1967).

It is very important to be aware of the confluence of the various mechanisms of heat transfer because, in practice, when one mechanism dominates, approximate solutions are obtained by neglecting all but the dominant mechanism. However, a change of external conditions will often require that one or both of the previously neglected mechanisms be taken into account. For example, when wood and wood based composites are used

as building materials in the atmosphere, heat flows mainly by conduction. When pressing wood-based composites, both conduction and convection (even radiation) become significant. The present work is primarily concerned with conductive heat transfer and the following discussion will consider this. Other studies are directed towards the aspects of phase change and permeation in the system.

2.2 Conductive Heat Transfer

2.2.1. Thermal Conductivity

Conduction is a process by which heat flows from a region of higher temperature to a region of lower temperature within a medium (solid, liquid, or gas) or between different mediums in direct physical contact. In conductive heat flow, the energy is transmitted by direct molecular communication without appreciable permanent displacement of the molecules.

In the solution of heat conduction problems, it is necessary to determine whether a process is of the steady- or unsteady-state type. When the rate of heat flow in a system does not vary with time, the temperature at any point does not change and steady-state conditions prevail. Under steady-state conditions, the rate of heat input at any point of the system must be exactly equal to the rate of heat loss, and no change in internal energy can take place (Frank, 1958). It often takes a long time for a system to attain such a steady-state condition. When the temperatures at various points in a system change with time, the heat flow is transient, or unsteady. Such heat flow problems are encountered during warm-up or cool-down periods.

The basic law of heat conduction was established by Fourier. It is presented as:

$$q = - K \cdot A \frac{dT}{dx} \quad 2.1$$

where q — rate of heat flow
 K — thermal conductivity of the material
 A — the area of the section through which heat flows
(perpendicular to the direction of heat flow)
 dT/dx — temperature gradient at the section

The thermal conductivity (K) is the energy (Q) per unit time (t) which flows through a thickness (x) of a substance with a surface area (A) under a steady-state temperature difference between faces of T_1 and T_2 (Kollmann, 1968). Equation 2.1 provides a definition of thermal conductivity, K .

Thermal conductivity may be expressed in the following units:

1. International Standard (SI) — watts per meter per degree Centigrade ($W./m.^{\circ}C$)
2. British units — B.t.u.'s per square foot per hour per degree Fahrenheit per inch of thickness ($Btu.in./ft^2.hr.^{\circ}F$)
3. c.g.s. units — Calories per centimeter per second per degree Centigrade. ($cal./cm.sec.^{\circ}C$)

The SI system will be used throughout this work.

2.2.2. Specific Heat

The specific heat, c , is defined as the quantity of heat required to raise the temperature of unit mass of a substance one degree. If a quantity of heat (Q) is necessary to raise the temperature of a substance with mass m from T_1 to T_2 , specific heat is expressed as:

$$c = \frac{Q}{m \cdot (T_2 - T_1)} \quad 2.2$$

where Q — heat energy (J)
 m — mass (kg)
 T_1, T_2 — temperature ($^{\circ}\text{C}$)

In the SI system of units, specific heat is expressed as $\text{J} \cdot \text{kg}^{-1} \cdot ^{\circ}\text{C}^{-1}$.

The specific heat of most materials is temperature dependent. However, temperature is a variable in the definition of specific heat. Therefore, the true specific heat is defined as:

$$c = \frac{1}{m} \cdot \frac{dQ}{dT} \quad 2.3$$

For solid and liquid substances, the average specific heat C_m between 0° and T° is expressed by the equation:

$$c_m = \frac{1}{T} \int_0^T c \, dT \quad 2.4$$

2.2.3. Thermal Diffusivity

Thermal diffusivity (α) determines the rate of temperature change in a material when it is subjected to a change in ambient temperature (Wangaard, 1969). An analysis of the time-temperature relationship needs a calculation of the diffusivity.

Fourier's heat conduction equation is written as:

$$\frac{dT}{dt} = \alpha \frac{\partial^2 T}{\partial x^2} \quad 2.5$$

where the constant, α , was termed by Kelvin as the thermal diffusivity and is determined by the relation:

$$\alpha = \frac{K}{c \cdot \rho} \quad 2.6$$

where ρ is density. In the SI system of units, thermal diffusivity (α) has the unit m^2/sec .

The change of temperature in a homogeneous isotropic body is expressed according to Fourier by the following partial differential equation:

$$\frac{dT}{dt} = \alpha \left(\frac{\partial^2 T}{\partial x^2} + \frac{\partial^2 T}{\partial y^2} + \frac{\partial^2 T}{\partial z^2} \right) \quad 2.7$$

where α is thermal diffusivity, and t is unit time.

2.3 Methods of Measuring Thermal Properties

2.3.1 Steady-state Methods

Thermal Conductivity

It is apparent from its definition that thermal conductivity must normally be measured by subjecting the material to a temperature gradient. Therefore, measured values are usually expressed for the mean temperature of the materials during testing. For good accuracy relatively large temperature gradients are often used (in the order of 40°C). Since materials of low thermal conductivity can take a long time to reach steady-state conditions, the measurement process may be very time consuming. Furthermore, for hygroscopic materials such delays can lead to a moisture migration, within the specimen (Gammon, 1987).

Most available data on the thermal conductivity of wood were obtained by the plate method (Wangaard 1969), first used by Grober (1910) and subsequently modified through the introduction of a "guard

ring" to eliminate edge losses (Poensgen, 1912). This method was eventually adopted in the development of a standard testing apparatus for insulating materials by the U.S Bureau of Standard (VanDusen, 1920). The standard method given in ASTM C-177 (ASTM, 1980) uses a guarded hot plate to minimize heat loss. This standard recommends that the temperature differences between the hot and cold surfaces be greater than 5 K (degree of Kelvin). For a 17.5 mm thick plate, the recommended temperature difference is about 11 K.

Specific Heat

Dunlap (1912) described a method using the bunsen ice calorimeter. Oven dry wood cylinders just above the boiling point of water were placed in the calorimeter which contained a known volume of ice and water. The calorimeter was packed in ice and held at zero degrees centigrade. Because ice occupies more volume per unit mass than does water, the measurement of volume contraction, caused by the ice melting from the heat given up by the wood, was used as a measure of the heat given up by the wood.

The method used in ASTM C351-61 (ASTM, 1980) involves using an oven-dry sample that is heated in a capsule (1" in diameter and 2" long) to 100°C, and immersed in a flask containing 300 g of distilled water at 20°C. The specific heat of the wood is calculated from the temperature increase of water caused by the heat given up from the wood, which was adjusted for the heat capacity of the calorimeter. The calculated specific heat is the mean of that of the wood over the initial temperature of the sample and the final temperature of the water.

2.3.2. Unsteady-state Methods

The most serious problems encountered in the use of unsteady-state, or transient, methods are usually the production of the desired boundary conditions, the evaluation or prevention of unwanted heat losses, and the calculation of results (Clarke, 1953).

A selection of unsteady-state methods which have been used for measuring thermal parameters of insulating materials such as wood and wood based composites materials are considered in this section.

Vernotte's Method

Vernotte (1937) proposed a method of obtaining the equivalent of a perfect insulator by using a symmetrical arrangement (Figure 2.1.). The boundary conditions (Figure 2.2.) to be satisfied were:

$$\left\{ \begin{array}{ll} dT/dx = 0 & \text{at } x = 0 \\ dT/dx = Q/K & \text{at } x = L \\ T = 0 & \text{at } t = 0 \\ T \rightarrow \infty & \text{as } t \rightarrow \infty \end{array} \right. \quad 2.8$$

At $x = 0$ (the interface between two test specimens), the solution for Fourier's heat flow equation is:

$$T = \frac{FL}{K} \left[\frac{2}{\pi^2} \left(e^{-mt} - \frac{1}{4} e^{-4mt} + \frac{1}{9} e^{-9mt} \dots \dots \right) + \frac{mt}{\pi^2} - \frac{1}{6} \right]$$

where F — flux of heat
 L — thickness of one specimen

$$m = \frac{\pi^2 K}{c\rho L^2}$$

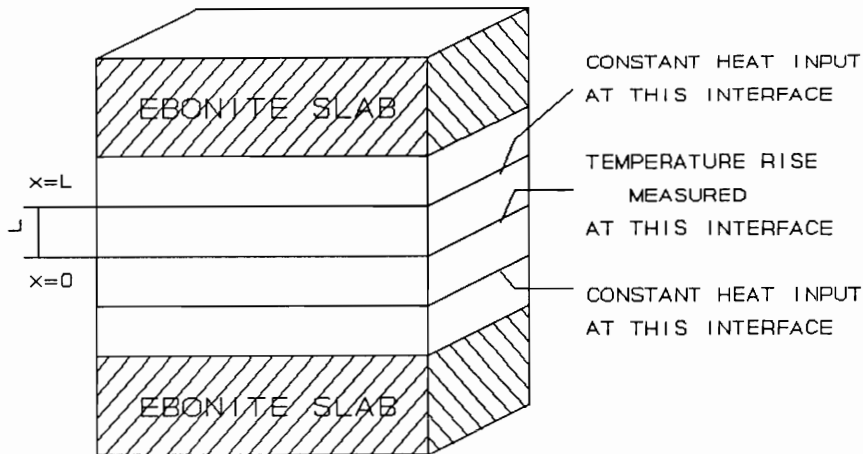

Figure 2.1. Experimental arrangement suggested by Vernotte (Clarke, 1950)

Vernotte's method, reviewed by Clarke (1950), consisted of plotting a theoretical curve of $\log(T) - \text{Log}(FL/K)$ against $\log(mt)$, and fitting to this the curve plotted from test data in the form of $\text{Log}(F)$ against $\text{Log}(t)$. When the curves were fitted, the intercept with the horizontal axis gave $\text{Log}(FL/K)$ and the intercept of the vertical axis gave $\text{Log}(m)$. From $\text{Log}(FL/K)$, K could be found. From $\text{Log}(m)$, and knowing K , c could be found. As L was known, the thermal diffusivity ($K/c \rho$) could be found directly from the value of $\text{Log } m$, even if F was not known. This method did not give very good results because the combination of a small rate of change of curvature of the theoretical curve and a slight scatter of the experimental points made curve fitting difficult. Clarke and Kingston (1950) modified Vernotte's method and developed a new experimental procedure that is set up as shown in Figure 2.2..

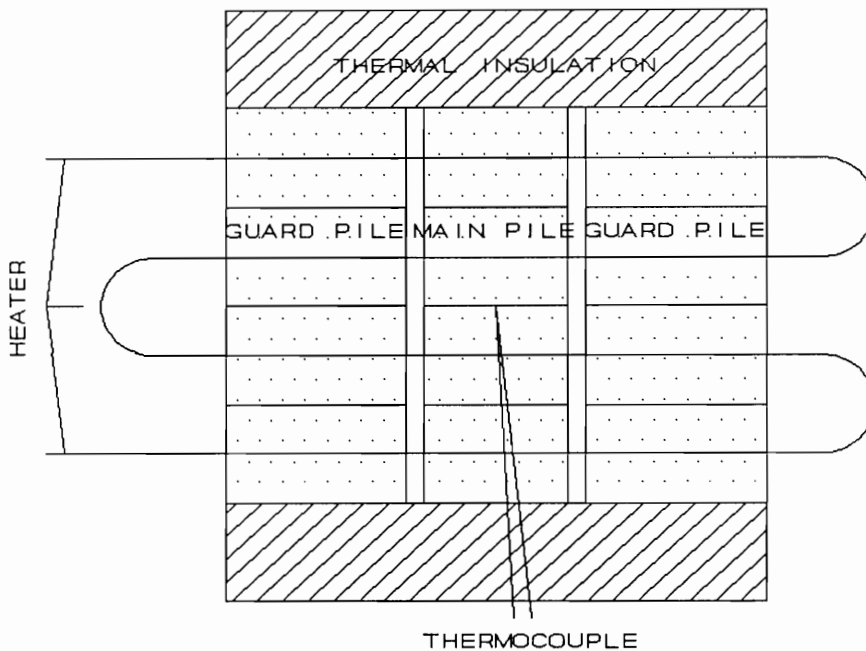

Figure 2.2. Experimental arrangement of piles (Clarke and Kingston, 1950)

The boundary conditions of this method were the same as those of Vernotte (1937). Constant heat input was achieved by passing an electric current through a thin strip of shim steel of the same width as the test blocks. This gave uniform heating across the face of the block and effective thermal contact. Guard piles were used on either side of the main pile to minimize heat loss or gain to the atmosphere. Because the thermal properties of the ebonite or other materials used in the apparatus are comparable with those of the wood being measured, Clarke and Kingston (1950) pointed out that Vernotte's assumption that half of the heat flows towards the thermocouple was erroneous. To eliminate this error, a similar set of heaters and blocks was used outside the existing set to give a further mirror image.

Clarke and Kingston (1950) also suggested a different method of computing the thermal conductivity, K , and specific heat, c . The temperature at the center of the assembly was given by:

$$T = \frac{FL}{K} \left[\frac{2}{\pi^2} \left(e^{-mt} - \frac{1}{4} e^{-4mt} + \frac{1}{9} e^{-9mt} \dots \dots \right) + \frac{mt}{\pi^2} - \frac{1}{6} \right] \quad 2.9$$

Taking two particular times t_1 and t_2 such that $t_2 = 2 \times t_1$, it could be shown that:

$$\begin{aligned} \text{Log } T_2 - \text{Log } T_1 &= \text{Log} \left[\frac{2}{\pi^2} \left(e^{-2mt_1} - \frac{1}{4} e^{-8mt_1} \dots \dots \right) + \frac{2mt_2}{\pi^2} - \frac{1}{6} \right] \\ &- \text{Log} \left[\frac{2}{\pi^2} \left(e^{-mt_1} - \frac{1}{4} e^{-4mt_1} \dots \dots \right) + \frac{mt_1}{\pi^2} - \frac{1}{6} \right] \end{aligned} \quad 2.10$$

The theoretical curves of $\text{Log}(T_2) - \text{Log}(T_1)$ against mt_1 and of $\text{Log}(T_2) - \text{Log}(T_1)$ against $\text{Log}(T_2) - \text{Log}(FL/K)$ were plotted. In the experiment, the temperature T was recorded at a set of times (T_1 values) and at twice these times (T_a values) so that $\text{Log}(T_2) - \text{Log}(T_1)$ could be determined for each particular t_1 . The values of mt_1 and $\text{Log}(T_2) - \text{Log}(FL/K)$ could then be read off the theoretical curves directly. Knowing t_1 , m could be found; knowing T_2 , F and L , K could be determined, and hence, c from the relation $c = K/\alpha\rho$. In this way, a set of values for K and c was obtained.

Parsons (1955) tested Clarke and Kingston's apparatus and found the method suitable to examine the thermal properties of hygroscopic materials. In 15 minute test periods, the temperature gradient across the specimen reached a maximum of $0.2^\circ\text{C}/\text{mm}$. No change in moisture content was detected.

Pratt and Ball (1956) used both a steady-state method and Clark and Kingstong (1950) unsteady-state method on samples of particle board, cork and asbestos board. The close agreement of results led them to the conclusion that the unsteady-state method had practical value.

Clarke's Method

Clarke (1954) developed another unsteady-state method to measure the thermal conductivity of poor conductors over a variable temperature range. The apparatus is illustrated in Figure 2.3.. Clarke's method differs from the standard steady-state method in two ways. First, the temperature of the test samples is continually changed, and second, the rate of heat movement through the sample is obtained by measurement of the temperature rise of a "heat sink" of known heat capacity rather than by direct measurement of electrical power consumption. By this method, therefore, it is possible to continuously evaluate thermal conductivity as a function of temperature in a single experiment (Ward and Skaar, 1963).

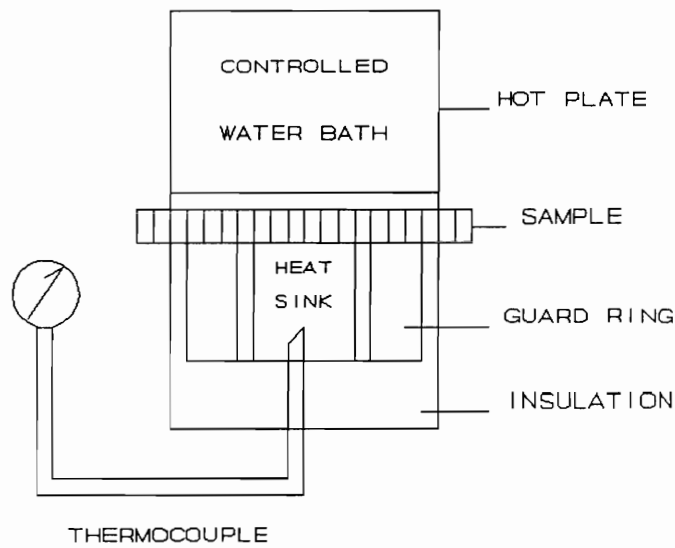

Figure 2.3. Experimental arrangement of transient method (Clark, 1954)

The temperature of A (heat source) was subsequently continuously adjusted so that $(V_a - V_c)$ was constant temperature. The experimental boundary conditions for the experiment may be expressed as follows:

$$\frac{\partial T}{\partial t} = \frac{K}{\rho c} \cdot \frac{\partial^2 V}{\partial x^2}$$

$$T = 0 \quad \text{when } t = 0$$

$$T = V_a \quad \text{at } x = 0 \quad \text{for all } L$$

$$T = V_c \quad \text{at } x = L$$

$$mc' \frac{\partial T}{\partial t} = -K \frac{\partial T}{\partial x} \quad \text{at } x = L \quad 2.11$$

where V — temperature at position x in sample
 x — displacement from A
 L — thickness of sample
 c — specific heat of sample
 K — thermal conductivity of sample
 ρ — density of sample
 m — mass of copper block c per unit area of sample
 c' — specific heat of copper block

The solution of this equation for V_c is given:

$$T_c = \bar{T} \left[\frac{Kt}{L(c\rho L/2 + m)} - \frac{c\rho L/4 + mc'}{6[c\rho L/4 + mc' + (mc')^2/(c\rho L)]} \right. \\ \left. - 2 \sum_{n=1}^{\infty} \frac{e^{-a [Kt/(c\rho L)]}}{[1 + c\rho L/(mc') + (mc'/c\rho L) \cdot a_3^2] \cos a_3 - (1 + c\rho L/(mc'))} \right] \quad 2.12$$

When t is large, the exponential terms vanish and then:

$$\frac{dT}{dt} = \frac{\bar{T}K}{L(c\rho L/2 + mc')} \quad 2.13$$

therefore, the thermal conductivity K is presented as:

$$K = \frac{dT_c}{dt} \cdot \frac{L(mc' + c\rho L/2)}{\bar{T}} \quad 2.14$$

In Clarke's experimental apparatus, the thermal capacity of the heat sink was in the order of 100 times greater than that of the test sample. Thus, even large errors in the assumed value of specific heat for the sample caused only negligible error in the determination of the conductivity K .

Robert and Skaar (1963) described one experimental apparatus which was a modification of Clark's (1954) method (Figure 2.4.).

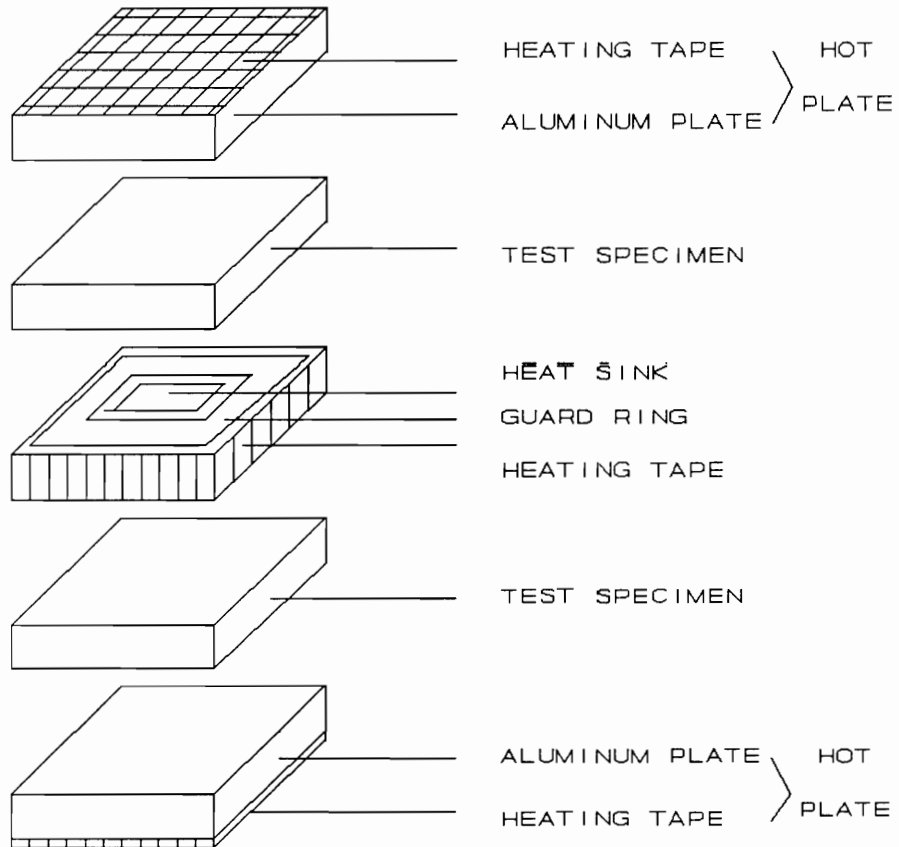

Figure 2.4. Experimental arrangement used by Robert and Skaar (1963)

Two hot plates and samples were used instead of the single units. This dual-sample arrangement doubled the heat capacity of the test sample per unit of thickness and also doubled the area effective for heat conduction. Therefore equation 2.14 was modified to the following form:

$$K = \frac{L}{2T} \cdot \frac{dT}{dt} [c'\rho'L' + c\rho L] \quad 2.15$$

where ρ' — the density of the sink
 L' — the thickness of the sink

A further modification consisted of reducing the heat capacity of the sink to the same order of magnitude as that of the test sample. By making two tests for each sample, each with a different thickness L' of the heat sink, both the conductivity K and the specific heat c could be measured simultaneously.

The apparatus was used continuously to measure the specific heat and thermal conductivity of wood particleboard over a temperature range from -35°C to $+35^{\circ}\text{C}$. The specific heat and the thermal conductivity of particleboard with mean density 700 kg/m^3 and mean moisture content 8.3% were found to increase linearly with temperature. These agree with the results obtained by others on similar types of material. The experiments completed by Robert and Skaar further demonstrated that unsteady-state methods are useful providing short test times and therefore enabling hygroscopic material to be measured.

Nanassy's Method

Nanassy (1978) published a transient method to determine the thermal conductivity and thermal diffusivity of waferboard. Figure 2.5. shows the apparatus. A ring-heater embedded in the center of a specimen of suitable size was electrically heated. Five slabs were held tightly between two metal plates. The temperature of the specimen at the center of the ring-heater was measured with a thermocouple. The temperature rise and its time derivative were recorded by a two-pen chart recorder and used to determine the thermal parameters. The temperature and the

moisture content of the specimen were controlled by placing it in a sealed sample holder.

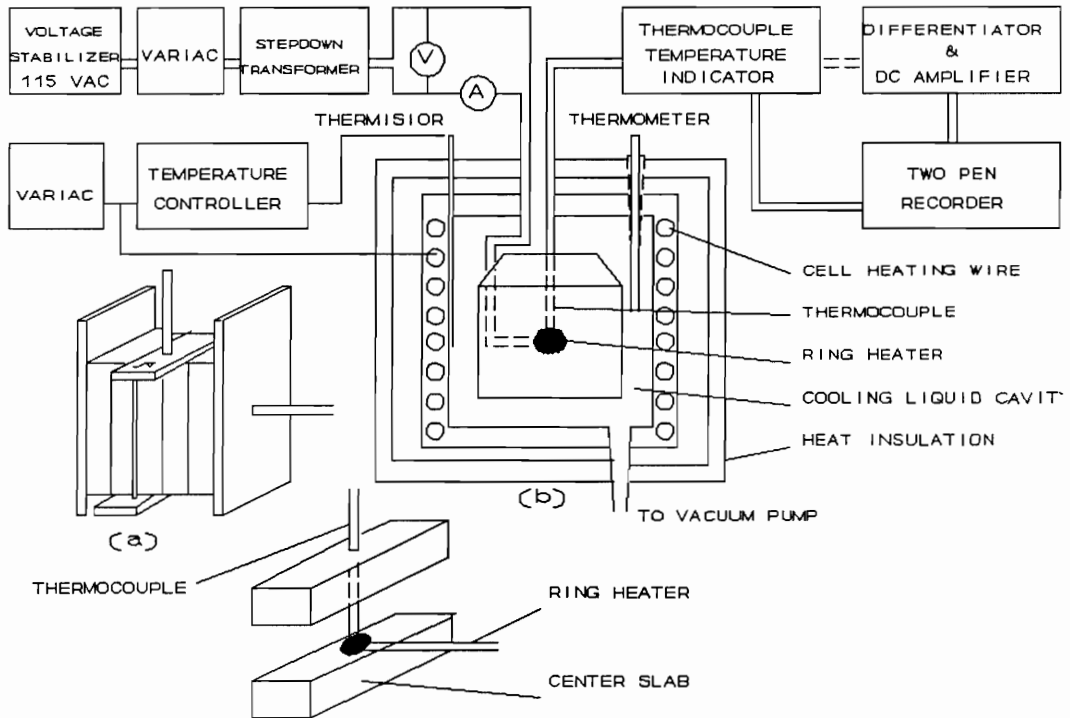

Figure 2.5. (a) Slabs between two metal plates
(b) Experimental arrangement by Nanassy (1978)

The calculation of thermal diffusivity and thermal conductivity was based on the equation of heat diffusion for a point heat source given by Carslaw and Jaeger (1959). This was also valid for the rise of temperature in the center of a ring heat source located in a sufficiently large solid medium. The equation for temperature was:

$$T = \frac{q}{4\pi rK} \operatorname{erfc}\left(\frac{r}{4\alpha t}\right)^{1/2} \quad 2.16$$

where r — radius of ring heater
 q — constant heating rate
 t — heating time
 K — thermal conductivity
 α — thermal diffusivity
 erfc — complementary error function

The first time derivative of equation 2.16 were:

$$T = \frac{q \exp\left(-\frac{r^2}{4\alpha t}\right)}{8K(\pi^3 t^3 \alpha)^{1/2}} \quad 2.17$$

Which had a maximum and the second time derivative was equal to zero, that gave:

$$t_m = r^2 / 6\alpha \quad 2.18$$

or $\alpha = r^2 / 6t_m \quad 2.19$

where t_m was the time required to raise equation 2.17 to a maximum. At the time t_m , equation (2.16) had an inflection, and equation (2.17) had a maximum. Substitution of t_m and α into equation (2.17) gave:

$$K = \frac{0.077 q}{2\pi r t_m T} \quad 2.20$$

According to the t_m value read from the plot (Figure 2.6.) created by the differentiator, thermal diffusivity and thermal conductivity were calculated from (2.19) and (2.20).

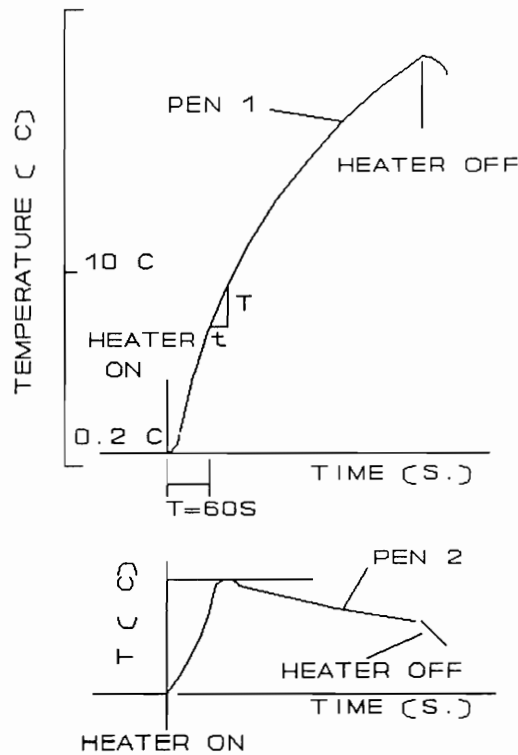

Figure 2.6 Sample chart from waferboard test (from Nanassy, 1978)

Nanassy compared the results obtained with the transient method with those obtained with a steady-state system; she found only slight differences.

2.4. Thermal Properties of Wood and Wood-based Composites

2.4.1. Thermal Conductivity

So far, the thermal conductivity of the wood has been recognized to vary with: 1) density; 2) moisture content; 3) temperature; 4) direction of heat flow with respect to grain; 5) heart wood or sap wood; 6) type and quantity of extractive; 7) the presence of defects (Ward,

1960). A selection of these factors will be considered.

Density and Moisture Effects

The thermal conductivity of wood has been found to be linearly correlated with density (Rowley, 1933; MacLean, 1941; Narayanamurti and Ranganathan, 1941; Thunell and Lundquist, 1945; Kollmann, 1951).

MacLean (1941) derived an equation for oven-dry wood based on English units, which was:

$$K = 1.39 G + 0.165 \quad 2.21$$

This relationship appears to be accurate for all species tested ranging in specific gravity from 0.11 to 0.76 (Kollmann, 1968).

Wangaard (1969) maintained that density appears to be the only variable which significantly affects thermal conductivity.

MacLean (1941) modified equation (2.21) to account for the effect of wood moisture at an average temperature of 25°C.

$$\text{For } mc < 40 \%, \quad K = G (1.39 + 0.028 m) + 0.165 \quad 2.22$$

$$\text{For } mc > 40 \%, \quad K = G (1.39 + 0.038 m) + 0.165 \quad 2.23$$

where G — density based on oven dry weight and volume at moisture content m
 m — moisture content (oven-dry base)
 K — conductivity in Btu.in./hr. ft².°F

Rowley (1933) found thermal conductivity increased linearly with moisture content. However, Kollmann (1951, 1956) found there was no linear relationship existing above 0.8 g/cm³. Kollmann (1968) published a group of data (Figure 2.7.), which showed that at the same density, thermal conductivity increases in proportional to the moisture content.

Maku (1954) used a quadratic formula for the density range from 0.3 to 1.56 g/cm³.

$$K = 0.023 + 0.0842 s + 0.108 s_2$$

2.24

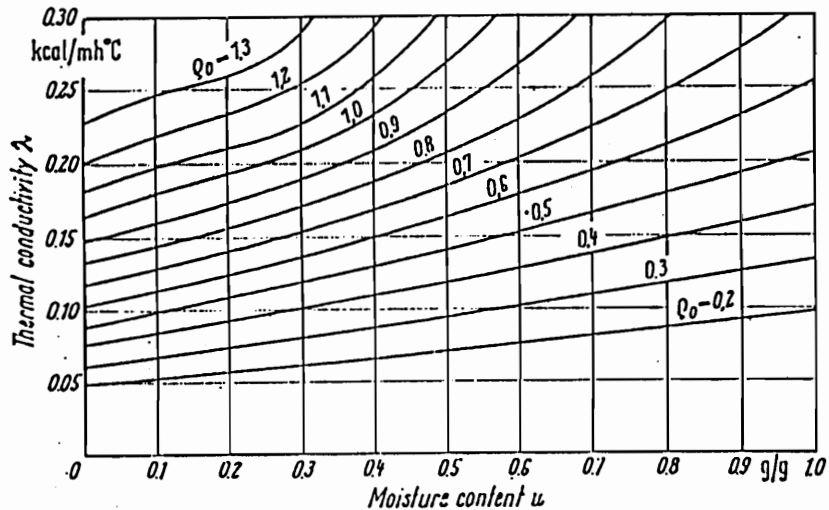

Figure 2.7. Dependence of the thermal conductivity on moisture content of wood (from Kollmann, 1968)

Temperature Effects

Studies of the variation of thermal conductivity with temperature are few. In a review of thermal conductivity literature, Gammon (1987) provided a group of data (Figure 2.8.) for oven-dry wood based on the work of MacLean (1941), Maku (1954), Brown (1973) and Knudson (1979).

For wood with temperatures below 100°C, there was general agreement that thermal conductivity of wood linearly increased with rising temperature.

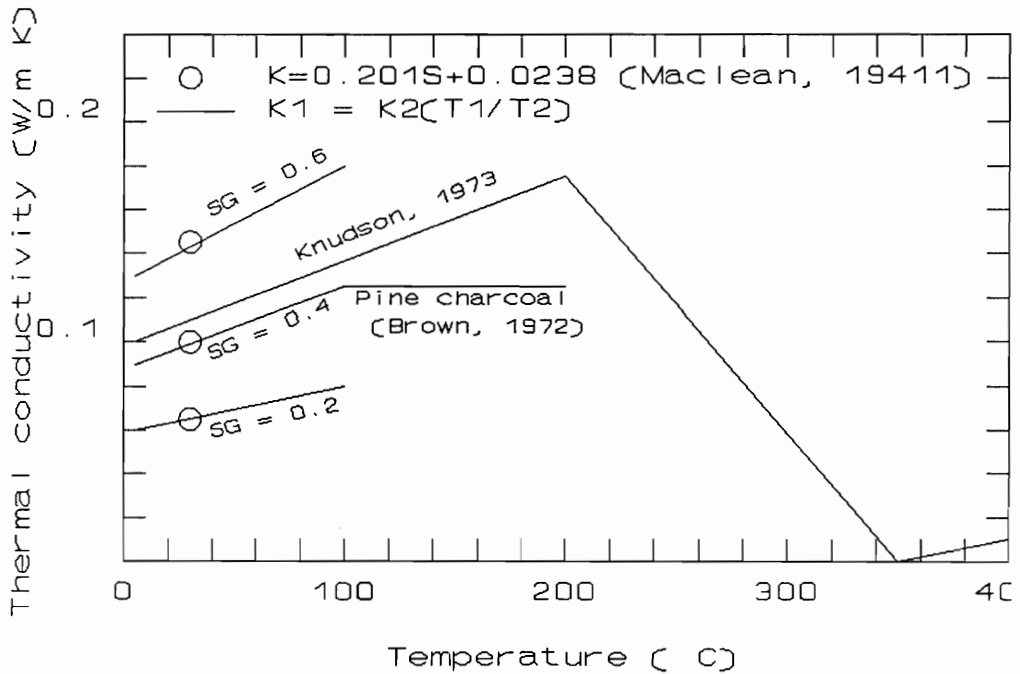

Figure 2.8. Thermal conductivity of oven-dry wood (from Gammon, 1987)

Grain Direction Effects

The thermal conductivity of wood in the radial direction has been found to be about 5 to 10 % greater than in the tangential direction (Griffiths and Kaye, 1923; Wangaard, 1940). Conductivity in the longitudinal direction has been found to be about 2.25 to 2.75 times the conductivity across the grain (Kollmann, 1968) when moisture content

was 6 to 10%.

Kollmann and Malmquist (1956) developed a model to describe the effect of fiber orientation on thermal conductivity. Wood and wood-based composite materials were defined as composing of layers of fiber material and air. Parallel arrangement of the fibers in the direction of heat flow created maximum "heat bridge" effect (K_{max}), and parallel arrangement of the fibers perpendicular to the direction of the heat flow created minimum "heat bridge" effect (K_{min}). The minimum and maximum thermal conductivity could be calculated from layer thicknesses and the conductivity of air and wood cell wall substance. For a body with a mixed arrangement of layers, a weighted average conductivity was obtained by means of the "bridge factor" concept. Therefore, the thermal conductivity of solid wood, particleboard and fiberboard was separated by simply varying the "bridge factor".

Composite Materials

Kollmann and Malmquist (1956) summarized thermal conductivity data from many sources. This showed the dependence of the thermal conductivity of wood, particleboard and fiberboard upon specific gravity. Solid wood had the highest conductivity value, and fiber board the lowest, with plywood being intermediate (Figure 2.9.). Lewis (1967) tested fiber board and particle board and obtained the same results.

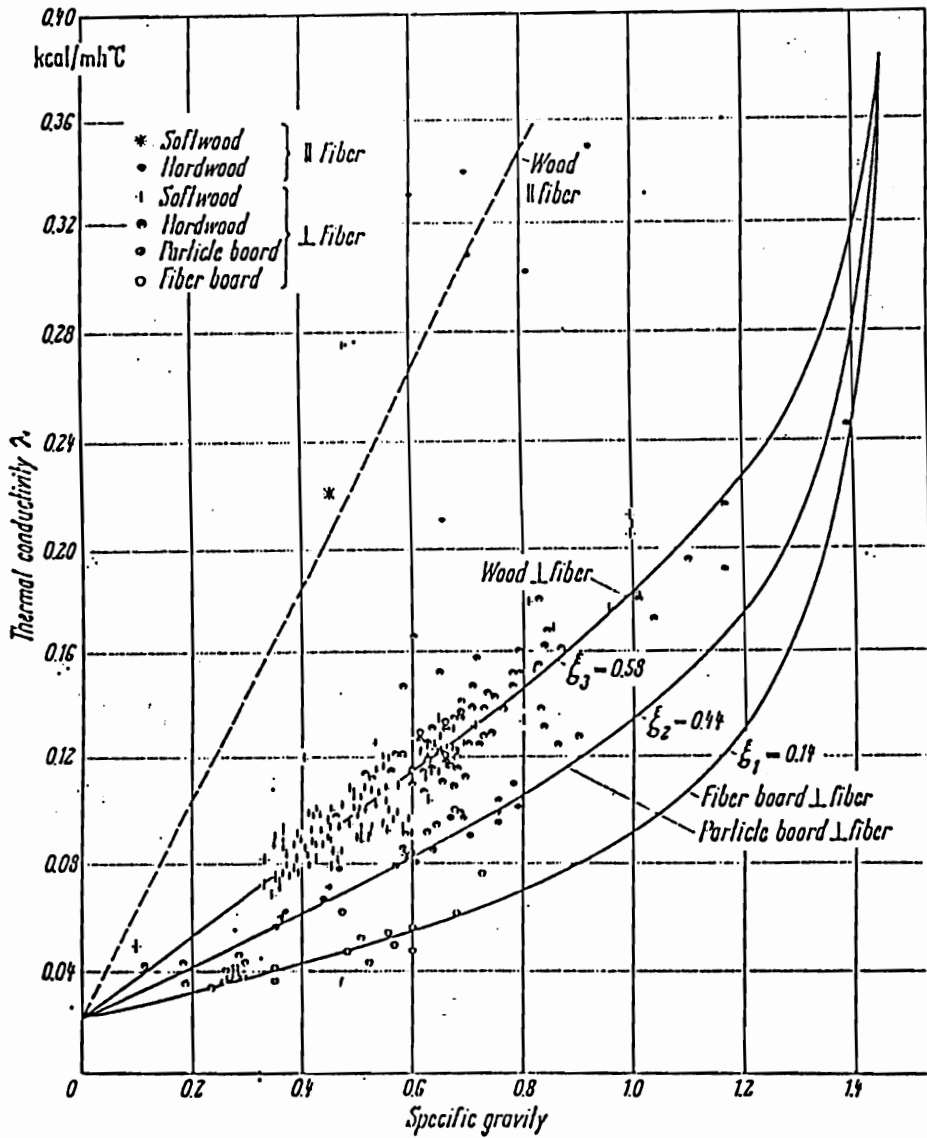

Figure 2.9. Dependence of the thermal conductivity of wood, particleboard and fiberboard upon specific gravity (from Kollmann, 1956)

The thermal conductivity of particleboard varied with temperature (Gilbo, 1951; Kollmann, 1951; Kollmann, 1952; Lewis, 1967; Ward and Skaar 1963). The same is true for wafer board (Nanassy, 1978). There is general agreement that there is a small positive linear effect of temperature on the conductivity value (Humphrey, 1989).

The thermal conductivity of wood-based composites is also affected by moisture content. Since it is difficult to prevent moisture movement in the current test methods, few experimental results have been published. Nanassy (1978) reported that, as would be expected, the thermal conductivity of waferboard increases with an increase in moisture content.

2.4.2. Specific Heat

There is quite a lot information on the specific heat of wood. In tabular (table 2.1.) and graphical (Figure 2.10.) forms, Gammon (1987) summarized the equations for specific heat of oven dry wood and wood-based materials as a function of temperature ranging from -30°C to 140°C . All the equations have showed a linear relationship between specific heat and temperature. The average specific heat determined experimentally by Dunlap (1912) for twenty species between 0°C and 106°C was $0.324 \text{ kcal}\cdot\text{kg}^{-1}\cdot^{\circ}\text{C}^{-1}$, the minimum and maximum values being $0.317 \text{ kcal}\cdot\text{kg}^{-1}\cdot^{\circ}\text{C}^{-1}$ and $0.337 \text{ kcal}\cdot\text{kg}^{-1}\cdot^{\circ}\text{C}^{-1}$ respectively.

Table 2.1. The oven-dry specific heat values (from Gammon, 1987)

Reference	Product ¹	Equation ²	Temperature Range, °C
Dunlap, 1912	---	$c = .266 + .00116T$	0 to 100
Volbehr, 1896	---	$c = .259 + .00121T$	0 to 100
Koch, 1969	1	$c = .265 + .00100T$	60 to 140
McMillin, 196?	1	$c = .271 + .00095T$	-60 to 80
Kuhlmann, 1962	1,2,3	$c = .268 + .00119T$	-40 to 100
Kanter, 1957	---	$c = .37 + .0012 T$	-40 to 100
Geiger, 1942	1,2	$c = .34$ at 12.5 ^{oC}	-25 to 50
Ward & Skarr, 1963	3	$c = .310 + .00202T$	-35 to 35
Nanassy & Szobo, 1978	4	$c = .284 + .00174T$	-30 to 30
Nanassy & Szobo, 1978	5	$c = .279 + .00160T$	-30 to 30

1 Product codes

- 1 = softwood
- 2 = hardwood
- 3 = particle board
- 4 = PF waferboard
- 5 = SSL waferboard

2 c = true specific heat
 T = temperature, °C

Figure 2.10. Oven-dry specific heat of wood and wood composite materials, from Gammon (1987)

The specific heat of wood varied considerably with moisture content (Dunlap, 1912; Kanter, 1957; Kollmann, 1962; Beall, 1968; Steinhagen, 1977;). Kollmann and Cote (1968) assumed a simple additive effect of dry wood and of the water, and derived the following equation:

$$c_u = U + c_o / U + c_w \quad 2.25$$

were c_o — specific heat of oven dry wood (kcal/kg.°C)
 c_w — specific heat of water (kcal.kg-1.C-1)
 U — moisture content (%)

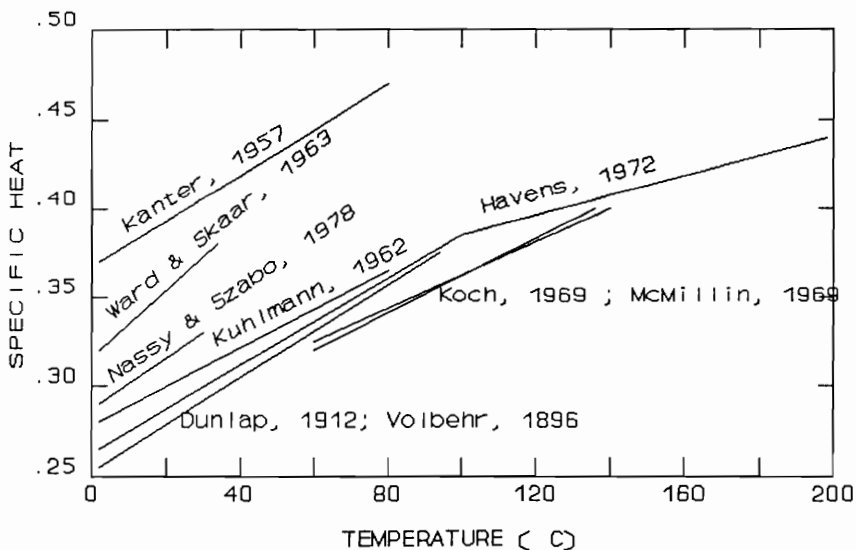
This equation is presented graphically in Figure 2.11..

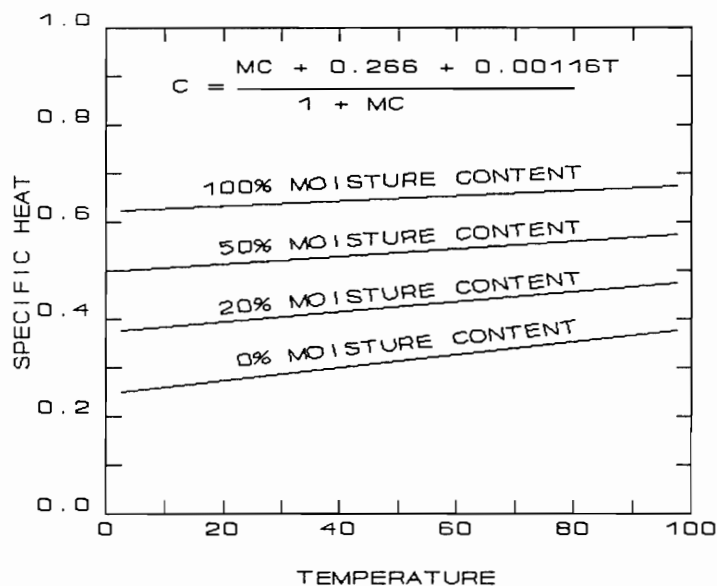

Figure 2.11. The effect of temperature on the specific heat (from McMillin, 1969)

The specific heat was assumed to be independent of species (Dunlap 1912; Kanter, 1957). However, large differences may be present in species with abnormal chemical composition (McMillin, 1969).

2.4.3. Thermal Diffusivity

There are few reports based on direct measurement methods for

thermal diffusivity of wood and wood based materials; available data are calculated from the relation ($\alpha = K/c\rho$). Figure 2.12. showed the influence of density and moisture content on diffusivity (Kollmann, 1968). Wangaard (1969) calculated the diffusivity of southern pine. The reversal of trends showed that diffusivity decreased slightly with increasing density and moisture content (at the same density). MacLean (1930) experimentally determined diffusivity for different timbers of various diameters, and obtained an average of $\alpha = 0.000271$ (in²/sec), or $\alpha = 0.000629$ (m²/hr). Nanassy (1978) measured the diffusivity of waferboard, and found that it increased with temperature and at any particular temperature, it decreased with an increase in moisture content. With density of around 600 kg/m³ the values of 0.120 to 0.113 mm²/s were reported.

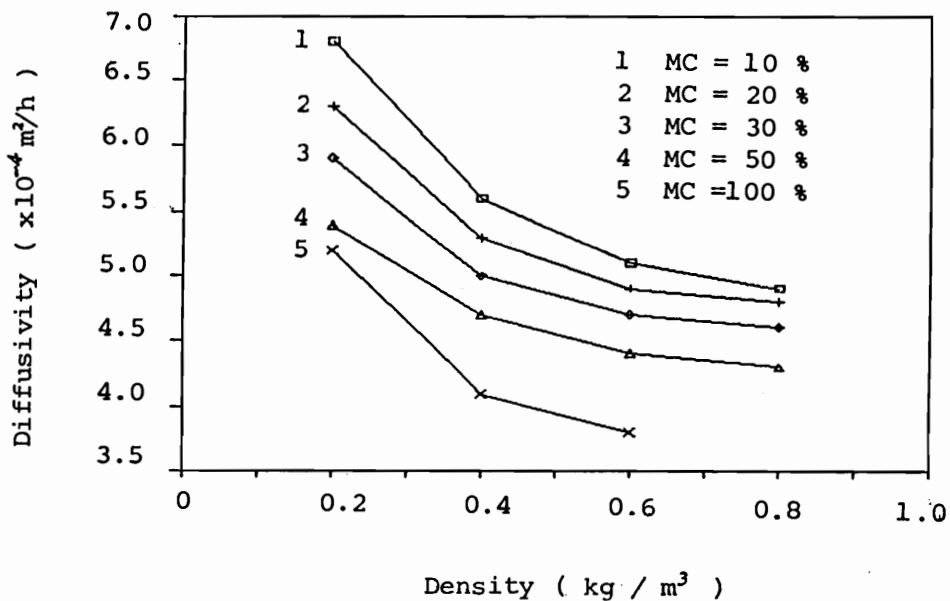

Figure 2.12. Diffusivity perpendicular to the grain as influenced by density and moisture content (from Kollman, 1968)

CHAPTER III

PRINCIPLE OF THE METHOD

3.1. Introduction

The American Society of Testing and Materials standardized a guarded hotplate or steady-state method (ASTM, 1980) to determine the thermal conductivity of wood and wood composite materials.

Disadvantages of this method are that it is time consuming, and that it involves simultaneous measurement of heat flux and temperature gradient through the test sample. For many tests, times in the order of about 8 hours are required to achieve thermal equilibrium. Since no perfectly thermally insulating materials exist, and it is impossible to use a specimen of infinite size, complicated guarding systems are necessary to reduce heat losses. Furthermore, only thermal conductivity may be evaluated with the method. Most importantly in the present application, the generation of a thermal gradient for such a long period in hygroscopic porous materials like wood results in moisture migration. This alters the thermal conductivity of the materials.

In contrast to the steady-state method, unsteady-state or transient methods greatly reduce the time needed to complete a measurement and this, in turn, minimizes moisture migration. In addition, some of these experimental approaches allow thermal conductivity, specific heat and thermal diffusivity to be measured simultaneously. Some of these unsteady-state methods have yielded results comparable with those of the steady-state method (for dry material). However, all of the previous unsteady-state methods do

require either complex equipment or methods in order to create the necessary boundary conditions and minimize heat losses during each test. It is clear from chapter II that these difficulties have limited the acceptance of unsteady-state methods. For many years, little progress has been seen in this area, and few data have been reported.

The purpose of this study was to develop an unsteady-state method with simple experimental apparatus and procedures to determine the thermal conductivity, specific heat and thermal diffusivity of wood composite materials as functions of moisture content and density (degree of compression).

3.2. Underlying Principle of the Method

A thermocouple is placed between a pair of identical cool fiber specimen disks. The top and bottom surfaces of the pair of disks are suddenly heated by the application of two heated metal platens of constant and controlled temperature for about two minutes. The heating curve (time versus temperature) is measured at the interface of the pair of specimen disks (their interface) is measured during this period, and inverse application of the "heat equation" enables the thermal diffusivity of the material to be derived. To obtain the specific heat and thermal conductivity of the material, a second experiment is conducted in which the thermocouple is located in the center of a Plexiglas disk of known thermal properties, which is placed between the wood fiber disks. Using a similar procedure as above, the central temperature rise of the plexiglas disc is recorded. Combining results

obtained with the first experiment (fiber disks compressed without Plexiglas), enables thermal conductivity and specific heat values to be derived. The experimental apparatus is shown in Figure 3.1. (a and b).

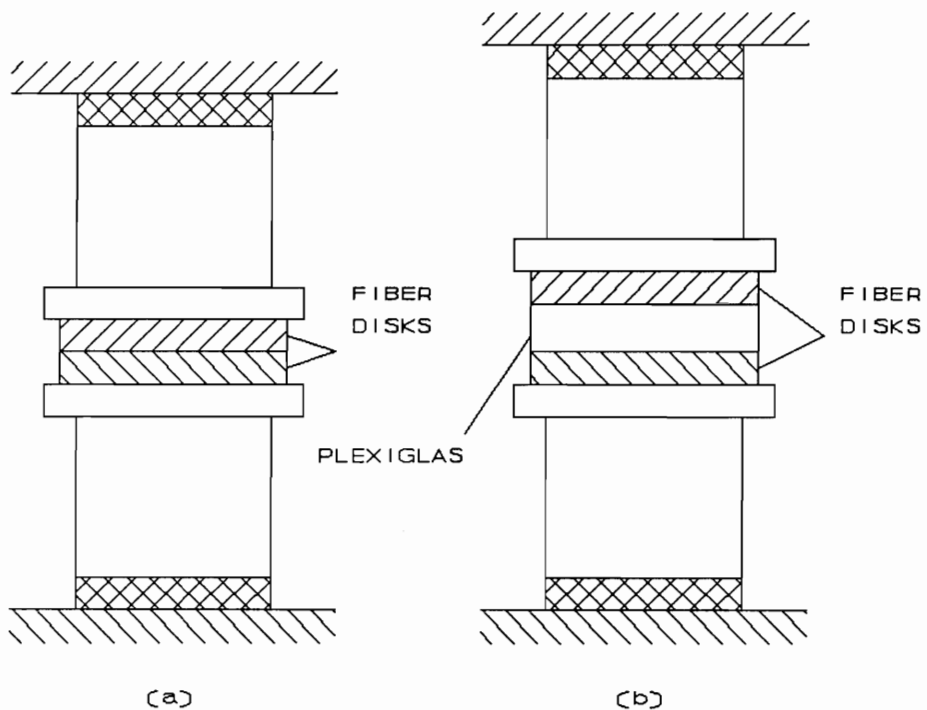

Figure 3.1. (a) Setup used to derive thermal diffusivity

(b) Setup used to derive conductivity and specific (using the results of Method I)

Repetition of this procedure while compressing the fiber disks to different densities (by mounting the apparatus in a universal testing machine) at a range of moisture contents enables the effects of the moisture content and density on thermal properties to be investigated.

The method differs from other unsteady-state methods in four ways:

1. the contact temperature between the heat source and the test specimen is kept constant during the test.
2. relatively large temperature gradients are applied to the test specimens for small times.
3. no special guarding or sealing systems are necessary to prevent heat or moisture loss from the edges of the test specimens.
4. thermal parameters are calculated from a group of experimental data (analogue temperature signal), rather than one or two individual data points.

All these factors reduce the susceptibility of the experimental approach to error.

3.3. Experimental Methods

The experimental apparatus is represented in Figure 3.2.. Design of the apparatus enabled stable heat sources, good thermal contact between heated platens and specimens, accurate platen position control, and accurate measurement of temperature data.

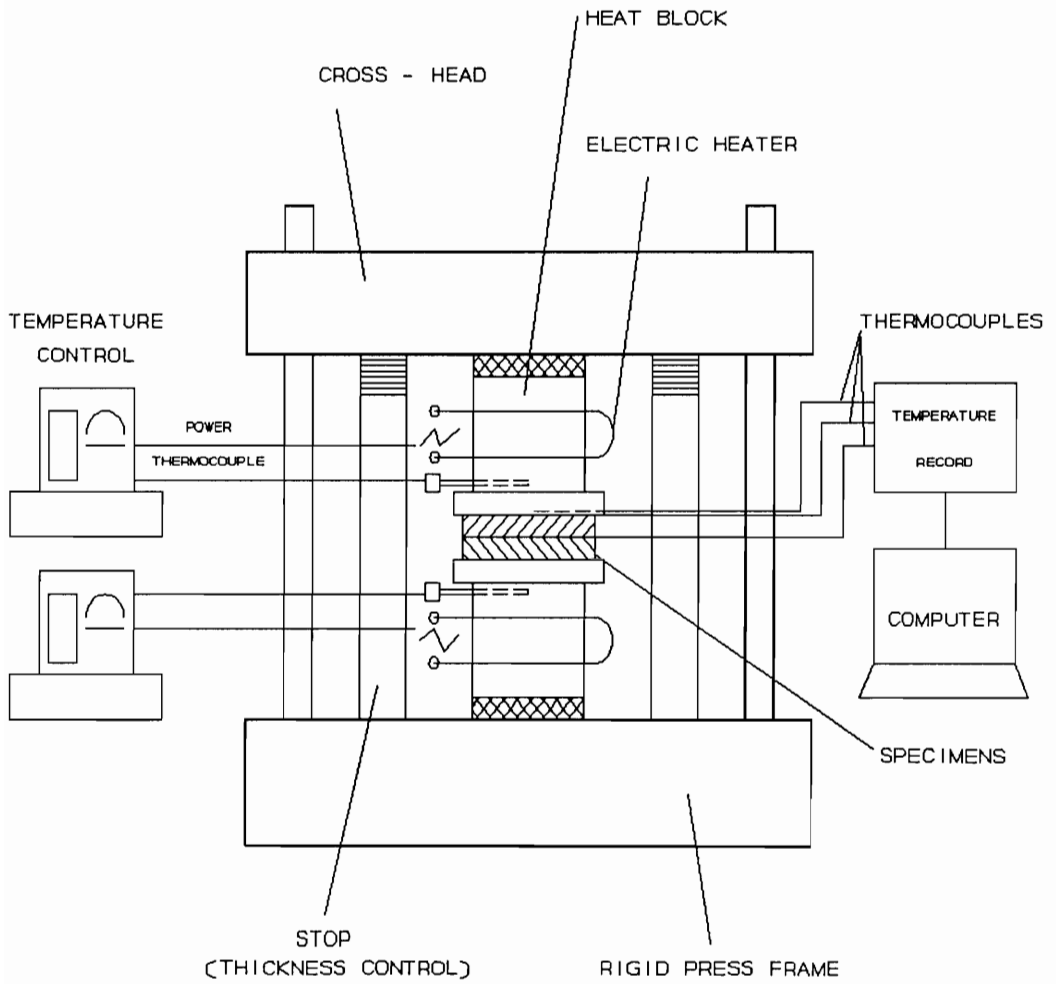

Figure 3.2. Schematic of the experimental system

Temperature control

The heated blocks were designed with sufficient thermal capacity to avoid significant decreases of temperature when the cold wood samples were added; their heat capacity was large compared to that of the wood fiber specimens. Each aluminum block, with a diameter of 150 mm and a height of 125 mm, was heated by an electric band heater fixed around its periphery. A thermocouple was inserted into each aluminum block near the pressing surface, and this was connected to the analog temperature controller. The temperature controllers received millivolt signals from the thermocouples, and provided output electric signals (pulsed 115 VAC) to power the heaters. An accuracy of ± 0.5 °C of temperature in each platen surface was achieved using PID (proportional-integral-differential) control.

Pressing the specimens to achieve target densities

Use of a servohydraulic (MTS) material testing system was initially considered since it offers precise position control by means of a computer. However, the maximum output load of 50 KN provided by the MTS was not sufficient to compress the specimens to the density values required in the experiment. Therefore, a mechanically driven testing machine (Tinius Olsen) with a maximum load of 300 KN was used. Unfortunately, this machine is not well suited to accurate and rapid position control. In the absence of feed-back position control, some pre-made steel stops were used to control the thickness of each test

sample (see Figure 3.3.). Care clearly had to be taken when closing the machine in order to avoid damage to its drive mechanism.

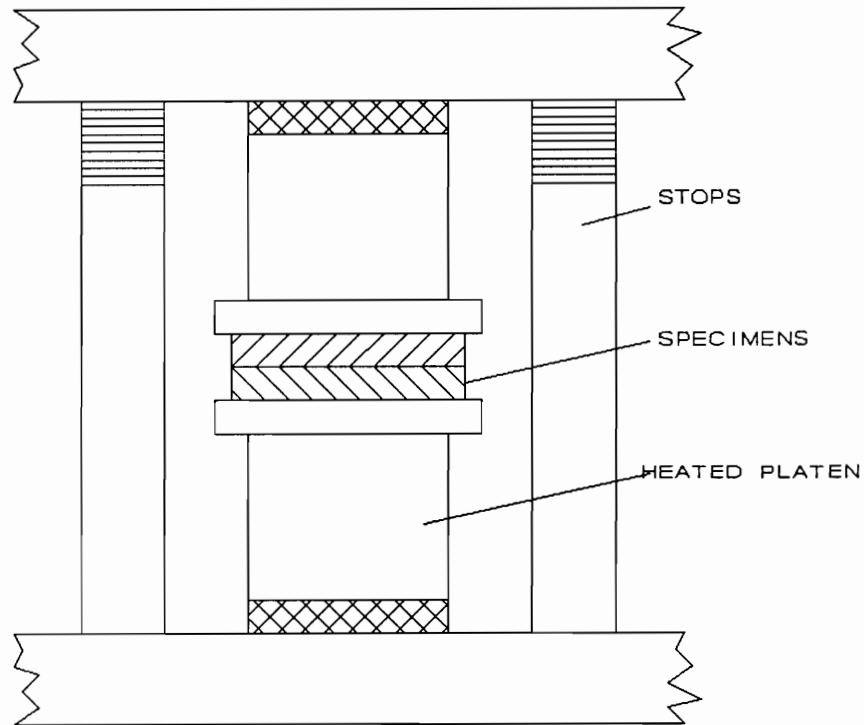

Figure 3.3. The use of stops for thickness control

The degrees of compression employed were sufficient to achieve test densities ranging between 200 and 1000 kg/m³. This range was selected since it encompasses the range of densities likely to occur in composites during their manufacture. Peak compressive loads necessary to realize such compression ranged between 2.64 to 88.2 KN (600 to 20,000 lb). As pressing progressed for each sample pair, compressive resistance decreased and load was transferred to the stops.

Data collection

The data logger (Campbell 21X) and IBM PC data acquisition system with high electronic signal noise rejection were used in this experiment. Three measuring thermocouples were connected to the data logger, which was connected to the computer through an RS232 interface. These were used to monitor the temperature of each heated block and to record the central temperature necessary for deriving thermal properties of the specimens. An acquisition program (Holbo,1988) with 0.5 second dwell time was prepared to collect the data as the experiment proceeded.

Material selection

Red oak (Quescus Rubra) fibers produced by a thermo-mechanical pulping method were used in this research. These were prepared at the USDA Forest Products Laboratory at Madison, Wisconsin. This type of fiber is being used to manufacture "space board" -- a new wood-based composite product recently developed at the Forest Product Laboratory. In order to simulate the hot pressing operation of this product, data for the thermal properties of Red Oak were needed. Having been developed, however, the technique will be used to evaluate a wide range of furnish types.

Test disk formation

Fiber disks measuring 139.7 mm in diameter were formed by means of a wet felt system which was originally designed to make paper handsheet samples (see Figure 3.4.).

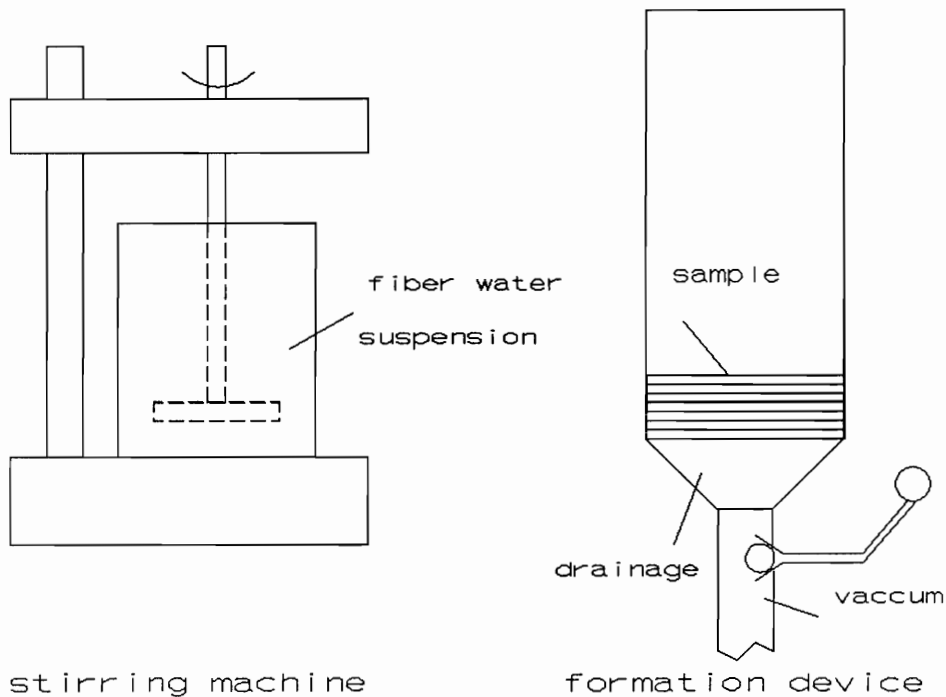

Figure 3.4. Sample preparation using a "wet formation" method

A solution with 2% fiber solids (by weight) concentration was formed by adding 35g of oven-dry fiber into 1750g water. After being stirred at high speed for about three minutes, the fibers were sufficiently separated and uniformly distributed in the solution. Then the solution was put into the sample formation device. Most of the water drained through the screen by gravity. Further water was removed by the application of a vacuum. Because the initial moisture content of the prepared samples was still very high (60% on a oven dry basis), the disks were dried in an oven at 65 °C for several hours until most moisture was driven off.

The dried disks were put in different conditioning rooms in order to attain target equilibrium moisture content values. The ability for

the fiber disks to adsorb moisture (hygroscopicity) under three combinations of temperature and humidity was tested. The test conditions and the results are shown in Figure 3.5.. The disks were placed in the conditioning rooms for extended periods (over two days) in order to ensure that equilibrium had been reached. To avoid hysteresis effects, all samples were conditioned by adsorption.

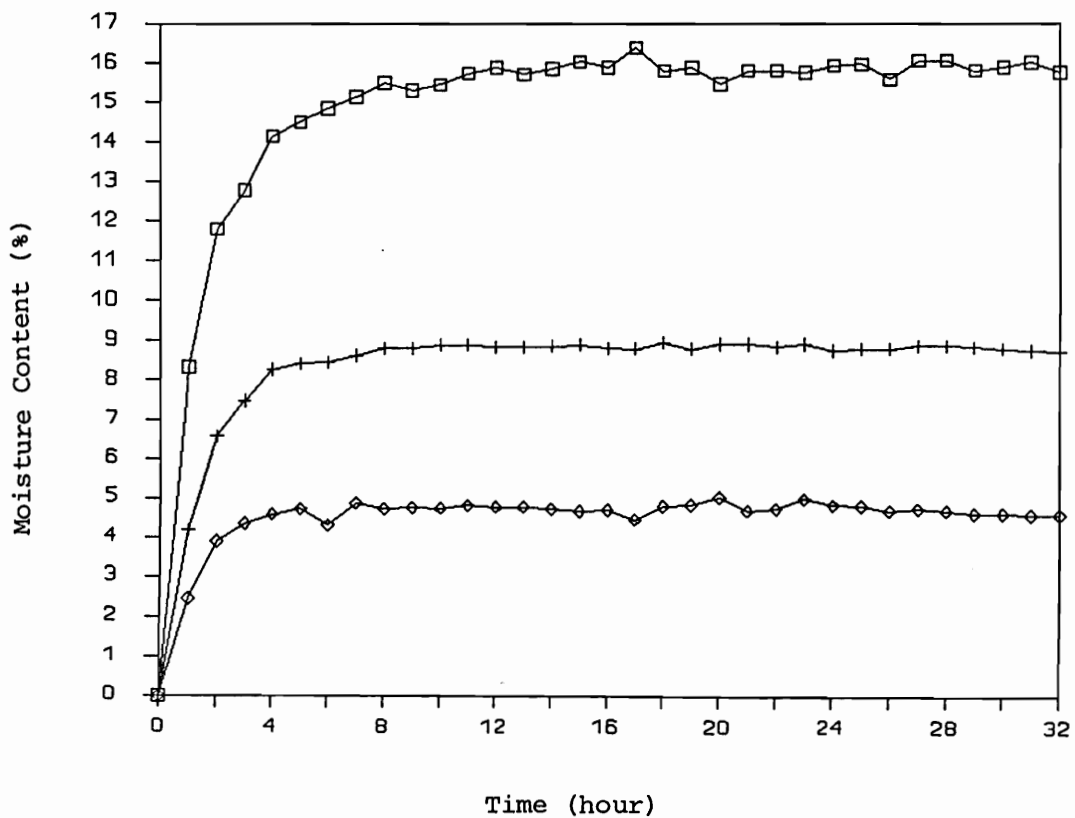

Figure 3.5. Moisture adsorption test for fiber specimens in conditioning rooms

The principal experimental parameters are summarized in table 3.1. below.

Table 3.1. Essential experimental parameters

Wood species	Red wood (<u>Quescus Rubra</u>)
Fiber disk diameter	139.7 mm (before compression)
Fiber disk dry weight	35 g
Close rate (approximate)	2.11 mm/sec.
Plexiglas properties:	
Density	1190 kg/m ³
Conductivity	0.2 W/m.c
Specific heat	1500 J/kg.°C
Platen temperature*	avg. 78°C
Sample mean temperature (before testing)	22°C (for samples at 8.9% M.C.) 30°C (for samples at 4.7% and 15.8% M.C.)
Sample density values	206, 309, 412, 503, 617, 693, 798, 888, 1017 kg/m ³
Sample moisture content	0, 4.7%, 8.9%, 15.8%, (oven dry basis)

* see the discussion in Chapter VI

CHAPTER IV
MATHEMATICAL AND NUMERICAL ANALYSIS

4.1. Determination of thermal diffusivity

4.1.1. Mathematics - Method I

The physical process represented by Figure 3.1.a. can be regarded as one dimensional unsteady-state linear flow problem. Fourier's heat flow equation is:

$$\frac{\partial T}{\partial t} = \alpha \cdot \frac{\partial^2 T}{\partial x^2} \quad 4.1$$

where

- T — temperature of specimen (°C)
- t — time (sec.)
- x — displacement (m)
- α — thermal diffusivity of specimen (m²/sec)
(where $\alpha = K / \rho C$)
- K — thermal conductivity of specimen (W/m°C)
- c — specific heat of specimen (J/kg°C)
- ρ — density of specimen (kg/m³)

The boundary conditions to be satisfied (Figure 4.1.) are:

$$\begin{aligned} \frac{\partial T}{\partial t} &= \alpha \cdot \frac{\partial^2 T}{\partial x^2} & 0 < x < l; \quad t > 0 \\ T(0, t) &= T_0 & 0 < x < L \\ T(0, t) &= T_1 & t > 0 \\ T(L, t) &= T_1 & t > 0 \end{aligned} \quad 4.2$$

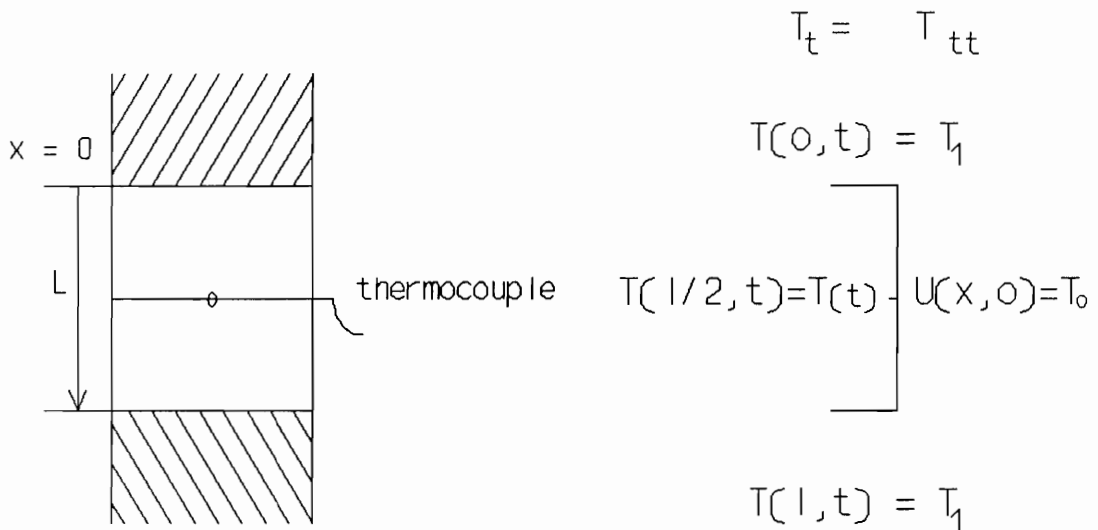

Figure 4.1. Boundary conditions for Method I

The differential equation may be solved by separation variables:

$$T(x, t) = T_1 - \frac{4}{\pi} (T_1 - T_0) \cdot \sum_{n=1}^{\infty} \frac{e^{-(2n-1)^2 (\pi/L)^2 \alpha t}}{2n-1} \cdot \sin \frac{(2n-1)\pi x}{L} \quad 4.3$$

when $x = L/2$, the solution becomes:

$$T(L/2, t) = T_1 - \frac{4}{\pi} (T_1 - T_0) \cdot \sum_{n=1}^{\infty} \frac{(-1)^{n+1} e^{-(2n-1)^2 (\pi/L)^2 \alpha t}}{2n-1} \quad 4.4$$

When the heat conduction equation (4.1) is solved, it is assumed that the diffusivity (a) of the test material is known. The relationship between the heating time and the rising central temperature can be represented by equation 4.4. To obtain the thermal diffusivity of the specimen, a conversion (fitting) approach has been adopted. In other words, this is an inverse problem in which diffusivity is derived by successive approximation; the experimental time-temperature curve can be best fit by one theoretical time-temperature curve generated from one particular thermal diffusivity value, α_x . In order to converge on this value α_x , a series of estimates, $\alpha_1, \alpha_2, \dots \dots \alpha_n$ (covering α_x) were employed. The calculation begins by introducing α_1 into equation 4.4. At every counted moment t_i (2 steps per second, up to 120 seconds), the recorded experimental temperature is compared with the theoretical temperature obtained through equation 4.4 for which an estimated thermal diffusivity value α_1 has been substituted. Accumulated error is derived by summing the error (above difference) which results from each comparison at time t_i (Figure 4.2.). By repeating this procedure with differing thermal diffusivity values (α_2 through α_n), a series of accumulated error values are obtained. When these values are plotted against estimated diffusivity, an error curve is derived which has a minimum at α_x (Figure 4.3.). With this diffusivity value, the experimental curve is best fitted by the theoretical solution of the heat equation.

A computer program has been prepared to perform this error minimization routine. The program presented as in appendix A.

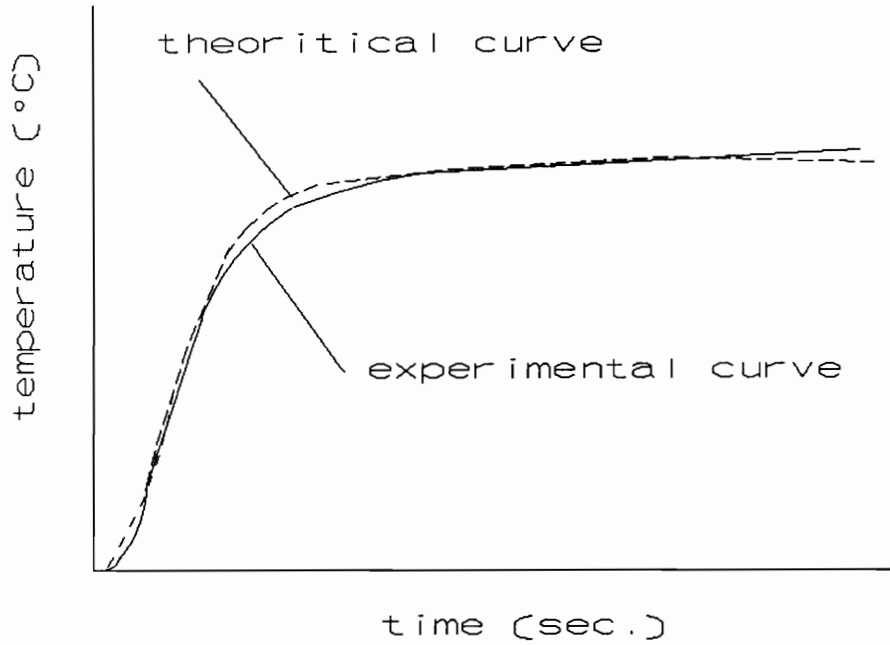

Figure 4.2. Typical experimental curve with error-minimized theoretical curve superimposed

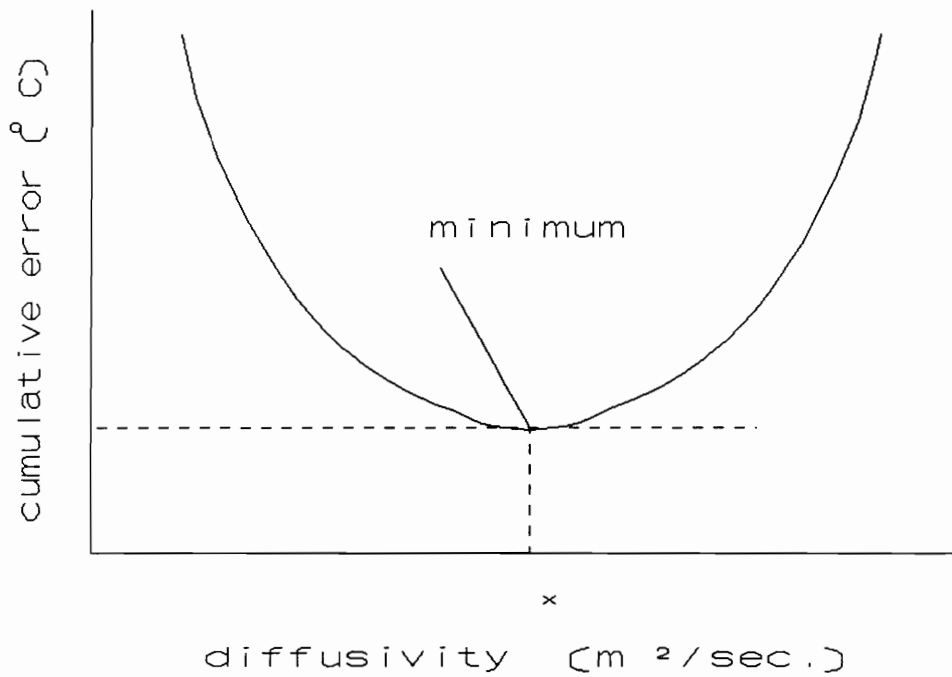

Figure 4.3. Typical error curve

4.1.2. Results of Numerical Analysis for Method I

Figure 4.4. shows a typical experimental record when pressing a pair of fiber disks. This provides the following information: 1) the initiation time ($t=0$) for heat transfer from the metal platen to the fiber disks (upon rapid surface temperature rise), 2) the average platen temperature T_1 (from $t=0$ to $t=120$ sec.) during the testing period, 3) the initial uniformly distributed temperature T_0 , and 4) the rising temperature T_x in the center of the pair of test specimens. For each test, these data were input to the computer program to obtain a converged thermal diffusivity value (α) of the specimen.

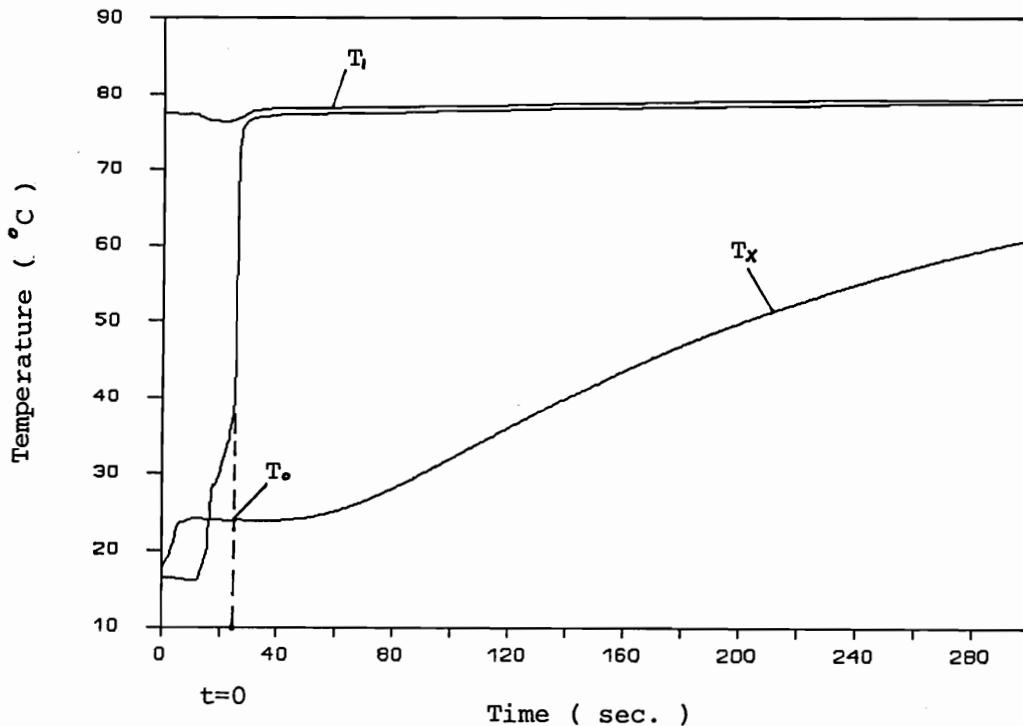
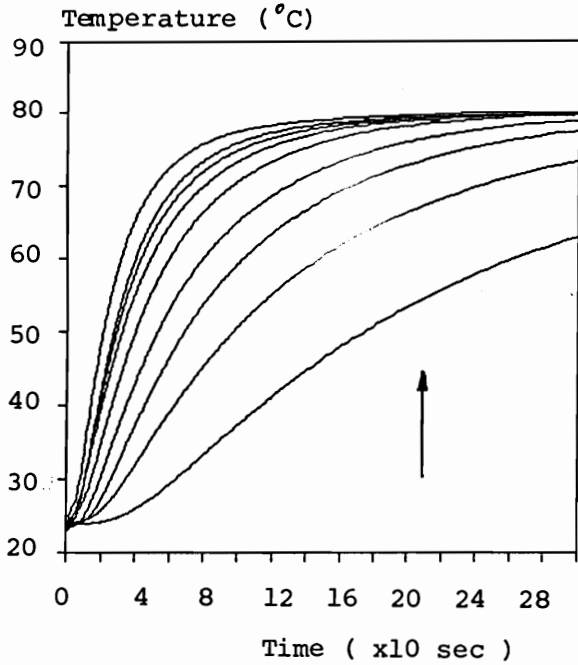

Figure 4.4. Typical experimental record when pressing a pair of fiber disks for Method I

Table 4.1. shows applied experimental conditions. The density of the fiber disks ranged from 205.6 kg/m³ to 1017.1 kg/m³ (nominal densities based on oven-dry density), and the moisture content ranged from 0% to 15.8%. The complete set of temperature versus time curves for the center of all the disk pairs tested in Method I (when heated a mean temperature of 78°C) are presented as Figure 4.5.(a-d).

Table 4.1. The combinations of moisture content and density investigated

DENSITY (kg/m ³)	MOISTURE CONTENT (%)			
	0	4.7	8.9	15.8
205.8	+	+	+	+
308.7	+	+	+	+
411.7	+	+	+	+
502.7	+	+	+	+
617.5	+	+	+	+
693.4	+	+	+	+
797.8	+	+	+	+
888.1	+	+	+	+
1017.1	+	+	+	+



a MC = 0

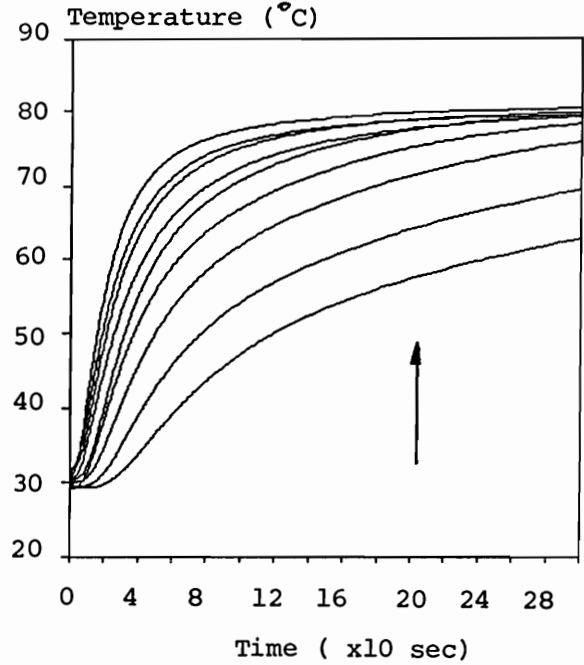

b MC = 4.7 %

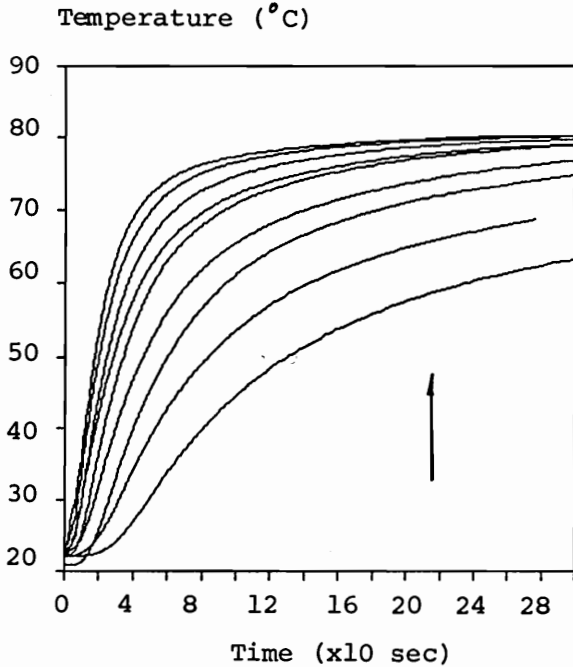

c MC = 8.9 %

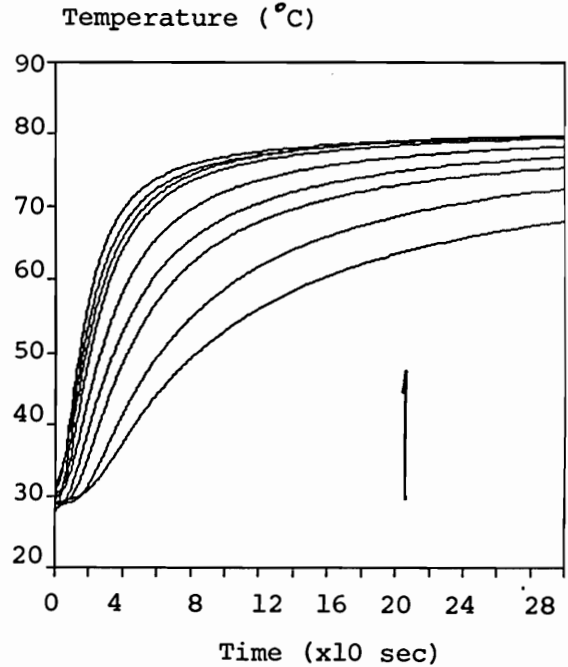

d MC = 15.8 %

↑
 $D = 205.8, 308.7, 411.7, 502.7, 617.5, 693.4, 797.8, 888.1, 1017.1 \text{ kg/m}^3$

Figure 4.5. Experimental time-temperature curves for the range of investigated density and moisture content values

Table 4.2. contains calculated values of thermal diffusivity obtained for the range of densities and moisture contents. It is an objective of this study to derive expressions which relate thermal properties of the fiber disks to density and moisture content. To check the trend of the interrelationship, diffusivity data from Table 4.2. are plotted against density (Figure 4.6.).

Table 4.2. Combined results of thermal diffusivity measurements
($\times 10^{-7} \text{ m}^2/\text{sec.}$)

DENSITY (kg/m^3)	MOISTURE CONTENT (%)			
	0	4.7	8.9	15.8
205.8	1.91	2.63	2.89	3.51
308.7	1.52	1.73	1.88	2.16
411.7	1.20	1.37	1.45	1.72
502.7	1.06	1.18	1.23	1.33
617.5	0.96	1.03	1.14	1.19
693.4	0.89	0.92	0.98	1.04
797.8	0.80	0.88	0.93	1.01
888.1	0.68	0.78	0.85	0.97
1017.1	0.65	0.74	0.80	0.89

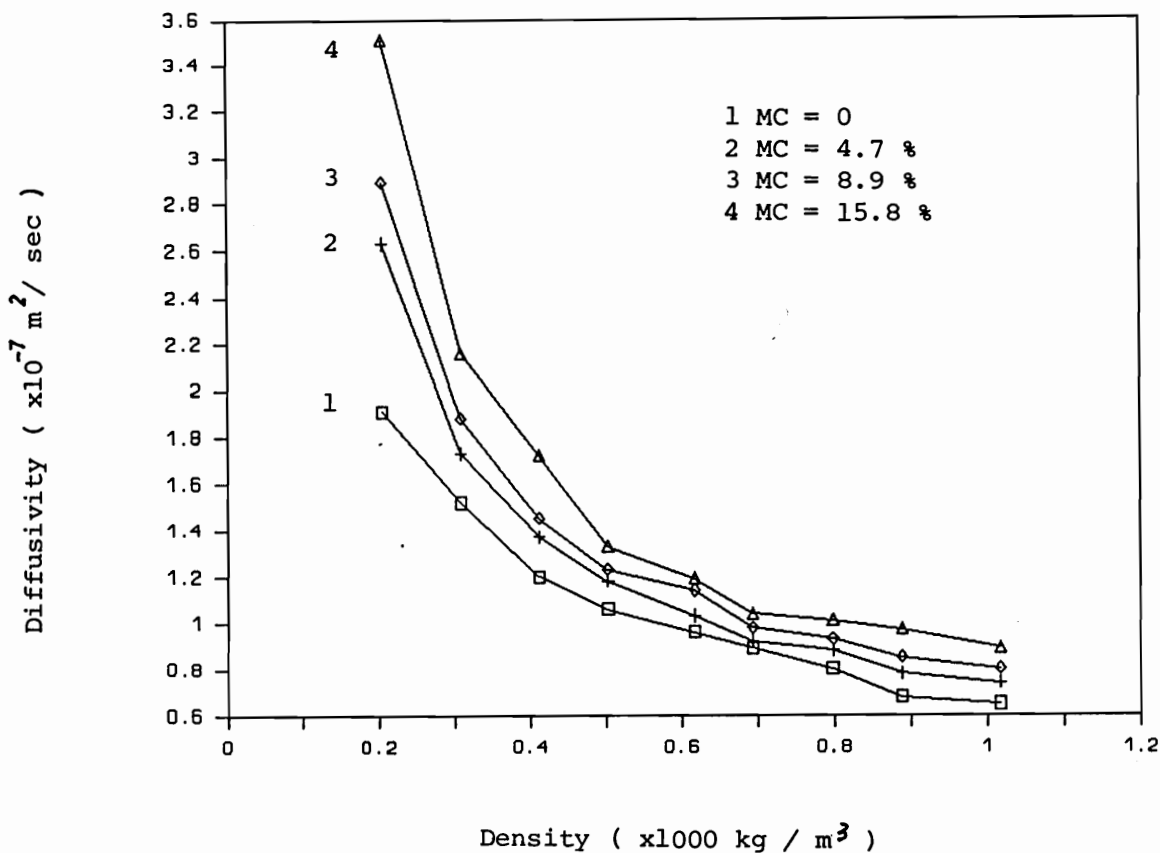

Figure 4.6. Experimentally derived diffusivity values plotted against density

A range of numerical operations were applied to these data, and it was found that taking the logarithm of diffusivity and the logarithm of density yields a linear correlation. Such plots are presented as Figure 4.7.(a - d), while the results of the linear regression are summarized in Table 4.3.. The regressed diffusivity values are given in Table 4.4..

Table 4.3. Regression equations and corresponding R^2 values for the effect of density on thermal diffusivity

MOISTURE CONTENT	REGRESSION FORMULA	R^2
0.0 %	$\log Y = -5.13436 - 0.680391 * \log X$	99.12
4.7 %	$\log Y = -4.80040 - 0.782151 * \log X$	99.01
8.9 %	$\log Y = -4.74932 - 0.789194 * \log X$	98.45
15.8 %	$\log Y = -4.53285 - 0.850613 * \log X$	97.30

Table 4.4. Thermal diffusivity values ($\times 10^7$ m²/sec.) obtained for the range of test conditions employed - based on regression analysis



DENSITY (kg/m ³)	MOISTURE CONTENT (%)			
	0	4.7	8.9	15.8
205.8	1.95	2.45	2.66	3.15
308.7	1.48	1.78	1.93	2.23
411.7	1.22	1.42	1.53	1.75
502.7	1.06	1.22	1.31	1.47
617.5	0.92	1.03	1.11	1.23
693.4	0.85	0.94	1.02	1.12
797.8	0.77	0.85	0.91	0.99
888.1	0.72	0.78	0.83	0.91
1017.1	0.65	0.70	0.75	0.81

According to the regression analysis, the thermal diffusivity values based on the rounded off density values are listed in Table 4.5..

Table 4.5. Final derived thermal diffusivity values
($\times 10^{-7} \text{ m}_2/\text{s}$)

DENSITY (kg/m^3)	MOISTURE CONTENT (%)			
	0	4.7	8.9	15.8
200	1.99	2.52	2.72	3.23
300	1.51	1.82	1.97	2.29
400	1.24	1.46	1.57	1.79
500	1.06	1.22	1.32	1.48
600	0.94	1.06	1.14	1.27
700	0.85	0.94	1.01	1.11
800	0.77	0.84	0.91	0.99
900	0.71	0.77	0.83	0.89
1000	0.66	0.71	0.76	0.82

4.2. Determination of Specific Heat and Thermal Conductivity

4.2.1. Mathematics - Method II

The physical system represented by Figure 3.1.b. is also a one dimensional unsteady-state linear flow problem. Fourier's heat flow equations are:

$$dU / dt = \alpha * (\partial^2 U) / (\partial x^2) \quad 4.5$$

$$dV / dt = b * (\partial^2 V) / (\partial x^2) \quad 4.6$$

where

- t — time
- x — displacement from datum parallel to heat flux direction
- U — temperature of specimen at position x and time t
- α — thermal diffusivity of specimen (where $\alpha = K / C \rho$)
- K — thermal conductivity of specimen
- C — specific heat of specimen
- ρ_s — density of specimen
- V — temperature of plexiglas at position x and time t
- b — thermal diffusivity of plexiglas (where $b = k / c \rho$)
- k — thermal conductivity of plexiglas
- c — specific heat of plexiglas
- ρ — density of plexiglas

The boundary conditions to be satisfied (Figure 4.8.) are:

$$\begin{aligned} dU/dt &= a * \partial^2 U / \partial x^2 & 0 < x < L ; & t > 0 \\ U(0,t) &= T_1 & & t > 0 \\ U(x,0) &= T_0 & 0 < x < L & \\ dV/dt &= b * \partial^2 V / \partial x^2 & L < x < L+M ; & t > 0 \\ V(x,0) &= T_0 & L < x < L+M & \\ dV/dx(L+M,t) &= 0 & L < x < L+M & \\ U(L,t) &= V(L,t) & t = 0 ; & t > 0 \\ K*dU/dt(L,t) &= k*dV/dt(L,t) & & t > 0 \end{aligned} \quad 4.7$$

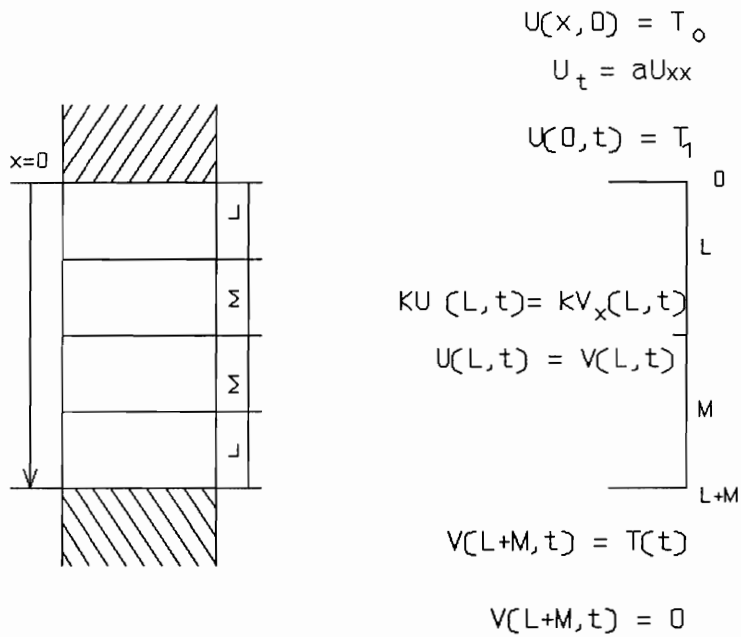

Figure 4.8. Boundary condition for Method II

By considering the boundary conditions at the interface of the two regions, the two differential equations can be solved using the method of variable separation:

$$U(x, t) = T_1 + \sum_{n=1}^{\infty} \left(\epsilon_n \cos \frac{\lambda_M}{\sqrt{b}} \right) e^{-\lambda t} \sin \frac{\lambda x}{\sqrt{\alpha}} \quad 4.8$$

$$V(x, t) = T_1 + \sum_{n=1}^{\infty} \left(\epsilon_n \sin \frac{\lambda_L}{\sqrt{\alpha}} \right) e^{-\lambda t} \cos \frac{\lambda(x-L-M)}{\sqrt{b}} \quad 4.9$$

where λ is the root of the following equation:

$$\frac{\sqrt{b} K}{\sqrt{\alpha} k} = \operatorname{tg} \frac{\lambda_L}{\sqrt{b}} + \frac{\lambda_M}{\sqrt{\alpha}} \quad 4.10$$

ε_p can be solved from the following equation:

$$\varepsilon_p = \frac{2(T_0 - T_1) \frac{c\rho\sqrt{\alpha}}{\lambda_p} \cos \frac{\lambda_p M}{\sqrt{b}}}{c\rho L \cos^2 \frac{\lambda_p M}{\sqrt{b}} + c\rho M \sin^2 \frac{\lambda_p L}{\sqrt{\alpha}}} \quad 4.11$$

Substituting $x = L + M$ into the equation 4.9, the temperature in the center of the plexiglas disk becomes:

$$V(L+M, t) = T_1 + \sum_{n=1}^{\infty} \varepsilon_p \sin \frac{\lambda_n L}{\sqrt{\alpha}} e^{-\lambda t} \quad 4.12$$

Knowing thermal diffusivity of the fiber disk under the prevailing conditions (from method I), together with the specific heat and thermal conductivity of the plexiglas, the relationship between the heating time and the rising temperature in the center of the plexiglas is set up by equation 4.12.. In practice, the thermal conductivity and specific heat of the wood fiber are unknown. An initial estimate of it is made and the required root of equation 4.10 is then obtained using a linear search followed by root-finding by bisection. Substituting equation 4.11 into 4.12, the theoretical temperature versus time curve is finally obtained. This is compared with the experimental curve. By continually

guessing the specific heat values followed by the same inverse procedure described in the previous section Method I, the specific heat of the wood fiber can be obtained. Thermal conductivity may then be derived from the expression:

$$K = \rho C \alpha$$

A computer program has been prepared to perform this error minimization routine, a copy of which is presented in appendix B.

4.2.2. Results of Numerical Analysis

The essential features of the data for Method II are similar to these for Method I. Values for $t = 0$ and T_1 are derived in a similar manner. A typical set of data is, however, given (Figure 4.9.) for Method II since the slower rate of central temperature rise is noteworthy (T_x). Following conditioning, each pair of fiber disks used in Method I were pressed once again under the same density and moisture content corresponding to Table 4.1.. For each test, values for $t = 0$, T_0 and T_x along with the thermal properties of plexiglas ($b, k, c,$), and the fiber specimen diffusivity (α) obtained from Method I were input to the computer program to obtain the specific heat (C) and the thermal conductivity (K) of the fiber specimen. Figure 4.10.(a-d) summarizes the temperature increases at the center of the plexiglas disk for the range of fiber specimen density values. This is for heating at mean temperature of 78 °C.

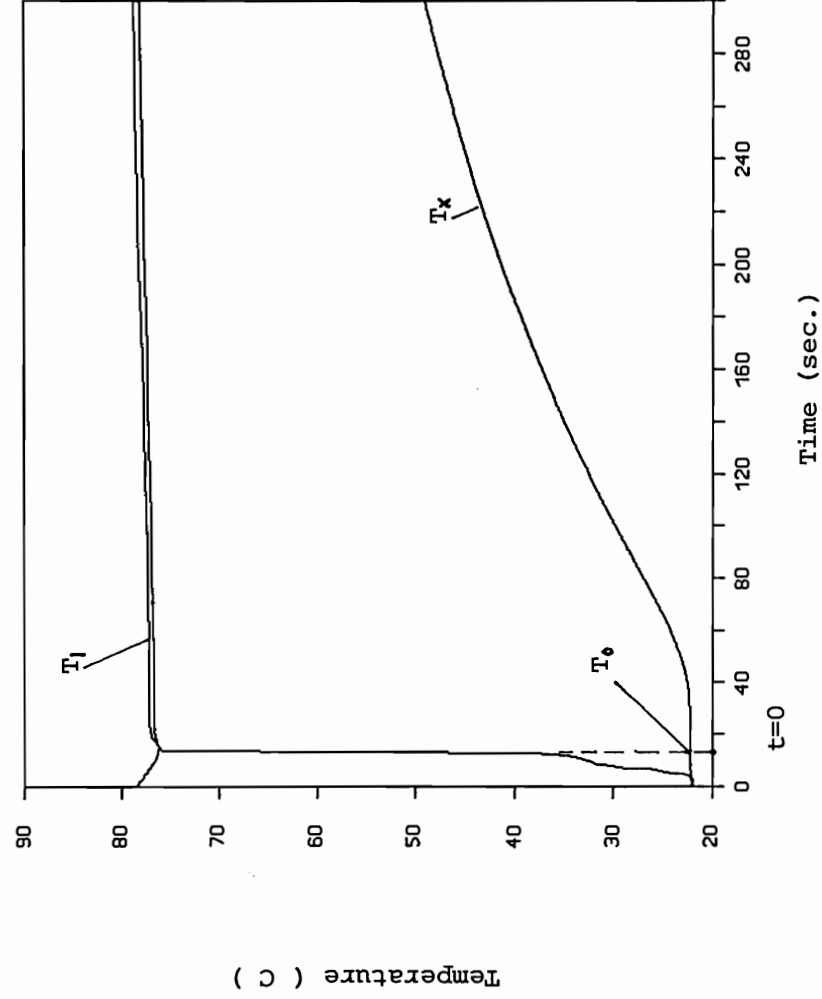
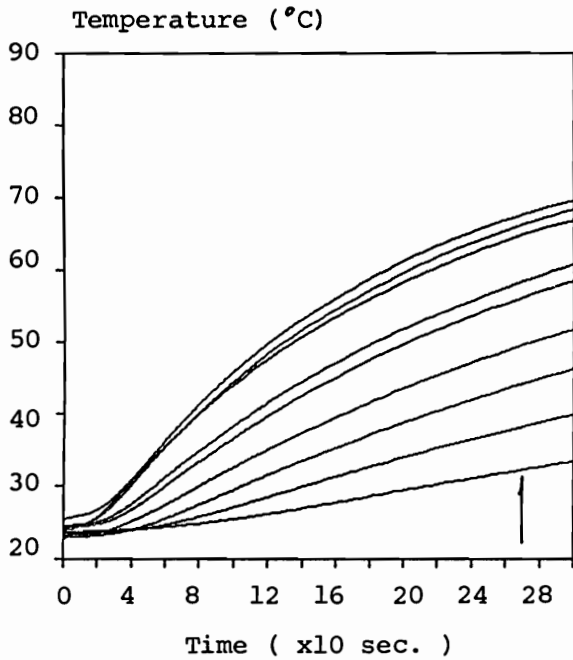
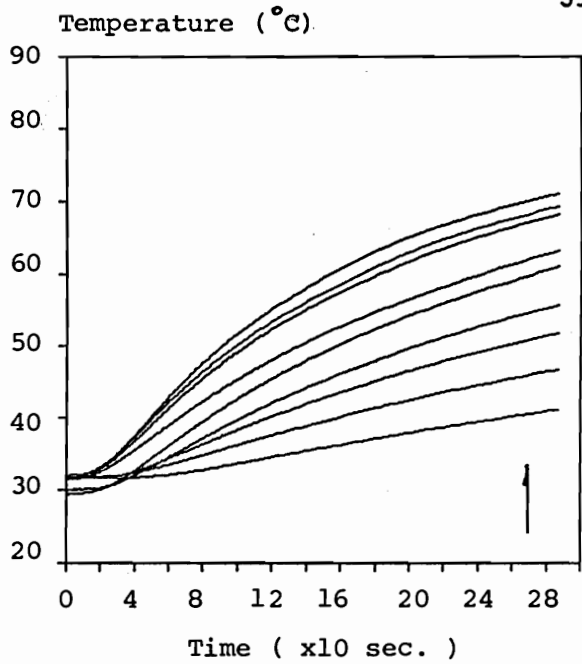

Figure 4.9. Typical experimental record when pressing a pair of fiber disks, for Method II



a MC = 0



b MC = 4.7 %

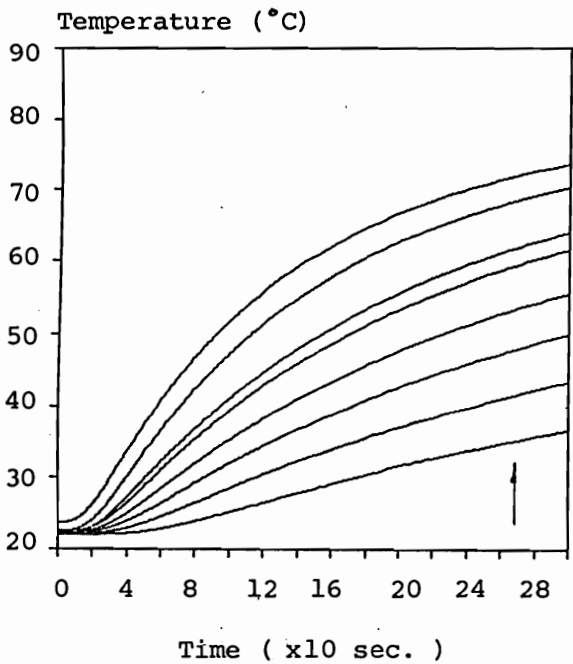

c MC = 8.9 %

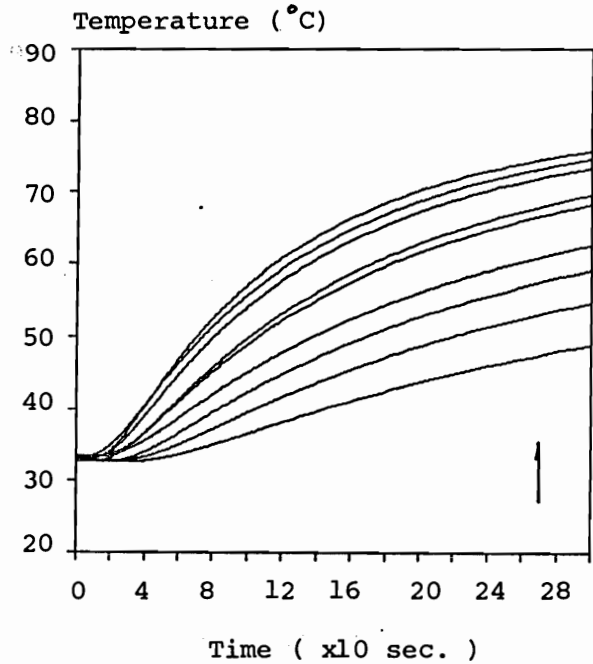

d MC = 15.8 %

↑ D = 205.8, 308.7, 411.7, 502.7, 617.5, 693.4, 797.8, 888.1, 1017.1 kg/m³

Figure 4.10. Experimental time-temperature curves for the range of density and moisture content values investigated (with plexiglas)

Table 4.6. contains the calculated thermal conductivity values, obtained by applying the regressed diffusivity (α) values in Table 4.4..

Table 4.6. Combined thermal conductivity values (W/m.°C) based on regressed diffusivity values

DENSITY (kg/m ³)	MOISTURE CONTENT (%)			
	0	4.7	8.9	15.8
205.8	0.088902	0.083206	0.112512	0.159172
308.7	0.063486	0.089030	0.105767	0.128060
411.7	0.077191	0.087975	0.108961	0.133994
502.7	0.086802	0.097919	0.119395	0.152226
617.5	0.092200	0.113209	0.125698	0.158737
693.4	0.095183	0.113734	0.134729	0.170071
797.8	0.122242	0.131213	0.154994	0.199422
888.1	0.119895	0.133004	0.162170	0.204067
1017.1	0.115698	0.130656	0.179269	0.216267

In addition to using diffusivity values derived from the regression equations of Method I, thermal conductivity values were also computed by using individual diffusivity values directly. This was possible since experimental conditions used in Method I (density and moisture content combinations) were exactly duplicated in Method II. The results are shown in Table 4.7..

Table 4.7. Conversion Results of Thermal
Conductivity (W/m.°C)

DENSITY (kg/m ³)	MOISTURE CONTENT (%)			
	0	4.7	8.9	15.8
205.8	0.091717	0.084501	0.099041	0.137267
308.7	0.061476	0.091869	0.109122	0.133043
411.7	0.079038	0.090799	0.114605	0.165140
502.7	0.086802	0.099951	0.127682	0.153440
617.5	0.089570	0.113209	0.131635	0.162392
693.4	0.092874	0.114822	0.138279	0.179556
797.8	0.119346	0.126366	0.152836	0.202242
888.1	0.128030	0.133004	0.154754	0.195985
1017.1	0.115698	0.126825	0.180235	0.204132

Figure 4.11. and Figure 4.12. graphically show the results obtained from Table 4.6. and Table 4.7..

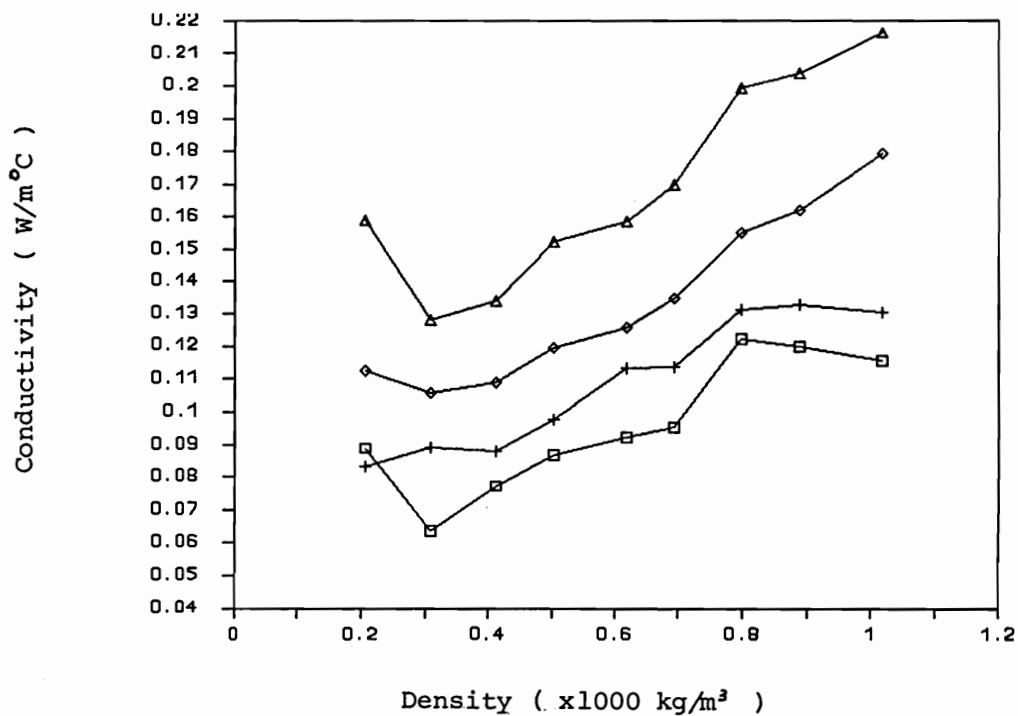

Figure 4.11. Experimentally derived conductivity values plotted against density based on regressed diffusivity

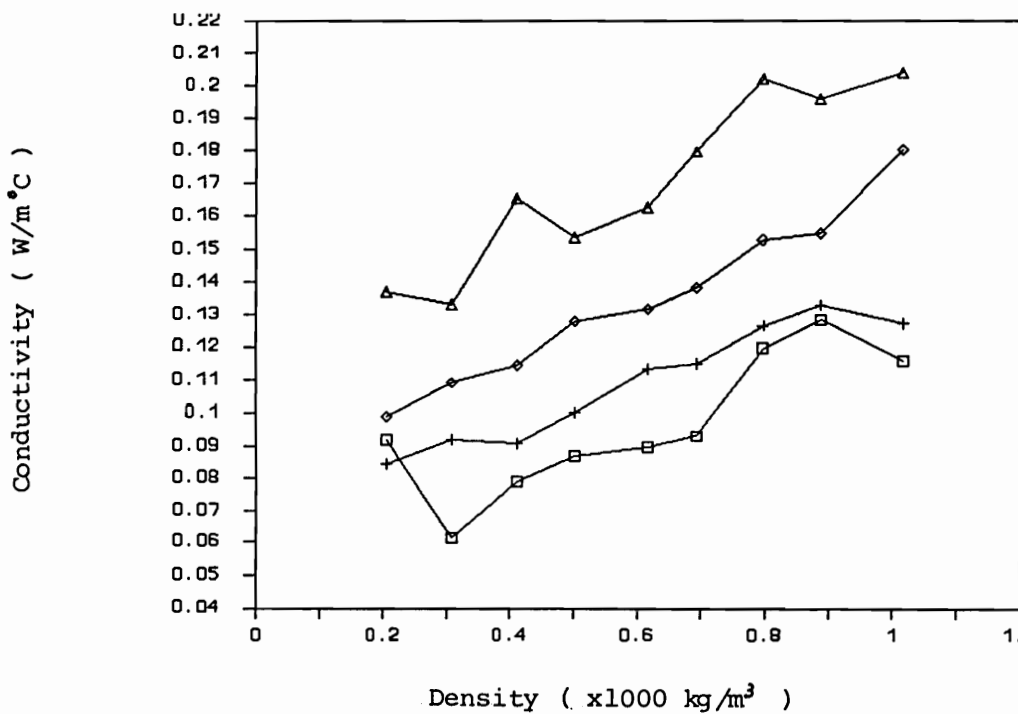

Figure 4.12. Experimentally derived conductivity values plotted against density

The results in both cases suggest possible linear relationships between the thermal conductivity and density when over 300 kg/m³. Table 4.8. and Table 4.9. summarizes the regression equations based on the data from Table 4.6. and Table 4.7.. The regressed thermal conductivity values are given in Table 4.10 and Table 4.11 respectively. The results of the regression analysis are graphically plotted in Figure 4.13. and Figure 4.14..

Table 4.8. Regression results for the effect of fiber density on thermal conductivity (based on regressed α) (W/m °C)

M.C	REGRESSION EQUATION	R ² (%)
0.0 %	$Y = 0.042759 + 0.000082 * X$	0.8807
4.7 %	$Y = 0.063740 + 0.000073 * X$	0.9094
8.9 %	$Y = 0.065667 + 0.000108 * X$	0.9697
15.8 %	$Y = 0.082264 + 0.000134 * X$	0.9712

Table 4.9. Regressions of the Thermal Conductivity of Wood Fibers on Density (W/m°C)

M.C	REGRESSION EQUATION	R ² (%)
0.0 %	$Y = 0.040006 + 0.000086 * X$	0.8603
4.7 %	$Y = 0.070151 + 0.000064 * X$	0.8997
8.9 %	$Y = 0.076798 + 0.000094 * X$	0.9630
15.8 %	$Y = 0.110489 + 0.000097 * X$	0.8671

Table 4.10. Regression Results of Thermal Conductivity (W/m °C)
based on regression diffusivity

DENSITY (kg/m ³)	MOISTURE CONTENT (%)			
	0	4.7	8.9	15.8
300	0.067359	0.08564	0.098067	0.122464
400	0.075559	0.09294	0.108867	0.135864
500	0.083759	0.10024	0.119667	0.149264
600	0.091959	0.10754	0.130467	0.162664
700	0.100159	0.11484	0.141267	0.176064
800	0.108359	0.12214	0.152067	0.189464
900	0.116559	0.12944	0.162867	0.202864
1000	0.124759	0.13674	0.173667	0.216264

Table 4.11. Regression Results of Thermal
Conductivity (W /m.°C)

DENSITY (kg/m ³)	MOISTURE CONTENT (%)			
	0	4.7	8.9	15.8
300	0.065806	0.089351	0.104998	0.139589
400	0.074406	0.095751	0.114398	0.149289
500	0.083006	0.102151	0.123798	0.158989
600	0.091606	0.108551	0.133198	0.168689
700	0.100206	0.114951	0.142598	0.178389
800	0.108806	0.121351	0.151998	0.188089
900	0.117406	0.127751	0.161398	0.197789
1000	0.126006	0.134151	0.170798	0.207489

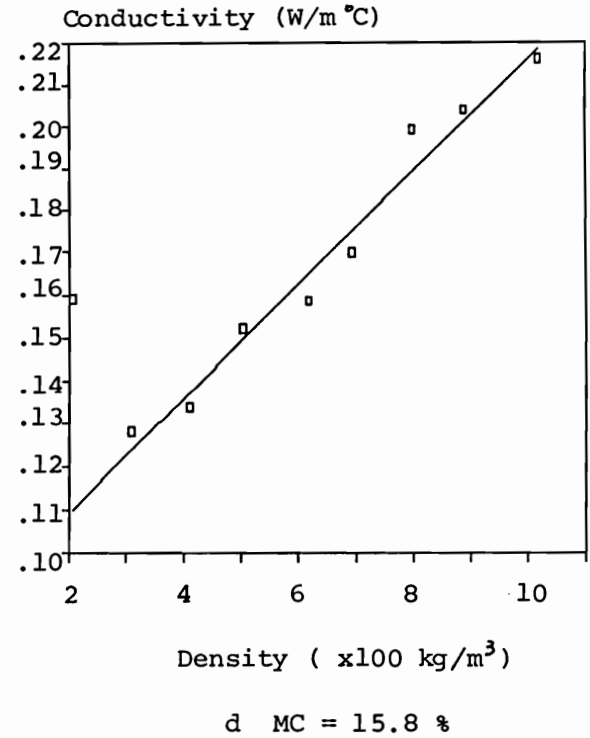
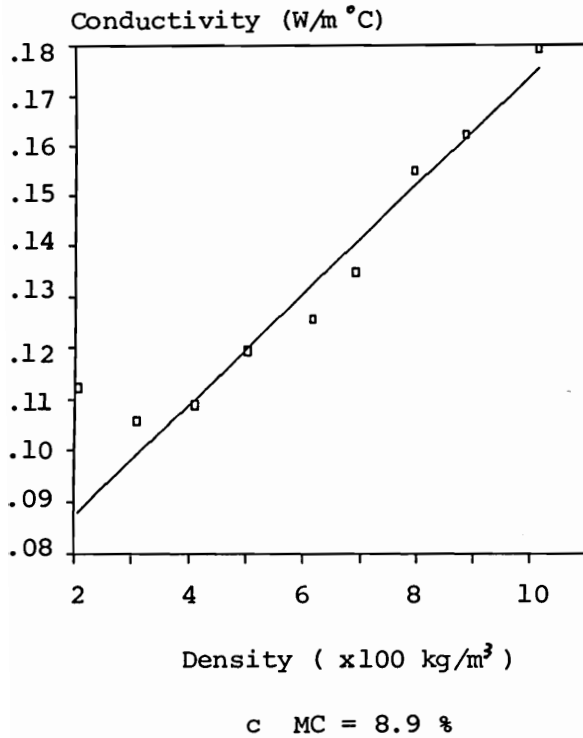
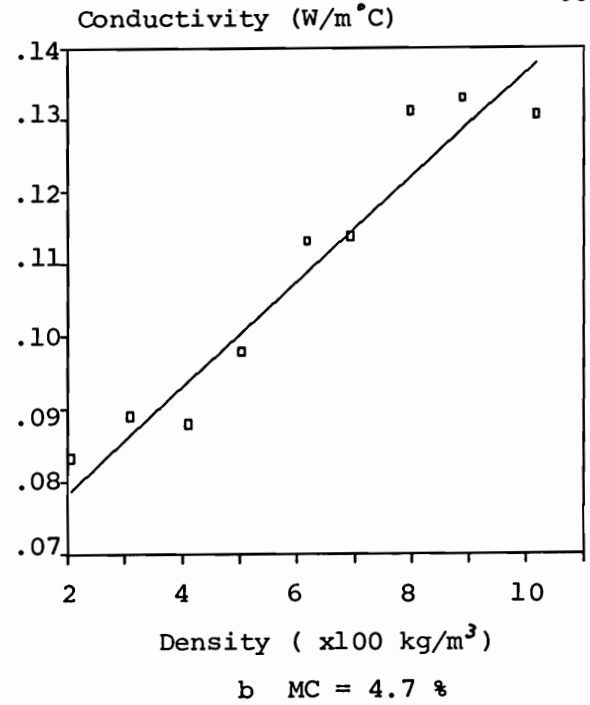
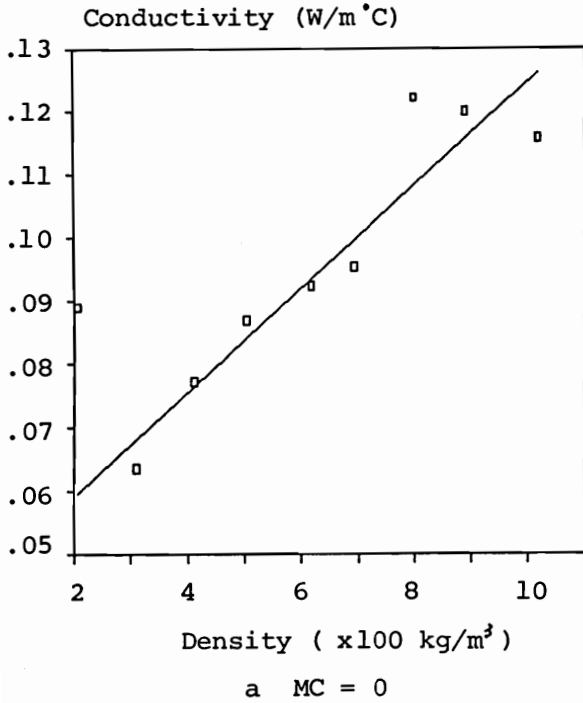

Figure 4.13. Regression of thermal conductivity (derived from regressed diffusivity) on density

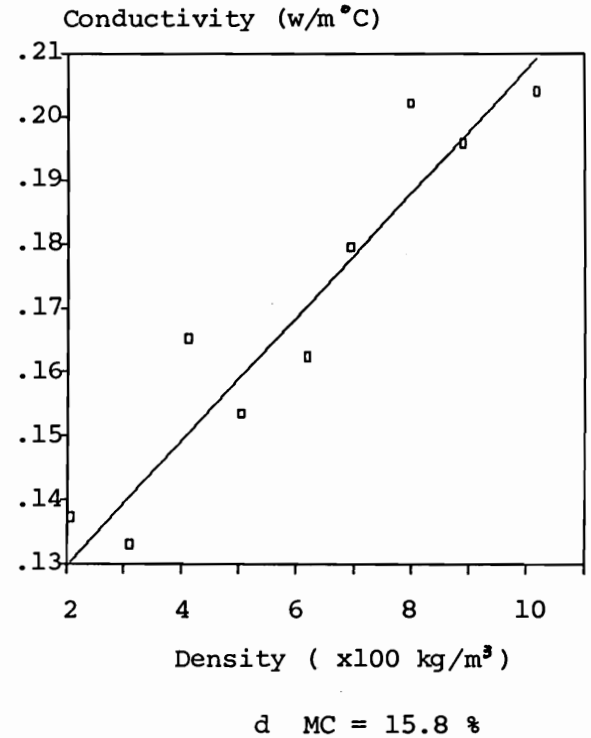
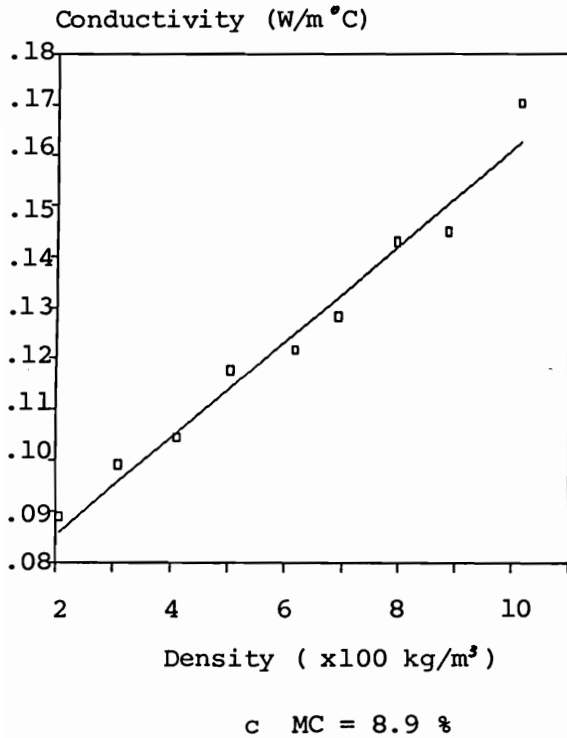
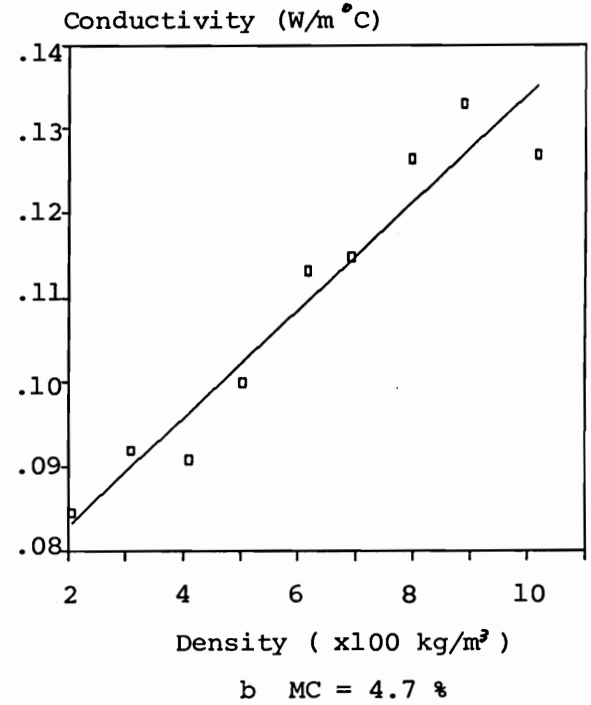
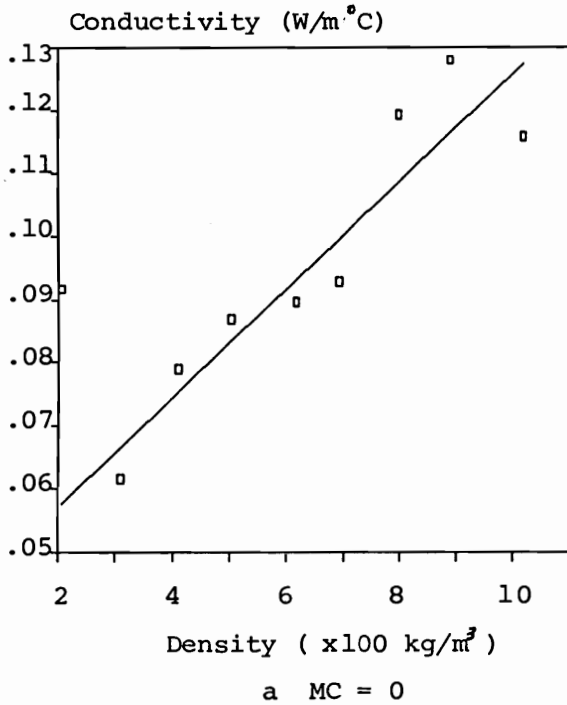

Figure 4.14. Regression of thermal conductivity on density

CHAPTER V

DISCUSSION OF RESULTS

5.1. Accuracy of Results

The inverse technique (used for Method I and Method II) applied to each group of experimental data (time vs temperature) resulted in minimized error between the theoretical and experimental time-temperature curves. Residual errors reflected the inaccuracy of the converging approach for determining the thermal parameters of the wood fiber. Sources of error in the final results could, therefore, arise from this error minimization process, the setup of the experimental equipment or the unsatisfied representation of boundary conditions in the analysis.

Experimental error

The surface temperatures of the two heated platens were controlled individually by PID (proportional-integral-differential) controllers capable of maintaining temperature within ± 0.5 °C. Furthermore, T-type thermocouple junctions, capable of resolving temperatures within about 0.1 °C, were used in all experiments. Any differences in the platen temperatures may result in unsymmetrical energy transfer toward the center of the specimens. The thermocouple junctions were placed between the two fiber disk pairs or in the center of plexiglas disks. If the two fiber disks tested were somewhat different in dimension and weight or if the thermocouples were not exactly imbedded in the center of the plexiglas disk, then the recorded temperature would be higher than

expected. This would lead to conductivity and diffusivity values which were too high.

Thickness control of the specimens when compressed was critical to the accuracy of the derived values. Inaccurate control and inference of thickness affect the thickness value to be substituted into the heat equation and the density value to which the answer is attributed.

Thickness was controlled by stops machined to a tolerance of 0.1 mm. The accuracy of thickness control was also affected by the effectiveness of corrections which were applied for the thermal expansion of the hot platens. The coefficient of thermal expansion for aluminum is given as 24.0×10^{-6} mm/mm °C

Analytical errors:

The methods employed in this research depend upon theoretical solutions of the one-dimensional unsteady-state conductive heat flow problem. Assumptions and simplifications were made in order to apply numerical analysis. Any imperfections in the match of the real experimental conditions compared to the theoretical boundary conditions bias the analytical results. The following factors relate to this kind of error.

Since the edges of the specimens were not insulated, some horizontal heat flow must have occurred within the mats as they were pressed. Considering the disk dimensions, and the fact that the mean temperature of the disks remained significantly below platen temperature for the duration of each test, it is unlikely to have been very significant; the heat energy transferred towards the interface of the

two specimens was much greater than that lost in the radial direction through the edge of the mats. Therefore, the practical heat transfer problem was simplified to one-dimensional heat flow and this was considered justified.

The heat transferred from the lower platen to the lower specimen disk before the upper platen touched the upper disk surface was ignored in the analysis. This was because at very low mat density (before compaction), the material served as a very good insulating material. Since the platens were closed to obtain target mat density within a very short time (about 15 seconds), heat transfer prior to complete closure was assumed to have little influence on the whole process of heat transfer.

It was also assumed that temperature control for the blocks was responsive enough to maintain interfacial temperatures very close to the target value (avg. 78°C). This was achieved by using PID control and blocks of moderately high thermal mass. Actual interfacial temperatures were, in any case, recorded during each test, and an average value was determined and included in the mathematical analysis.

When the specimens were pressed, heat was transferred not only by conduction, but also by convection and radiation. The influences of convection and radiation on heat and moisture transfer were unknown. However, these effects were minimized by the use of a relatively low pressing temperature (78°C) and short testing times. This combination of treatments minimized the extent of phase change, convective heat and mass transfer and associated re-distribution of bound water.

5.2. Similarities Between the Experimental Method and Commercial Heat Pressing Operations

The experimental arrangement employed in this investigation were rather similar, on a small scale, to commercial hot pressing operations. However, the low platen temperature applied in this investigation greatly affected the relative magnitude of the contributory processes.

The hot-pressing operation has been studied by a number of researchers (Stickler, 1959; Suchland, 1967; Smith, 1982 Humphrey and Bolton, 1989; Kamke and Casey, 1988). The extremely complicated physical process involve simultaneous heat and mass transfer, with an internal chemical reaction and phase change (Kamke and Casey, 1988). The mechanisms of heat and moisture transfer during the manufacture of particleboards includes: a) conduction by transferring heat from the platens to the mattress and between constituents of the mattress, b) convection resulting from phase change of adsorbed moisture and resultant vapor or gas pressure gradients, c) radiation - mostly happening before the upper platen closes and within the mattress during the very early stages of the pressing cycle (at low densities), d) capillary translation of liquid occurring by flow of condensed liquids through the capillary structure of the board, e) diffusion of bound water in wood cell walls (Humphrey and Bolton, 1989). The variables of platen temperature, initial mat moisture content, press closing rate, pressing time, and compaction pressure affect the process of heat and moisture transfer in wood based composites.

Convection occurs because heat transferred into the mattress causes vaporization of the furnish moisture, thus increasing the water

vapor pressure within the voids of the material. This creates a vapor pressure gradient across the board thickness, and this in turn causes flow, and transfer of the heat content of the vapor. Internal vapor pressures are affected by initial mat moisture content and platen temperature (along with its permeability and hygroscopicity).

In the present research, during the two minute pressing cycle, conductive heat transfer from the platens to the mat and within the mat was recognized as the only significant mechanism of heat transfer. With the platen temperature of 78°C, it was unlikely that vapor pressures significantly above the partial vapor pressure in the ambient atmosphere built up inside the mat. The observations made by Humphrey and Bolton (1989) may support this statement. When pressing the particleboard mattresses at 115°C, during a 200 second press closing time, no increase in vapor pressure was detected (Figure 5.1.).

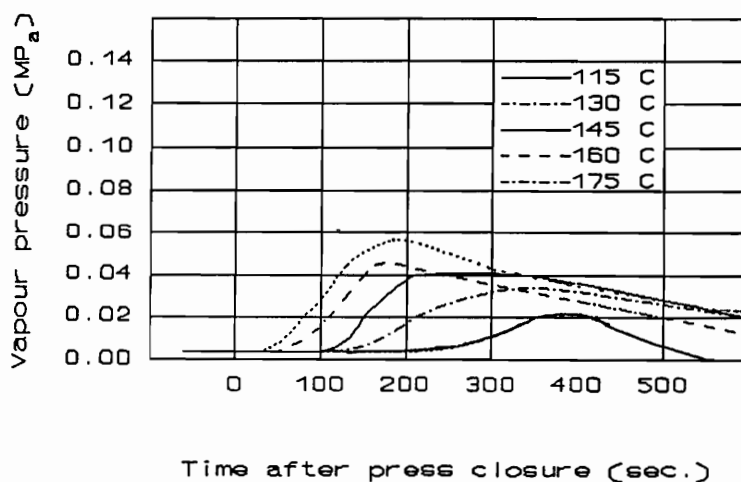

Figure 5.1. Vapor pressure variation with time after closure for different platen temperature (from Bolton & Humphrey, 1989)

It was observed in the present experiments that below 120 seconds the theoretical curve generated from the converged thermal parameters fit the experimental curve well. Over 120 seconds, the theoretical value would eventually be higher than the experimental value, especially at lower specimen density. This phenomenon suggests that the movement of moisture within the mat may become significant at longer pressing times. Actually, any change in temperature would affect the equilibrium gas pressure and moisture content of wood, and thus the partial pressure in the surrounding air. Some vapor flow will occur whenever there is any partial pressure gradient. At low mat densities, fiber mattress permeability would be high, so gas and water vapor could easily be transferred within the mat. However, energy transfer by conduction which is necessary to affect phase change is small at low densities. As time increases, the loss of surface moisture must result in some decrease of vertical heat conductivity. At the same time, the phase change consumes some energy that would otherwise have affected temperature rise.

Press closing times influence the cross sectional density profile of wood-based composites. The interactive effect of temperature and moisture content on mat compressibility is responsible for the formation of such density profiles. With very short closing times, the density profile is U-shaped (Smith, 1982). In this investigation, some differential densitification could have occurred, though the relatively low temperature employed and associated lack of moisture migration is likely to have reduced the effect very considerably.

5.3. Discussion of Results

5.3.1 Thermal Diffusivity

Thermal diffusivity appeared to be related logarithmical to density for every group of tests at the same moisture content. After logarithmic transformation, a well defined linear relationship was apparent (Figure 5.2.). When holding density constant, thermal diffusivity was found to be proportional to moisture content.

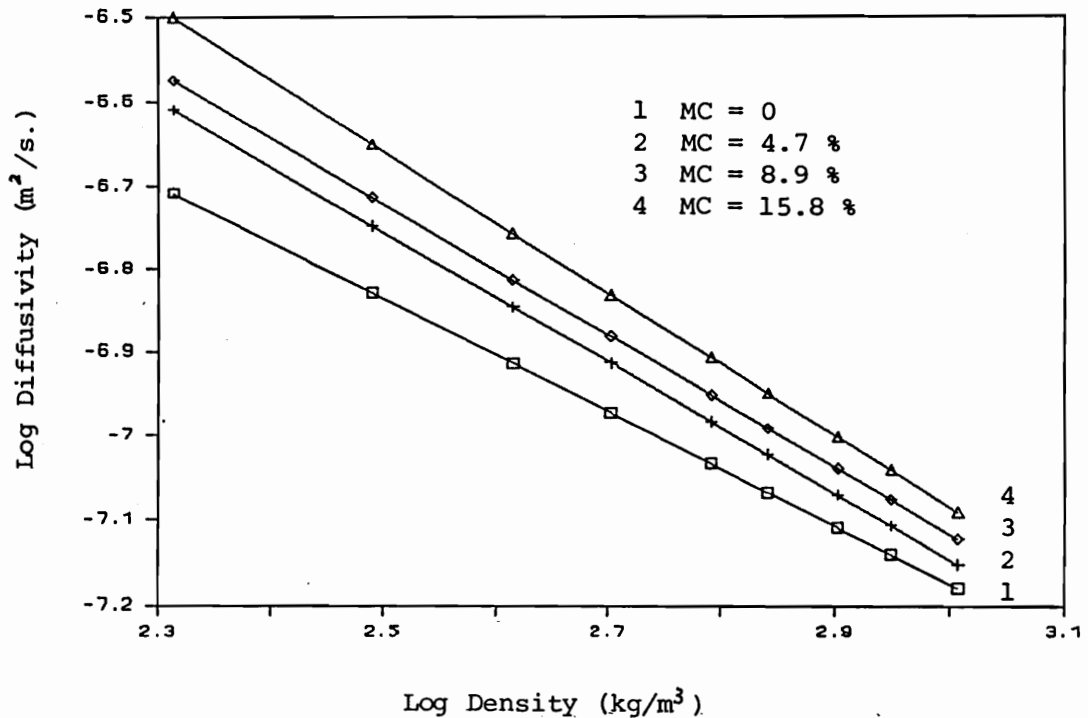

Figure 5.2. Linear relationship between density and diffusivity after logarithmic transformation

A general relationship between the thermal diffusivity and density was expected. At low fiber mat density values (200 kg/m^3 - 500 kg/m^3), density had a significant influence on thermal diffusivity. Figure 5.3.

shows that as density increased, the influence of density decreased considerably. This could be explained by the fact that at low density, fiber disks are very permeable, so that convection could influence heat transfer. Radiation may also affect the rate of heat transfer at low density. Alternatively, it is likely that the pathways for heat transfer through fiber networks change as density changes. Such transitions in conductive mechanism most likely cause the deviation from more conventional density-diffusivity relationships.

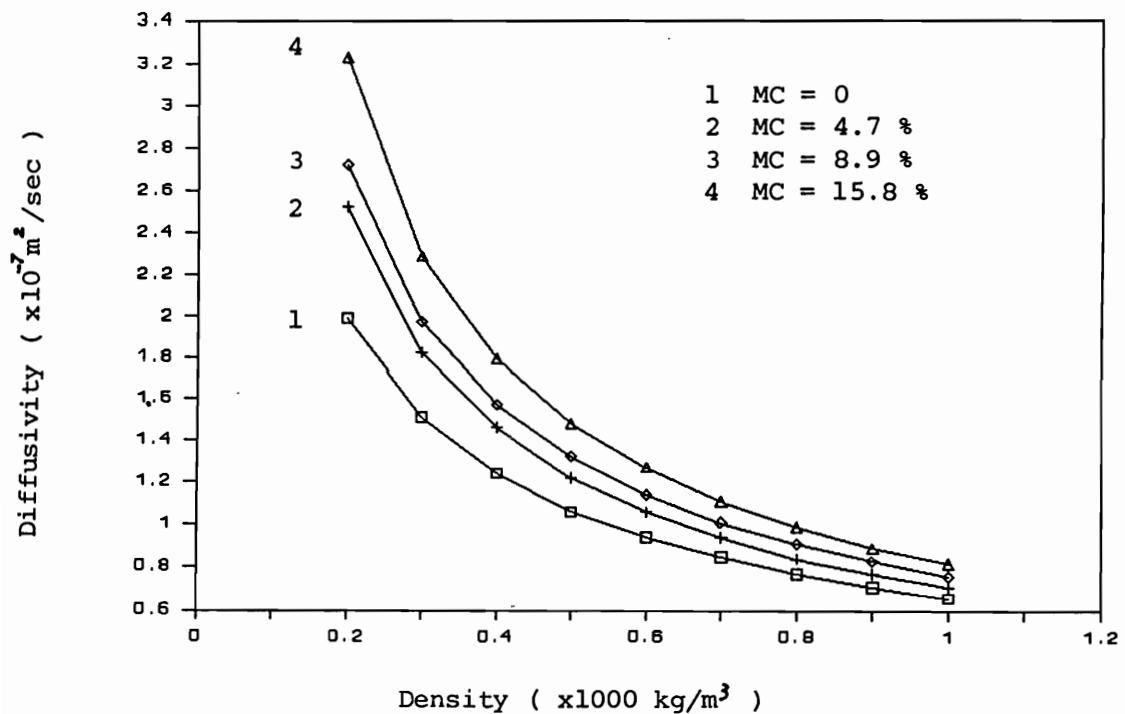
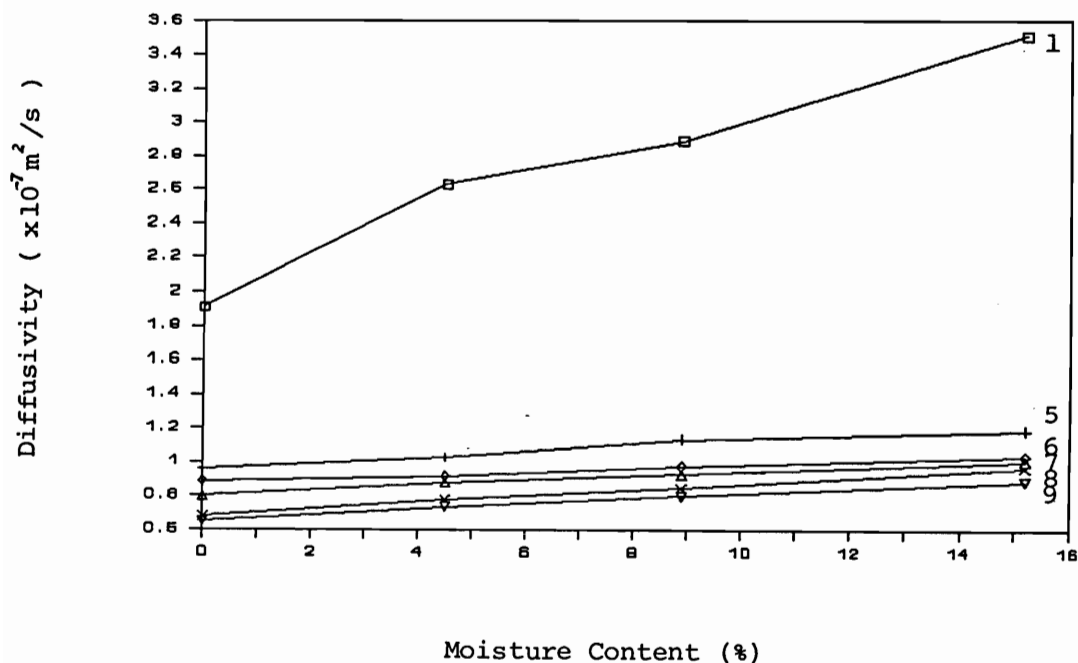
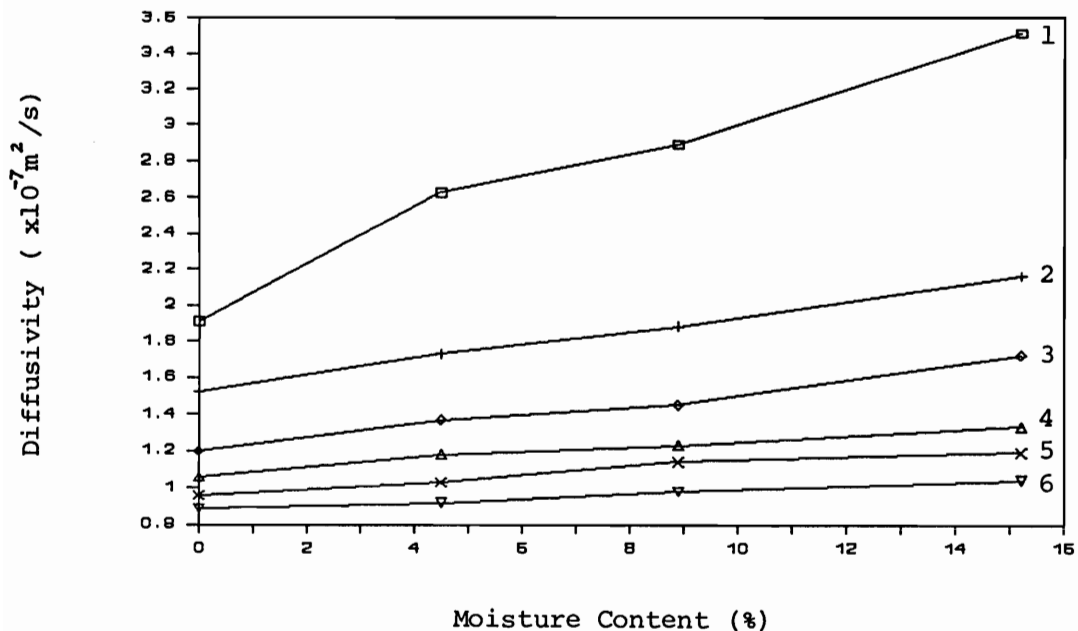

Figure 5.3. Derived density-diffusivity relationship

The results confirm that moisture content affects thermal diffusivity of wood fibers. At similar mat densities, thermal diffusivity appears to increase almost linearly with moisture content, although the effect is not as pronounced as that for mat density (Figure 5.4.).



- | | | |
|-------------------------------|-------------------------------|--------------------------------|
| 1 D = 205.8 kg/m ³ | 4 D = 502.7 kg/m ³ | 7 D = 797.8 kg/m ³ |
| 2 D = 308.7 kg/m ³ | 5 D = 617.5 kg/m ³ | 8 D = 888.1 kg/m ³ |
| 3 D = 411.7 kg/m ³ | 6 D = 693.4 kg/m ³ | 9 D = 1017.1 kg/m ³ |

Figure 5.4. Effects of moisture on thermal diffusivity

A comparison of the calculated values of thermal diffusivity with the experimental results of other observers is not possible because no investigation could be found in the literature for wood fiber networks. Generally, thermal diffusivity is derived from known values for thermal conductivity, specific heat and density (knowing that $\alpha = K/\rho c$).

5.3.2 Thermal Conductivity

The results confirm that thermal conductivity is directly related to the specific gravity of the wood fibers. This had been shown before by several investigators. Conductive heat transfer through the wood fiber networks apparently depends mainly on vibrating molecules exciting the ones adjacent to them. The greater the number of ways these molecules can be excited or vibrated, the greater would be the transmission of energy from one molecule to the next. At high density, the distance between fibers and therefore their constituent molecules are much smaller. Moisture content also affects the rate of heat transfer. High moisture content leads to a high thermal conductivity value. Figure 5.5. shows the thermal conductivity and density relationship as a function of moisture content.

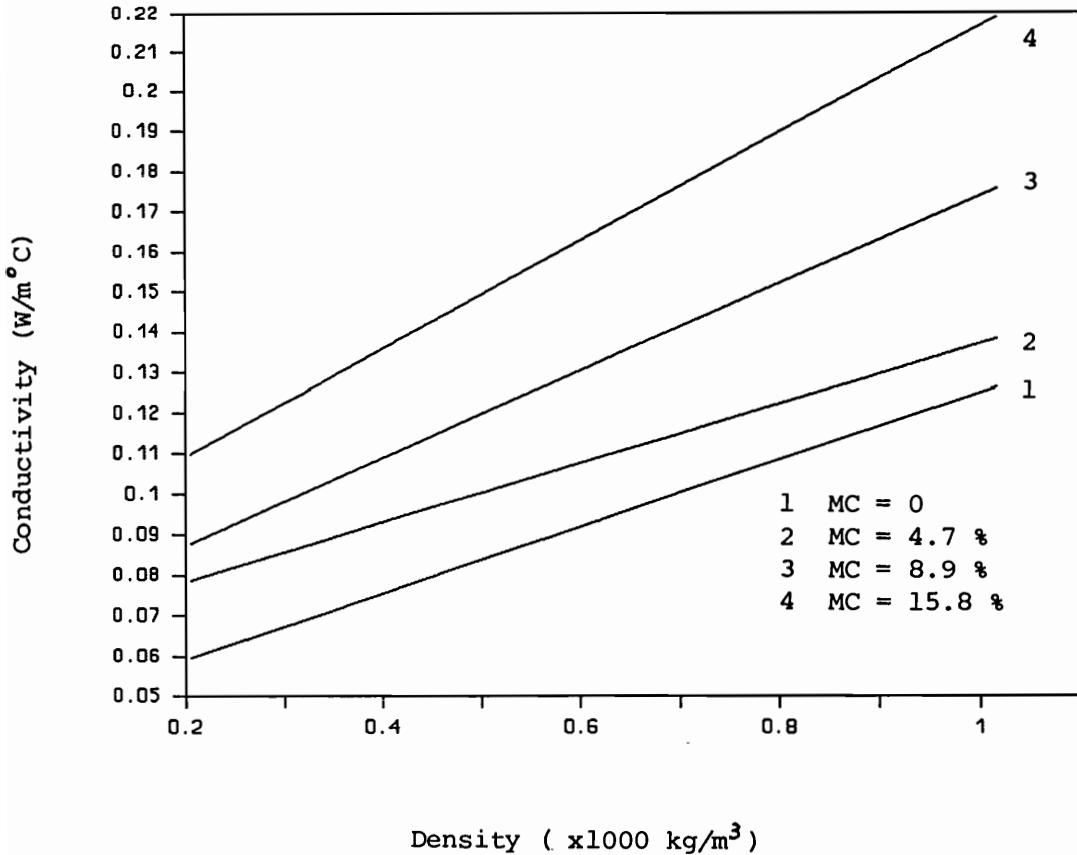

Figure 5.5. Derived linear relationship between thermal conductivity and density under different moisture levels

Again, comparison of the calculated values of thermal conductivity with the experimental results of other observers is not possible because there are few sources of data which give the thermal conductivity of wood fiber networks. Most of the work done by other workers has been on wood and particleboard using the steady-state, hot plate method. Figure 5.6. gives a comparison of the calculated thermal conductivity values obtained from this research and those obtained from Lewis' experiment (Lewis, 1967) on wood based fiber board, and also with the data

published by Kollmman on fiber board (Kollmman, 1956). Comparison of these results with those of Lewis at zero moisture content and similar temperature indicates some agreement. The relatively small differences may be due to experimental errors and differences in material types. Kollmman's thermal conductivity value was lower than that of this experiment.

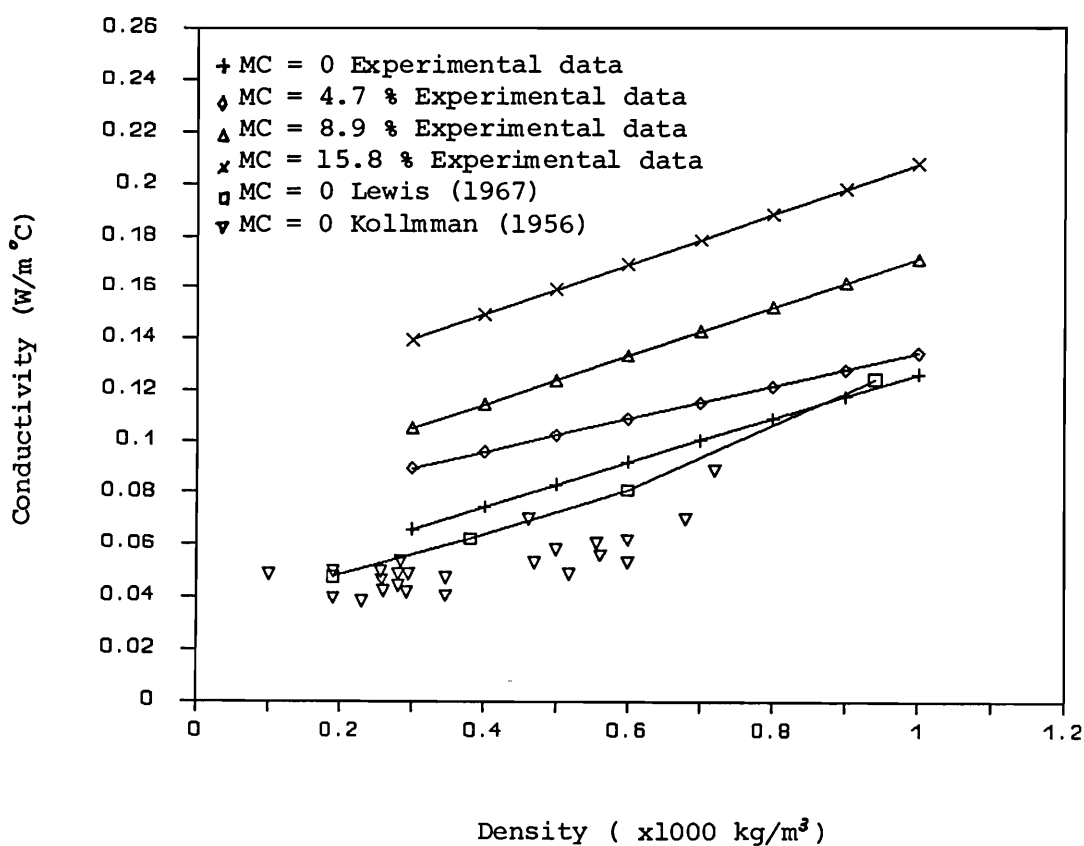

Figure 5.6. Comparison of derived thermal conductivity of wood fiber with that of other published data

5.3.3. Specific Heat

Measured specific heat values were highly variable. No clear relationship could be detected between the specific heat and density at constant moisture content. However, moisture content of the mat did appear to affect measured specific heat values (Figure 5.7.). The average specific heat values at the moisture contents of 0, 4.7, 8.9 and 15.8% were in the range of 1664, 1741, 1980 and 2206 J/kg°C respectively.

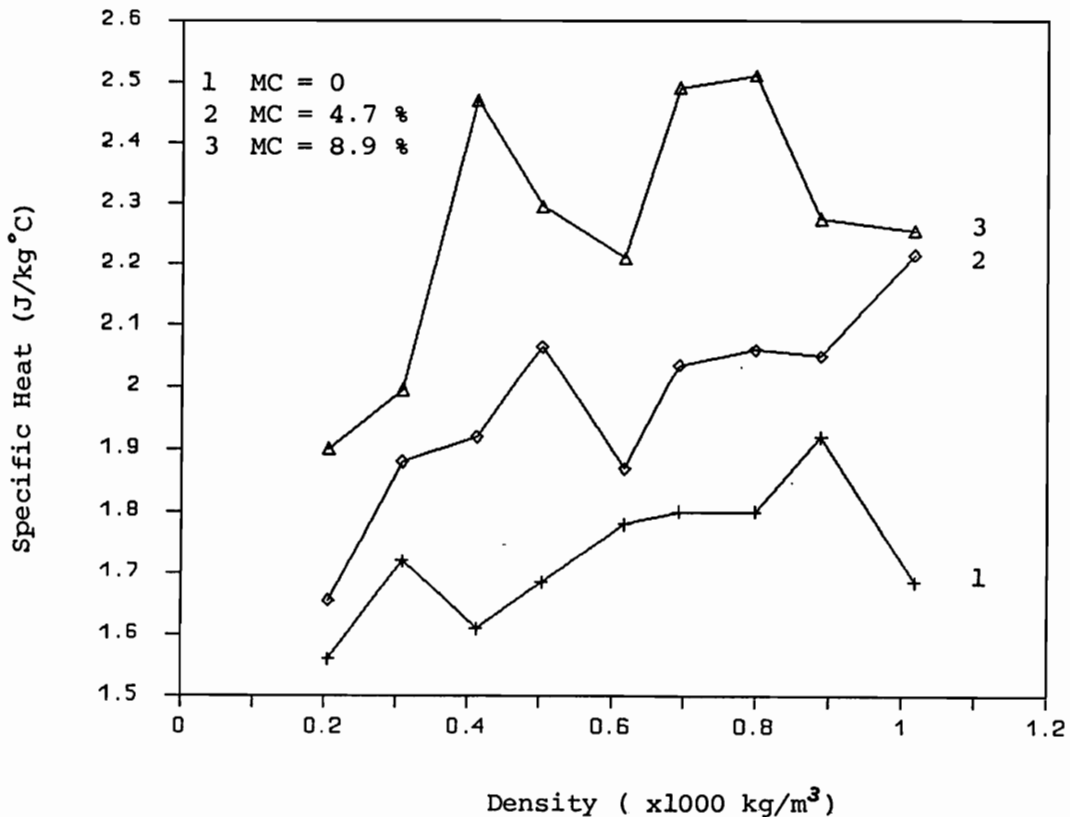

Figure 5.7. Effects of moisture on derived Specific heat values

The unreliability of these data reflects the insensitivity of the methods accuracy to specific heat. In other words, large changes in specific heat are necessary to affect significant changes in calculated thermal conductivity values. For this reason, the specific heat data presented here will not be used in modelling the hot pressing of composites. It is, however, considered that conductivity and diffusivity data is of sufficient accuracy to warrant its use.

CHAPTER VI

CONCLUSIONS AND RECOMMENDATIONS

6.1 Conclusions from the Current Research

1) A dynamic method has been developed and evaluated which determines the thermal diffusivity and thermal conductivity of wood-based composite materials. Advantages of this unsteady-state method are that it involves relatively simple instrumentation, a short time (about two minutes) is required to produce the time-temperature records for the measurement at a given density and moisture content, and no significant change in the moisture content of the specimen occurs during the experiment.

2) The results of this study indicate the basic testing system used can, with some improvements on accuracy, give quite reliable results for the thermal parameters of wood based composites and similar insulating materials throughout a wide density range. Furthermore, the influence of moisture content on the diffusivity and thermal conductivity may be investigated with this method.

3) The thermal diffusivity of wood fiber networks was tested and is related to compaction density and moisture content. A logarithmic relationship was found between thermal diffusivity and density of the wood fiber networks tested. Moisture content had a positive influence on thermal diffusivity. Under the same moisture conditions, this influence did not vary significantly with different density values.

4) From this research, it is shown that, over the range of densities investigated, the thermal conductivity of wood fiber networks

was linearly related to their density. Increases in network moisture content led to an increase in thermal conductivity. The influence of moisture content on the thermal conductivity of the networks appeared to be independent of density.

6.2 Recommendations for future research

- 1) The accuracy of the test results could be improved by:
 - a. insulating the edges of the test specimens;
 - b. increasing the rate and accuracy of position control to achieve target density values quickly;
 - c. improving moisture content control for the specimens prior to the testing operation applied.

2) Further studies on the experimental system are needed in order to investigate the following:

- a. how the platen temperature and initial specimen temperature affect the experimental accuracy;
- b. how the pressing time influences the accuracy of the mathematical convergence routine;
- c. Over what range of moisture content the method proves reliable;
- d. what types of material perform well as a heat sink.

3) The technique may be applied to a range of other insulating materials in order to evaluate the applicability of the experimental system and to diverse types.

BIBLIOGRAPHY

- ASTM. 1980. Standard methods of fire tests of building construction and materials. C-177, Philadelphia, PA.
- ASTM. 1980. Standard methods for mean specific heat of thermal insulation. C351-61, Philadelphia, PA.
- Beall, F. 1968. Specific heat of wood - further research required to obtain meaningful data. USDA Forest Serv. Res. Note FPL-184. Forest Prod. Lab. Madison, WI.
- Bolton, A. J., P. E. Humphrey and P. K. Kavvouras. 1989. The hot pressing of dry-formed Wood-based composites. Part III, Predicted vapour pressure and temperature variation with time, compared with experimental data for laboratory board. *Holzforschung*. 43(4):265-274.
- Carslaw, H. S. and J. C. Jaeger. 1959. Conduction of heat in solids. Clarendon Press, Oxford, England, 2nd ed.
- Clarke, L. N. and R. S. Kingston. 1950. Equipment for the simultaneous determination of thermal conductivity and diffusivity of insulating materials using a variable-state method. *Australian J. Applied Science*. 2(2):35-242.
- Clarke, L. N. 1954. A method of measuring the thermal conductivity of poor conductors. *Australian J. Applied Science*. 5(2):178-182.
- Dunlap, F. 1912. The specific heat of wood. U. S. Forest Service Bulletin No.110.
- Gammon, B. W. 1987. Reliability analysis of wood-frame wall assemblies exposed to fire. Ph. D. Thesis, Univ. of California. Berkeley, CA.
- Gilbo, C. F. 1951. Experiments with a guarded hot plate thermal conductivity set. In Proc. Symp. on Thermal insulating materials. ASTM Special Tech. Pub. 119:45-55.
- Grober, H. 1910. Wärmeleitfähigkeit von isolier-und baustoffen. *Z. Ver deutsch. Ing.* 54:1319-1324.
- Humphrey, P. E. and A. J. Bolton. 1989. The hot pressing of dry formed wood-based composites. Part II. A simulation model for heat and moisture transfer, and typical results. *Holzforschung*. 43(3):190-206.
- Kamke, F. A. and L. J. Casey. 1988. Fundamentals of flakeboard manufacture: internal-mat conditions. *Forest Products Journal*. 38(6):38-44.

- Kanter. 1957. The thermal properties of wood. U. S. Dep. Comm. office Tech. Serv. OTS 60-51033.
- Kollmann, F. 1951. Technologie des Holzes und der Holzwerkstoffe, 2nd Ed. Vol. 1, Springer-Verlag, Berlin-Göttingen-Heidelberg.
- Kollmann, F. and L. Malmquist. 1956. The coefficient of thermal conductivity of wood and wood based material. Holz als Roh- und Werkstoff. 14(6):201-204.
- Kollmann, F. F. P. and Côté, Jr., W. A. 1968. Principles of wood science and technology. Springer-Verlag, Inc. New York.
- Kreith, F. 1958. Principles of heat transfer (1st Ed). Haddon Craftsmen, Inc., Scranton, PA.
- Kuhlmann, G. 1962. Untersuchung der thermischen eigenschaften von Holz und spanplatten in abhangigkeit und temperatur im hydroskopischen bereich. Holz Als Roh und-Werksstoff. 20(7):259-270.
- Lewis, W. C. 1967. Thermal conductivity of wood-base fiber and particle panel materials. USDA Forest Serv. Research Paper FPL-77. Forest Prod. Lab. Madison, WI.
- MacLean, J. D. 1941. Thermal conductivity of wood. Heating, Piping and Air Conditioning. 13:380-391.
- MacLean, J. D. 1930. Studies of heat conduction in wood. Results of steaming green round Southern pine timbers. Proc. A. W. P. A. p197.
- Maku, T. 1954. Studies on the heat conductive in wood. Bulletin of the Wood Research Institute. No.13, Kyoto Univ..
- McMillin, C. W. 1969. Specific heat of oven-dry Loblolly pine wood. Wood Science. 2(2):107-111.
- Nanassy, A. J. and T. Szabo. 1978. Thermal properties of waferboards as determined by a transient method. Wood Science. 11(1):17-22.
- Nanassy, A. J. 1978. Flame retardant effects on thermal properties of wood-char studied by the transient method. Wood Science. 11(2):111-117
- Narayanamurti, D. and V. Ranganathan. 1941. The thermal conductivity of Indian timber. The Proceedings of the Indian Academy of Sciences. 13(4):Sec. A.
- Parsons, J. J. 1955. The determination of thermal conductivity and specific heat by non-steady flow. Paper No. 2.31 from 9th International Congress on Refrigeration, Paris.

- Poensgen, R. 1912. Ein technische verfahren zur ermittlung der wärmeleitfähigkeit plattenformigen stoffe. Z. Verdeutsch. Ing. 56:1653-1658.
- Pratt, A. W. and J. M. E. Ball. 1956. Thermal conductivity of building materials: method of determination and results. J. The institute of heating and ventilating engineers. 24:201-225.
- Rowley, F. B. 1933. The heat conductivity of wood at climatic temperature differences. Heating, Piping and Air Conditioning. 5:313-323.
- Smith, D. C. 1982. Waferboard press closing strategies. Forest Products Journal. 32(3):40-45.
- Steininnhagen, H. P. 1977. Thermal conductive properties of wood. green or dry from 40°C to 100°C -- a literature review. USDA Forest Serv. Gen. Tech. Report FPL-9. Forest Prod. Lab. Madison, WI.
- Strickler, M. D. 1959. Effect of presscycles and moisture content on properties of douglas-fir flakeboard. Forest Products Journal. 9(7):203-215.
- Suchsland, O. 1959. Behavior of a particleboard mat during the press cycle. Forest Products Journal. 17(2):51-57.
- Thunell, B. and H. Lundquist. 1945. Trätorkning I, Svenska Träforskningsinstitutet, Trätekniska Avdel., Medd. 4, Van Dusen, M. S. 1920. The thermal conductivity of heat insulators. J. Am. Soc. Heat. Vent. Eng. 26:625-656.
- Vernotte, P. 1937. Determination simultance de la chaleur specifique et de la conductibilite thermique des isolants. Methods du signal. C. R. Acad. Sci. Paris. 204:563 (As cited by Clarke, 1950).
- Wangaard, F. F. 1969. Heat transmissivity of southern pine wood, plywood, fiberboard, and particleboard. Wood Science. 2(1):54-60.
- Ward, R, J. 1960. A dynamic method for determining specific heat and thermal conductivity of wood based materials as a function of temperature. unaplished master theses, State University college of Forestry at Syracuse University.
- Ward, R. J. and C. Skaar. 1963. Specific heat and conductivity of particleboard as function of temperature. Forest Products Journal. 13(1):31-38.

APPENDICES

APPENDIX A

Fortran Program for Method I

```

c      program fpaug31.for
c*****
c***   To determine the thermal diffusivity of wood by comparing ***
c***   the analytic Fourier series solution for temperature with ***
c***   the experimental data. both taken at  $x=1/2$ , as a function **
c***   of time. ***
c***   Variables ***
c***   a(i)=thermal diffusivities ***
c***   aerr(i)=error for a(i) ***
c***   tempe(i)=temperature of experimental data ***
c***   tempm(i)=temperature of theoretical solutions ***
c***   t(i)=time in sec. ***
c***   thick=specimen thickness ***
c***   t0=initial temperature(i.e. room temperature) ***
c***   t1=platen temperature(for example 80 degree C) ***
c***   ntime=# of points in math. model ***
c***   ndiff=# of sub-division for diffusivity ***
c***   switch=0 if sort complete;1 if not complete. ***
c***   storea=temporary storage location for diffusivity ***
c***   storerr=temporary storage location for error ***
c***   ne=# of points in data file(total time*frequency) ***
c***   icount=# of points which are selected from data file ***
c***   iskip=# of points which you want to skip ***
c*****

```

```

      real t(1000),tempe(1000),tempm(1500),a(1001),aerr(1001)
$,ts(1500),tempes(1500)
      integer switch
      data switch/1/
      write(*,*)' t1(platen temperature. ie. 78 or 80 or 82)=?'
      read(*,*)t1
      write(*,*)'thickness of specimen. ie.total length,L (mm)=?'
      read(*,*)thick
      write(*,*)'small guess for diffusivity (ie. a(1))=?'
      read(*,*)a(1)
      write(*,*)'How many sub-division do you want for diffusivity=?'
      read(*,*)ndiff
      write(*,*)'large guess for diffusivity (ie. a(ndiff+1))=?'
      read(*,*)a(ndiff+1)
      write(*,*)'ntime(total testing time(sec)*5 ie.(300sec.=1500)=?'
      read(*,*)ntime
      write(*,*)'ne(total testing time(seconds) *frequency)=?'
      read(*,*)ne
      write(*,*)'iskip(time*frequency,ie. 6sec.s=30)=?'
      read(*,*)iskip

```

```

    open(3,file='data',status='old')
    pi=4.*atan(1.)
    do 170 j=1,ne
    read(3,*)ts(j),tempes(j)
170  continue
    endfile(3)
    close(3)
    icount=0
    write(*,*)'Time      Temperature'
    do 100 j=1,ne,iskip
    icount=icount+1
    t(icount)=ts(j)
    tempe(icount)=tempes(j)
    write(*,*)t(icount),tempe(icount)
100  continue
    write(*,*)'total points selected= ',icount
    t0=tempe(1)
    ain=a(1)
    alast=a(ndiff+1)
    dela=(a(ndiff+1)-a(1))/real(ndiff)
    write(*,*)'diffusivity increment = ',dela
    do 140 i=2,ndiff
140  a(i)=a(1)+(a(ndiff+1)-a(1))/real(ndiff)*real(i-1)
c compute the difference between experimental data and mathmodel
    write(*,*)'diffusivity      total error '
    open(5,file='errr',status='old')
    write(5,*)'diffusivity      total error'
    do 110 ia=1,ndiff+1
    aerr(ia)=0.0
    do 50 j=1,icount
    call tempcalc(t0,t1,a(ia),thick,t(j),tempa)
    aerr(ia)=aerr(ia)+(tempa-tempe(j))**2
50  continue
    write(*,*)a(ia),aerr(ia)
    write(5,*)a(ia),aerr(ia)
110  continue
    endfile(5)
    close(5)
c sort aerr in ascending order
120  if(switch.eq.1)then
    switch=0
    do 130 k=2,ndiff+1
    if(aerr(k).lt.aerr(k-1))then
    storerr=aerr(k)
    aerr(k)=aerr(k-1)
    aerr(k-1)=storerr
    storea=a(k)
    a(k)=a(k-1)
    a(k-1)=storea
    switch=1
    end if
130  continue

```



```

        goto 120
    end if
c write tempm files
    open(unit=4,file='tempmm',STATUS='old')
    write(4,*)'t0( c) t1( c) thickness(mm) '
    write(4,*)t0,t1,thick
    write(4,*)'a(1)=smallest diff., aerr(1)=smallest error '
    write(4,*)a(1),aerr(1)
    write(4,*)'ain(small guess), alast(large guess),dela(increment) '
    write(4,*)ain,alast,dela
    do 70 i=1,600
        t(i)=0.5*real(i)
        call tempcalc(t0,t1,a(1),thick,t(i),tempal)
        tempml(i)=tempal
70    write(4,80)t(i),tempml(i)
80    format(f6.2,f15.6)
    endfile(4)
    close(unit=4)
    stop
    end
c*****
    subroutine tempcalc(t0,t1,ab,thick,time,temp)
c*****
        pi=4.*atan(1.)
        sum=0.0
        sgn=1.0
        do 30 n=1,50
            power=-1.0*(((2.0*real(n)-1.0)*pi/thick)**2)*ab*time
            term=exp(power)/(2.0*real(n)-1.0)
            sum=sum+sgn*term
            if(term.lt.1e-06)goto 40
            sgn=sgn*(-1.0)
30        continue
40        continue
        temp=t1-(4.0*(t1-t0)*sum)/pi
        return
    end

```

APPENDIX B

Fortran Program for Method II

```
$debug
```

```
c program thermo.for(Sep 6,1988)
```

```
c*****  
**
```

```
c This program computes thermal conductivity.  
c The data is obtained from an experiment involving a rod of two  
c materials as shown below:
```

```
c  
c I'////////I'////////I'////////I'////////I  
c A I #1 I #2 I #2 I #1 I B  
c I,,,,,,,,,I,,,,,,,,,I,,,,,,,,,I,,,,,,,,,I  
c  
c < x11 >< x12 >< x12 >< x11 >
```

```
c Material #1: wood , Material #2: plexiglas.  
c Here, the insulated rod, initially at temperature T0, is subject  
c to a source of constant temperature, T1, at A and B, and the  
c temperature measured in time at the center of rod joining the  
c sections of material #2. Given this temperature data as well as  
c a few other items this program computes estimates of the specific  
c heat c and thermal conductivity k of wood. We know diffusivity  
c and density of wood. We also know thermal conductivity, specific  
c heat and density of plexiglas.
```

```
c On input (argument list):
```

```
c a =diffusivity of wood [m2/sec]  
c b =diffusivity of plexiglas [m2/sec]  
c wk = Thermal conductivity of the wood [w/m deg C].  
c pkpa = Thermal conductivity of the plexiglas [w/m deg C].  
c row =density of wood [kg/m3]  
c sip =density of plexiglas [kg/m3]  
c cw(i) =specific heat of wood [J/kg deg C]  
c gamp =specific heat of plexiglas [J/kg deg C]  
c xkk = Ratio k(wood)/k(plexiglas) =wk/pkpa  
c t(i) = Time [sec].  
c result = Array containing the modified roots computed  
c for the same material parameters by routine  
c ROOTS(elams).  
c ta =sqrt(a)  
c tb =sqrt(b)  
c cc =xkk*tb/ta=sqrt(b/a)*wk/pkpa  
c aa =x11/sqrt(a)  
c bb =x12/sqrt(b)  
c cw(i) =specific heat(maximum 500 subdivision)  
c cwerr(i) =Total error in comparison for cw(i)  
c delcw =Specific heat increment  
c switch=0 if sort complete;1 if not complete.
```

```

c      x11      = Length of the wood layer [m].
c      x12      = Length of the plexiglas layer [m].
c      t0       = Initial (equilibrium) temperature [deg C].
c      t1       = Platen temperature [deg C].
c      nterms   = Number of eigenvalues which we want to find.
c      storec   =temporary storage location for specific heat
c      sterr    =temporary storage location for error
c      ne       =# of points in data file(total time*frequency)
c      ntime    =# of points in math. model
c      icount   =# of points which are selected from data file
c      iskip    =# of points which you want to skip
c      On output files:
c      tempm    = Computed temperature [deg C].
c      eigen    =eigenvalues
c      err      =total error(USING SQUARED ERROR)
c              for specific heat cw(i)
c
c*****
dimension t(300),tempe(300),tempm(1000),result(50),cw(501),
$swerr(501),ts(1000),tempes(1000),cc(501)
integer switch
data switch/1/
data pkpa/0.2/,gamp/1500.0/,sip/1190.0/,x12/0.0029765/
write(*,*)' t1(platen temperature. ie. 78 or 80 or 82)=?'
read(*,*)t1
write(*,*)'thickness of specimen. ie.length,x11 (m)=?'
read(*,*)x11
write(*,*)'small guess for specific heat (ie. cw(1))=?'
read(*,*)cw(1)
write(*,*)'How many sub-division do you want for spe. heat=?'
read(*,*)ndiff
write(*,*)'large guess for specfic heat (ie. cw(ndiff+1))=?'
read(*,*)cw(ndiff+1)
write(*,*)'ntime(total testing time(sec)*5 ie.(300sec.=1500)=?'
read(*,*)ntime
write(*,*)'ne(total testing time(seconds) *frequency)=?'
read(*,*)ne
write(*,*)'iskip(time*frequency,ie. 6sec.s=30)=?'
read(*,*)iskip
write(*,*)'nterms(# of eigenvalues)=?'
read(*,*)nterms
write(*,*)'a(diff. of wood)=?'
read(*,*)a
write(*,*)'row(density of wood)=?'
read(*,*)row
open(3,file='data',status='old')
do 170 j=1,ne
read(3,*)ts(j),tempes(j)
170 continue
endfile(3)
close(3)
icount=0

```

```

write(*,*)'          Time          Temperature'
do 100 j=1,ne,iskip
icount=icount+1
t(icount)=ts(j)
tempe(icount)=tempes(j)
100 write(*,*)t(icount),tempe(icount)
continue
write(*,*)'total points selected= ',icount
t0=tempe(1)
b=pkpa/(sip*gamp)
write(*,*)'t0= ',t0,' b(diff. of plexiglas)= ',b
c initialization
ta=sqrt(a)
tb=sqrt(b)
aa=x11/ta
bb=x12/tb
cwin=cw(1)
cwlast=cw(ndiff+1)
delcw=(cw(ndiff+1)-cw(1))/real(ndiff)
write(*,*)'specific heat increment = ',delcw
do 140 i=2,ndiff
140 cw(i)=cw(1)+(cw(ndiff+1)-cw(1))/real(ndiff)*real(i-1)
c compute the sum of squared error between experimental data
c and mathmodel
write(*,*)'          specific heat          total error '
open(5,file='err',status='old')
write(5,*)'specific heat total error'
do 110 ia=1,ndiff+1
cwerr(ia)=0.0
xkk=a*row*cw(ia)/pkpa
cc(ia)=xkk*tb/ta
c get the required roots
call roots(aa,bb,cc(ia),nterms,result)
do 50 j=1,icount
call tcalc(a,b,cw(ia),row,sip,gamp,x11,x12,t0,t1,nterms,
$t(j),result,temp)
cwerr(ia)=cwerr(ia)+(temp-tempe(j))**2
50 continue
cwerr(ia)=sqrt(cwerr(ia))
write(*,*)cw(ia),cwerr(ia)
write(5,*)cw(ia),cwerr(ia)
110 continue
close(5)
c sort cwerr in ascending order(bubble sort)
120 if(switch.eq.1)then
switch=0
do 230 k=2,ndiff+1
if(cwerr(k).lt.cwerr(k-1))then
sterr=cwerr(k)
cwerr(k)=cwerr(k-1)
cwerr(k-1)=sterr
storec=cw(k)

```

```

        cw(k)=cw(k-1)
        cw(k-1)=storec
        stcc=cc(k)
        cc(k)=cc(k-1)
        cc(k-1)=stcc
        switch=1
    end if
230  continue
    goto 120
end if
c calculate thermal conductivity of wood
    wk=a*row*cw(1)
    write(*,*)'wk(thermal conductivity of wood ',wk
c write result in file tempm
    open(4,file='tempm',status='old')
    write(4,*)'t0( deg c) t1( deg c) density(kg/m3) '
    write(4,*)t0,t1,row
    write(4,*)'ne nterms a(diffusivity) '
    write(4,*)ne,nterms,a
    write(4,*)'cwin(small guess) cwlast(large guess)'
    write(4,*)cwin,cwlast
    write(4,*)'cw(specific heat) wk(thermal conductivity of wood)'
    write(4,*)cw(1),wk
    call roots(aa,bb,cc(1),nterms,result)
    do 210 i=1,ntime
        t(i)=.2*real(i)
        call tcalc(a,b,cw(1),row,sip,gamp,xl1,xl2,t0,t1,nterms,
        $t(i),result,temp)
        tempm(i)=temp
        write(4,90)t(i),tempm(i)
210  continue
90  format(f6.2,f15.6)
    endfile(4)
    close(4)
    stop
end

```

```

c ////////////////////////////////////////////////////////////////////
//

```

```

    subroutine tcalc(a,b,cwt,row,sip,gamp,xl1,xl2,t0,t1,nterms,
    $time,result,temp)

```

```

c ////////////////////////////////////////////////////////////////////
//

```

```

c This routine computes the temperature at the midpoint
c of the block for specific material parameters at a
c particular time.
c

```

```

c On input (argument list):

```

```

c     a      = Conduction coefficient of the plexiglass,
c             [sq m/sec].

```

```

c     b      = Conduction coefficient of the wood,

```

```

c          [sq m/sec].
c      row    =density of wood [kg/cu. m]
c      sip    =density of plexiglas [kg/cu. m]
c      cwt    =specific heat of wood [J/kg deg C]
c      gamp   =specific heat of plexiglas [J/kg deg C]
c      time   = Time [sec].
c      result = Array containing the modified roots computed
c              for the same material parameters by routine
c              ROOTS.
c
c      x11    = Length of the wood layer [m].
c      x12    = Length of the plexiglass layer [m].
c      t0     = Initial (equilibrium) temperature [deg C].
c      t1     = Platen temperature [deg C].
c      nterms = Numbers of terms to be used in the series.
c
c      On output:
c      temp    = Computed temperature [deg C].
c
c'////////////////////////////////////
c'////////////////////////////////////
c      dimension result(50)
c
c      initialize the sum
c      sum=0.0
c      ta=sqrt(a)
c      tb=sqrt(b)
c      now compute the sum in series
c      do 40 i=1,nterms
c          rts=result(i)
c          s1=sin(x11*rts/ta)
c          t2=cos(x12*rts/tb)
c          cnum=cwt*row*ta*t2/rts
c          cdeno=cwt*row*x11*t2*t2+sip*gamp*x12*s1*s1
c          coef=2.0*(t0-t1)*cnum/cdeno
c          sum=sum+coef*s1*exp(-rts*rts*time)
40      continue
c      sum=sum + t1
c      temp=sum
c
c      return
c      end
c
c'////////////////////////////////////
c'////////////////////////////////////
c      subroutine roots(aa,bb,ccc,nterms,result)
c'////////////////////////////////////
c'////////////////////////////////////
c      This routine computes the first several roots of the
c      expression
c

```

```

c      (*)          ccc = tan(aa*x)*tan(bb*x)
c
c      where ccc=xkk*tb/ta=a*row*cw(i)/pkpa*tb/ta
c              aa=x11/sqrt(a)
c              bb=x12/sqrt(b)
c              x=elam(ie. eigenvalues)
c      using a slow-but-sure linear search followed by a bisection
c      root-finding. The expression used for computations is
c      actually cc*cos(aa*x)*cos(bb*x) = sin(aa*x)*sin(bb*x).
c
c      On input (argument list):
c          aa,bb,ccc = Parameters as described above.
c
c          nterms   = Numbers of roots to compute(maximum=50).
c          ict      = Numbers of roots which we calculated
c
c      On output:
c          result   = Array containing the first nterms roots.
c      ////////////////////////////////////////////////////
c      ////////////////////////////////////////////////////
c
c          dimension result(50)
c          data con1,niter/0.05,25/
c      initialization
c          pi=4.0*atan(1.0)
c          tmp=max1(bb/aa,aa/bb)
c          xstep=con1*pi/2.0*ccc/(ccc*tmp + 1.0)
c          xb=0.0
c          fb=ccc
c          ict=0
c
c      10      continue
c      search for sign changes in (*)
c          xa=xb
c          fa=fb
c          xb=xa + xstep
c          taa=aa*xb
c          tbb=bb*xb
c          fb=ccc*cos(taa)*cos(tbb) - sin(taa)*sin(tbb)
c          if(fa*fb .gt.0.0 )go to 10
c
c      found a sign change...xa and xb straddle the root(using bisection)
c      maximum iteration =25
c          ict=ict + 1
c          x1=xa
c          f1=fa
c          x2=xb
c          f2=fb
c          do 20 i=1,niter
c              xm=0.5*(x1 + x2)
c              if((x2-xm).lt.0.000001)goto 30
c              taa=aa*xm

```

```
tbb=bb*xm
fm=ccc*cos(taa)*cos(tbb) - sin(taa)*sin(tbb)
if(f1*fm .gt.0.0)then
    x1=xm
    f1=fm
else
    x2=xm
    f2=fm
endif
20  continue
30  result(ict)=xm
    if(ict .lt. nterms)go to 10
c  write eigenvalues on file eigen
    open(33,file='eigen',status='old')
    write(33,*)'      order      eigenvalues'
    do 140 i=1,nterms
140 write(33,*)i,result(i)
    endfile(33)
    close(33)
    return
end
```