

NOV 16 1951

371.42
Or31cl
no. 77
1951
c.3

DOCUMENT
COLLECTION
OREGON
COLLECTION

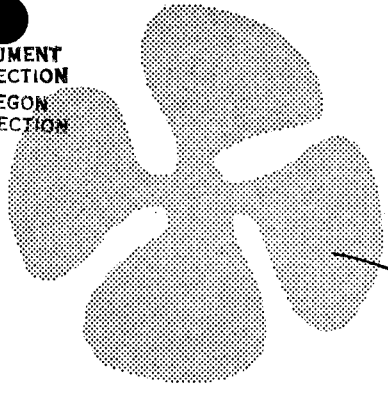

it's fun

4-H Clothing Project
Club Series L 77

• sew • • • •

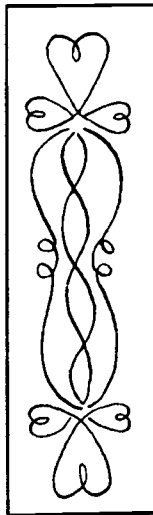

DISCOVER

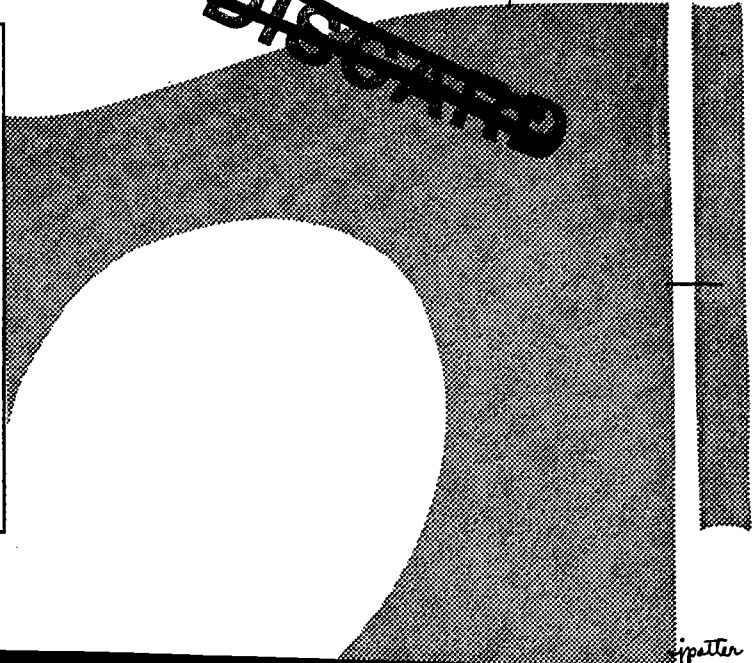

Federal Cooperative Extension Service
Oregon State College
Corvallis

ippeter

Cooperative Extension Work in Agriculture and Home Economics, F. E. Price, director. Oregon State College, the United States Department of Agriculture, and the State Department of Education co-operating. Printed and distributed in furtherance of the Acts of Congress of May 8 and June 30, 1914.

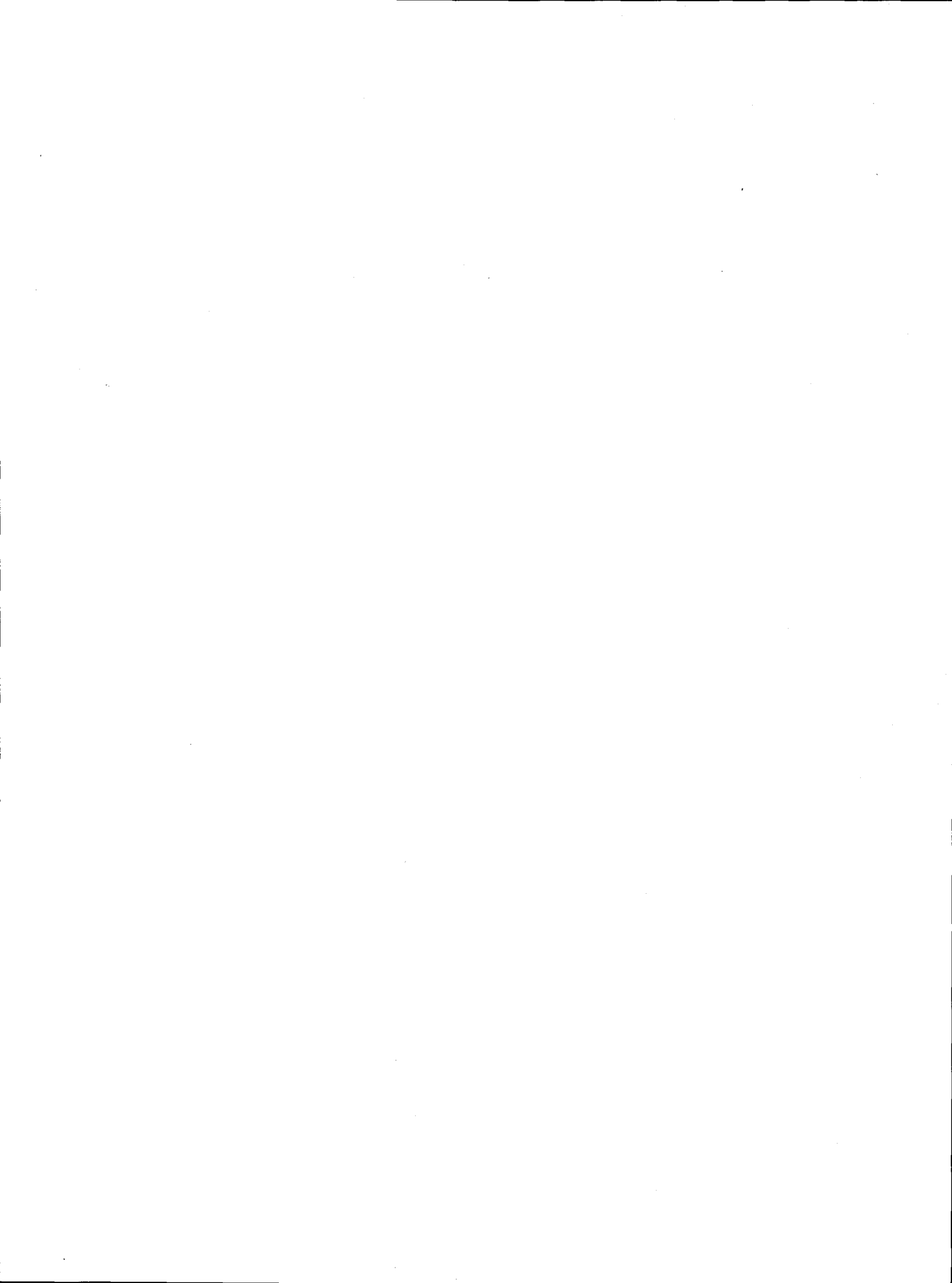
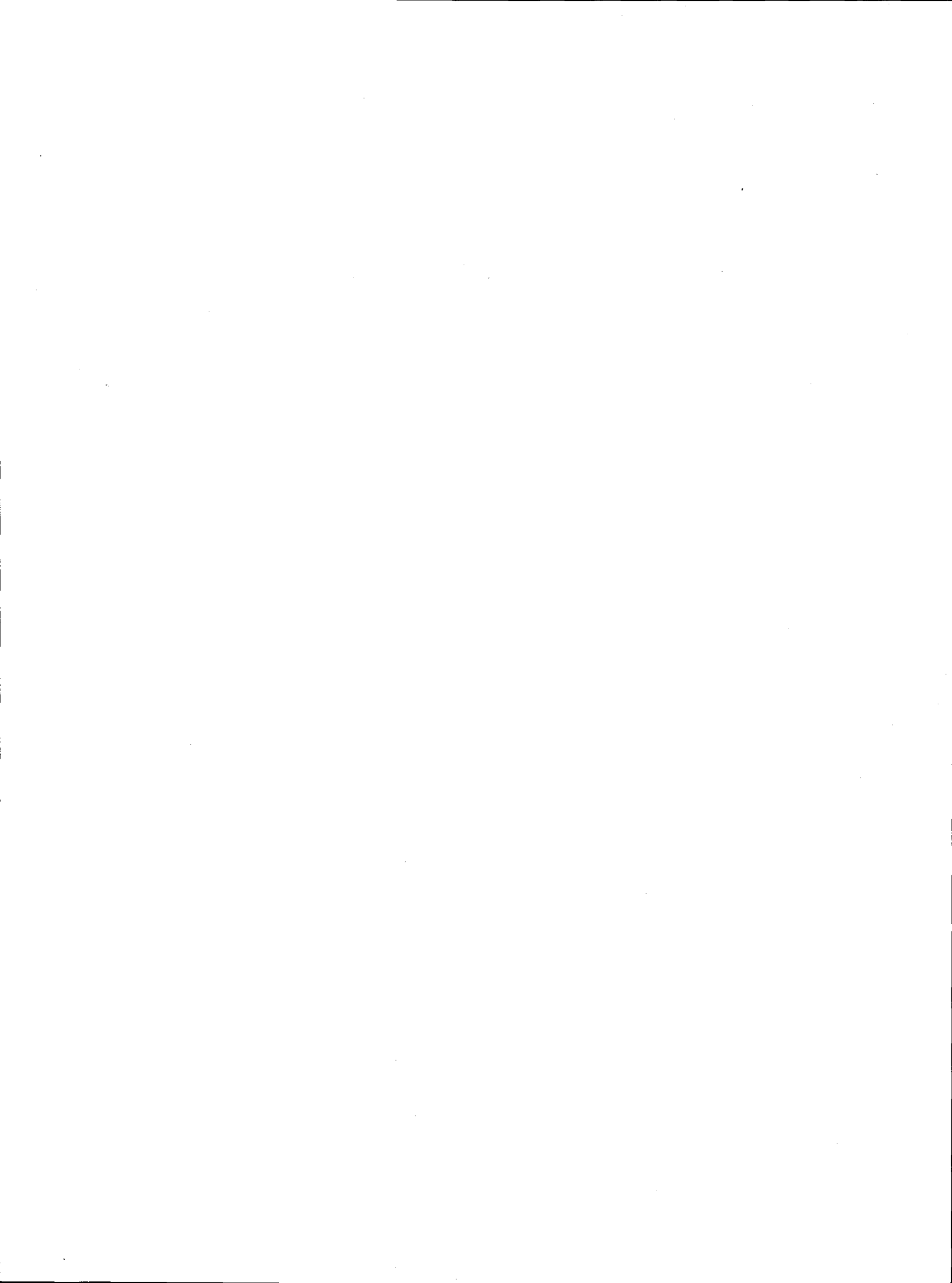

Table of Contents

	Page
Introduction	5
The Sewing Machine	5
Parts of the machine	5
Running the machine	6
Learning to stitch	7
Head Scarf	9
Sew on Buttons	10
Pot Holder	12
Preparing and cutting fabric	13
Put in padding	13
Finish sides and corners	13
Make loop	14
Quilt pot holder	15
Plastic ring	16
How Graceful Are You?	16
How do you stand?	16
How do you walk?	18
Do you take your stairs like a lady?	18
Sitting pretty?	19
Drawstring Apron	20
Selecting the fabric	20
Shrinking cotton fabric	24
Straightening the fabric	26
Making the apron	26
Thinking of Others	31
Entertain mothers	31
Repair toys	31
Make child's book	31



SEW! IT'S FUN

MURLE SCALES, Clothing Specialist
OREGON STATE COLLEGE
EXTENSION SERVICE
CORVALLIS, OREGON

Sew! It's fun. It's fun to sew by hand, and it's fun to sew on the sewing machine.

Too, it's fun learning those little things that make a girl so charmingly graceful while wearing the lovely apron created by your own hands.

It's fun to do things for others and to entertain for your mothers.

So, let's have fun in this project.

The Sewing Machine

You have been looking forward to the time when you could run your mother's sewing machine. At last the time has come. Before your next 4-H Clothing meeting you will need to know how to sew on the machine.

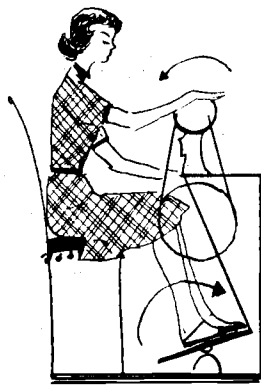

Figure 1.

Parts of the machine

It will be easier for your mother to teach you to run the sewing machine if you know something about the parts. This year you will learn the parts that you need to use. Next year you will learn more of them.

Look at the illustration and locate the labeled parts. Now locate these on your machine. Your machine may not be exactly like this, but it will be very similar.

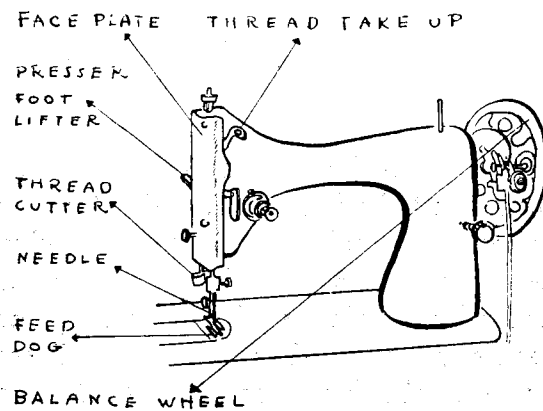

Figure 2.

Before starting to learn how to use the machine, ask your mother to unthread it and put the presser foot up.

Running the machine

Treadle machine

Get seated comfortably at the machine. Place your feet on the treadle about 4 inches apart with one foot ahead of the other.

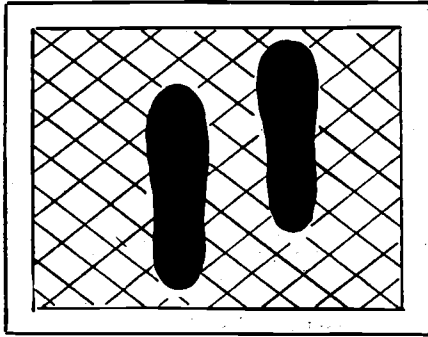

Figure 3. Foot treadle.

Turn the balance wheel—some machines turn forward and others backward. Be sure to turn it the right direction for your machine.



Figure 4.

Did you feel the treadle move when you moved the balance wheel? Get the feel of the machine. Now start moving the treadle with your feet. Take your hand off the balance wheel and keep the treadle going with your feet. Press first with the foot that is forward, then with the foot that is slightly back. You may have difficulty keeping the machine running smoothly. Keep practicing until you can run it smoothly and slowly. It is easier to run it faster, but

a seamstress must learn to run it slowly and smoothly.

Stop the machine by placing the right hand gently on the balance wheel, stopping it as you slowly stop treading. You will want to practice this for several days.

Electric machine

If you are using an electric sewing machine, you will need to learn to start and stop the machine and how much pressure to use on the foot or knee control to keep the machine running smoothly.

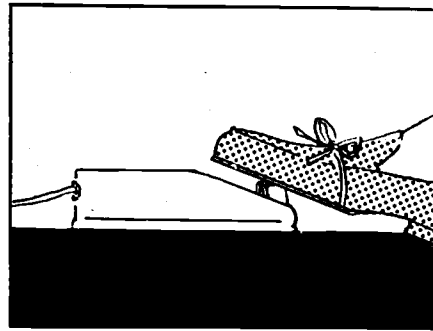

Figure 5. Electric foot feed.

WARNING: Remember there is a lot of power in an electric machine! Keep your foot or knee away from the

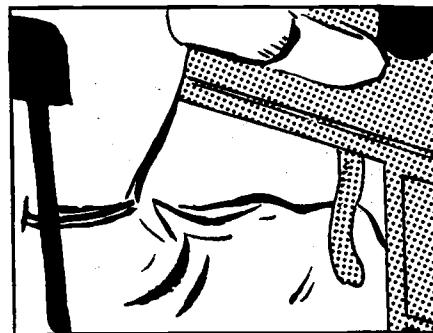

Figure 6. Knee control.

control when your hands are near the needle. Keep your hands at a safe distance from the needle when you are

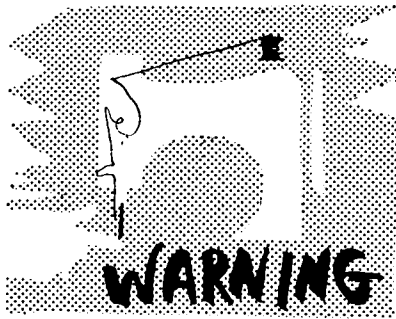

Figure 7. Keep your foot or knee away from control when your hands are near the needle.

stitching with either an electric or treadle machine.

Note: Study the instruction book that came with the machine and learn other parts of the machine.

Learning to stitch

Now that you can run the machine smoothly and evenly, you are ready to learn to stitch. You will do your first stitching on paper without any thread.

Take a piece of ruled paper. Place the right side of the paper under the presser foot. The larger part of what you are sewing should always be to the left of the presser foot when you start. Turn the balance wheel until the needle goes through the paper exactly at the end of the first line. Lower the presser

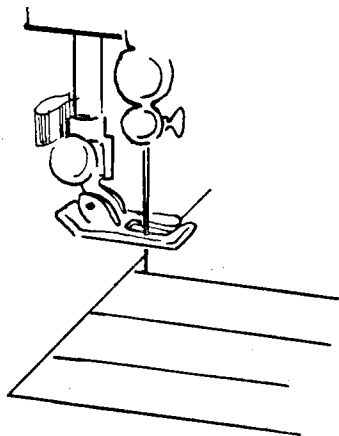

Figure 8.

foot lifter (the little lever at the back). Slowly start stitching on this line. Place a hand on either side of the paper and slowly guide it under the needle. You may not be able to follow the first line too well. Keep trying. Practice makes perfect. You will be rewarded with a very straight row of stitching. When you stop, always turn the balance wheel until the needle is as high as it will go.

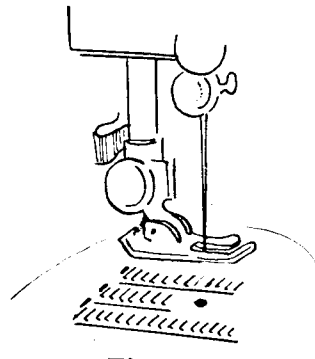

Figure 9.

On another sheet of paper draw lines to make square corners. Start stitching as you did before. Stop stitching when you reach a corner. Leaving the needle in the paper, lift the presser foot and turn the paper so that you can follow the line down the other side. Lower

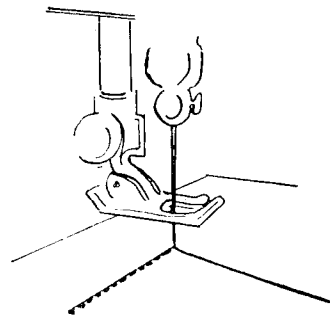

Figure 10.

the presser foot and begin stitching again. Stitch all of the lines and turn all of the corners in the same way.

After this practice you should be able to run a machine fairly well. Your mother may thread the machine for you and you can practice sewing on a double thickness of material. Watch your mother, for you should soon be able to thread the machine without her help.

Before starting to sew, get the bobbin and top thread out of the way by this method. Take the thread that comes from the needle in your left hand. With your right hand on the balance wheel (but feet NOT on the treadle) turn the wheel so that the needle goes down and comes up once. Be sure to turn the balance wheel the right direc-

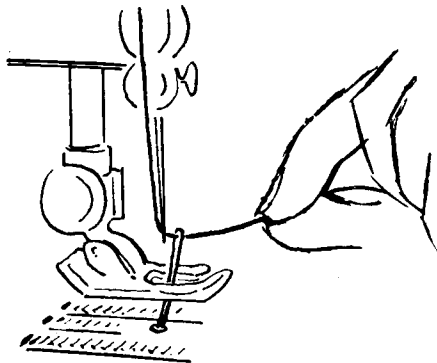

Figure 11.

tion for your machine. Gently pull the thread. You will see a loop in between the toes of the presser foot. This is the thread from the bobbin. Pull it out and

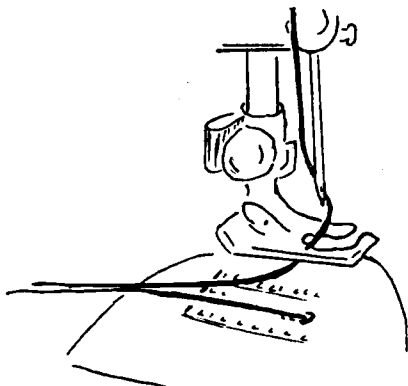

Figure 12.

place both threads to the back out of the way.

Place the material under the presser foot. Turn the balance wheel until the needle is in the cloth. Lower the presser foot. Now start sewing.

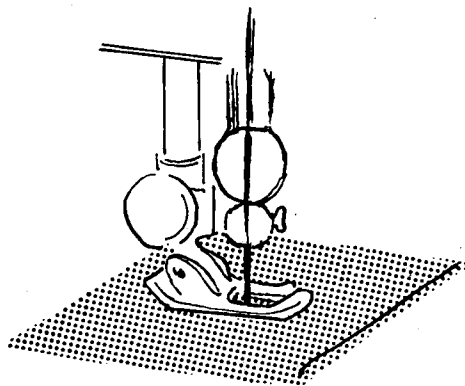

Figure 13.

While stitching, guide the fabric under the presser foot by gently placing the hands on the fabric as shown and pushing it toward the needle. Never pull the fabric at the back of the presser foot while stitching.

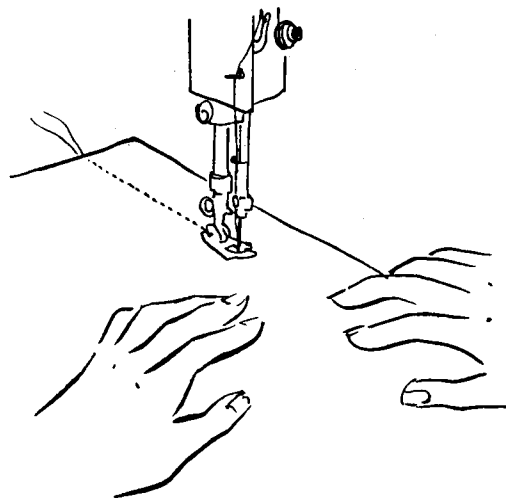

Figure 14.

When you have finished sewing, again raise the needle bar as high as possible and pull the material to the back of the machine. Notice that the

top thread remains between the toes of presser foot. See Figure 15. This is done to prevent bending the needle. Use the cutter at the back of the machine to

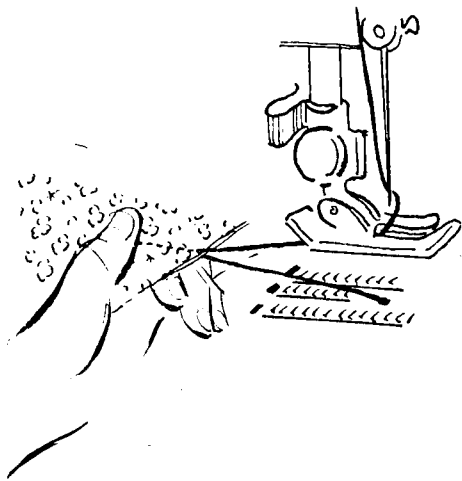

Figure 15.

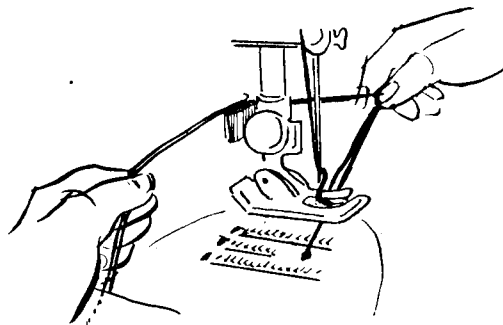

Figure 16.

cut the thread. This saves time and effort in picking up scissors.

Continue to practice stitching on cloth until you are quite sure you know how to stitch and can stitch fairly straight. Then you are ready to make something on the machine.

Head Scarf

How about a new head scarf? Wouldn't you like to make one using the sewing machine? Too, you have a few new clothes this year, so it will be nice to have another head scarf to wear with them.

Look at the "Just So Girl" clothing book you had last year. Review all the things you learned about making a head scarf, such as selecting and straightening the material. Also review how to draw two threads 1 inch from the edge around all sides of the scarf. Do exactly the same things up to the point where you hand stitched.

This time, stitch on the machine instead of sewing the head scarf by hand. This is done the same place on the scarf as the hand stitching, except you stitch around the entire head scarf where you drew the threads. Remember how to turn corners? Ask your mother to regu-

late the machine so there are about 16 stitches to the inch.

Some machines have a regulator that shows the number of stitches to the inch. If your machine doesn't have the regulator, you may find out the number of stitches in the following manner: Sew a line of machine stitching. Measure one inch of the stitching and place a pin. Take another pin to point to the stitches as you count them. This makes

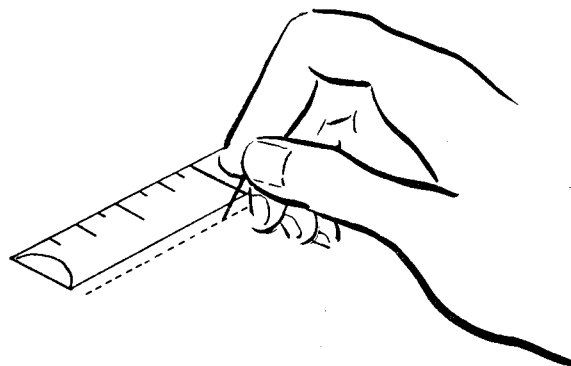

Figure 17.

it a little easier to count accurately. If you count 16 stitches in the one-inch space, the machine has been regulated to make 16 stitches to the inch.

Sew slowly so that your sewing will be exactly where you pulled the threads. Do not start or stop at a corner. Turn corners as you have learned. When you

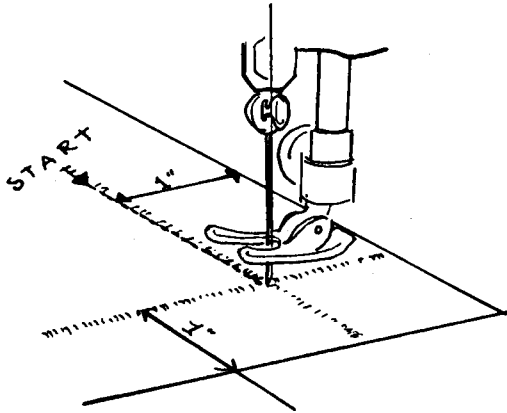

Figure 18.

have stitched all the way around, overlap the stitches for five or six stitches to fasten the thread. Then tie the threads.

Fringe the sides of the scarf by pulling out the threads between the stitching and the edge. Pull those on the edge of the material first and work up to the machine stitching. Refer to your last year's clothing bulletin, "Just So Girl."

Score sheet for head scarf:

1. Is the stitching smooth and even, with the cloth not puckered or drawn?
2. Are the stitches the correct length for the fabric?
3. Is the stitching straight?
4. Is the scarf well pressed with the fringe smooth and even?
5. Are the corners neat and turned correctly?
6. List the things that should be improved on your next head scarf.

.....

.....

.....

Sew on Buttons

Last year you learned to care for your clothes by keeping them hung up neatly in the clothes closet. You also learned to fold your sweaters correctly and place them in a drawer or on a shelf.

Of course, you have done the above so long now that you do it without thinking. So, you will continue to hang up your clothes and fold your sweaters but will want to do something more to care for your clothes.

Wouldn't you like to learn to sew on buttons that have come off your clothes? It will be nice to do it for

yourself and not depend on your mother to do it for you.

This is a good way to sew on the buttons so that they will stay on for a long time.

► Mark the position of the button this way. Lap the edges of the garment properly and pin into position. Mark the exact position of the button with a pin stuck through the finished button-hole. The center of the button usually comes about $\frac{1}{4}$ inch

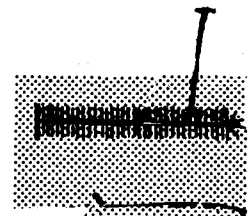

Figure 19.

back from the edge of the buttonhole, as shown.

► Use a double thread so that you will not need to make so many stitches. Fasten the thread by taking several small stitches on the right side where the button is to be placed.

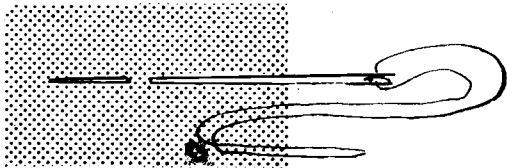

Figure 20.

► Put the needle through one hole in the button, back through the other hole and through the cloth to the wrong side.

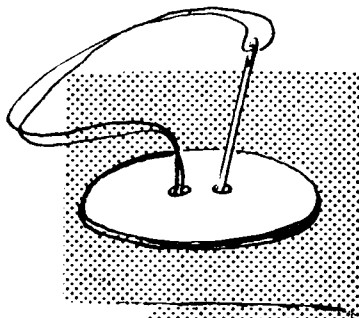

Figure 21.

► Place a pin under the stitch. Sew over the pin and down through the cloth three or four times.

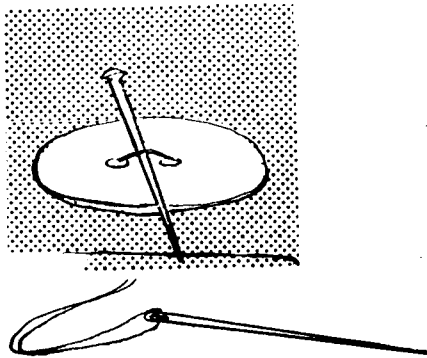

Figure 22.

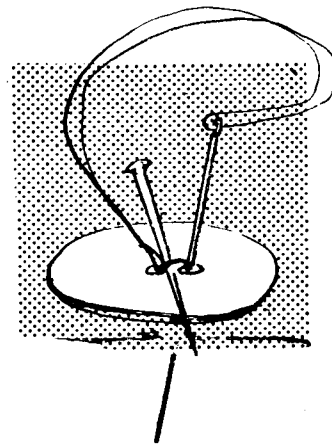

Figure 23.

► Bring the needle up through one hole of the button and down through the second, but not through the cloth.

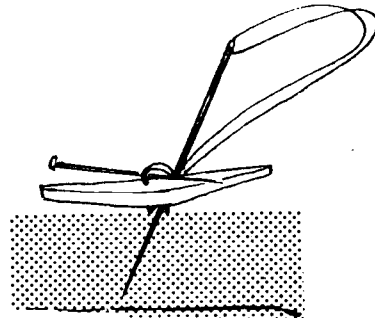

Figure 24.

► Remove the pin. Pull up the button as far as the slack will let it come.

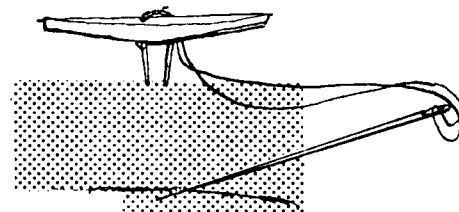

Figure 25.

► Wrap the thread from the needle around this slack several times without putting the needle through the cloth.

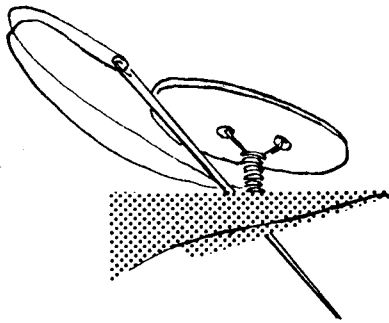

Figure 26.

Start wrapping near the button and continue until the wrapping thread meets the cloth. This is called making a "shank" for the button. Most buttons are sewed on with a shank so that the buttonhole will lie flat and not pucker when it is buttoned. Too, buttons are less likely to pull the cloth and tear out.

► Bring the needle to the wrong side, putting it through the cloth close to the shank. Take three little stitches on the wrong side in the same place to fasten the thread.

Pot Holder



Figure 27.

When you make the drawstring apron which comes later, you will probably wish to buy enough material for a pot holder to match. If you are not quite ready to make the drawstring

apron, you may want to make a pot holder to be used now. Choose a cover material which is firm and strong, and a color which blends with the colors in your kitchen. You may make the outside cover of feed sacks. For the padding, use old outing flannel or layers of soft cotton fabric. Parts of an old pair of outing flannel pajamas or a soft feed sack are excellent.

You may even want to make several pot holders before you make that nice one to match your apron. It's fun to sew on the machine, and the more you practice sewing, the easier it will be to do a good job of making the apron. Sew and sew. It's fun!

Be sure to use thick enough padding to protect the hands from hot pans, but not so thick that the pot holder is stiff and hard to use. If you wish, you may make a different shape or size from the one suggested here, but make it large enough to protect the hands. Seven inches square is a good size.

Preparing and cutting fabric

Here are the steps in making a very simple pot holder:

- ▶ Press the fabric and padding if it is wrinkled. It is easier to do a good job and to cut straight if it is pressed.
- ▶ Carefully measure the cover 8 inches wide and 15 inches long. Pull threads to be sure that you are cutting accurately.

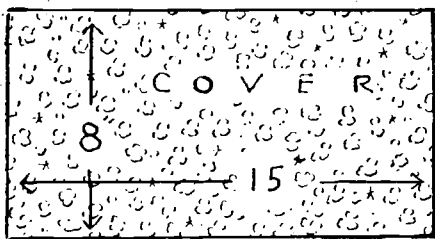

Figure 28.

- ▶ Get 3 inches of $\frac{1}{4}$ -inch twill tape or a plastic ring for the loop to use in hanging the pot holder.

- ▶ Measure the padding 7 inches wide and 14 inches long. Again pull threads. This makes the padding exactly 1 inch shorter and 1 inch narrower than the cover. Usually two layers of padding, such as feed sacks, are enough. When folded in the finished pot holder, it will give four thicknesses.

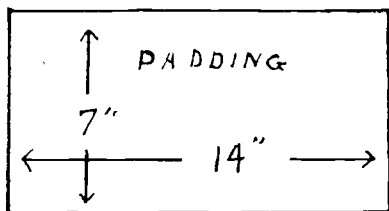

Figure 29.

Put in padding

- ▶ Put the cover on the table wrong side up. Place the two or three layers of padding inside so that there is $\frac{1}{2}$ inch of the cover extending out on all four

sides. Pin the layers of padding and cover together.

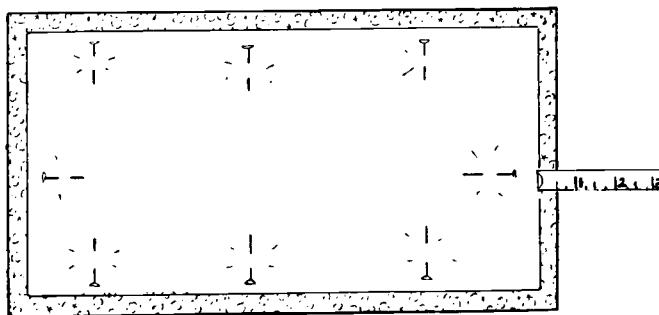

Figure 30.

- ▶ Keep the cover and padding as flat on the table as possible to prevent the padding from slipping out of place. Baste the padding and cover together with long basting stitches. Keep smoothing the padding as you baste.

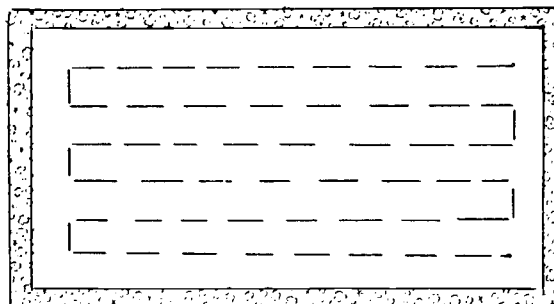

Figure 31.

Finish sides and corners

- ▶ Turn the corner of the cover over on the padding as shown here.

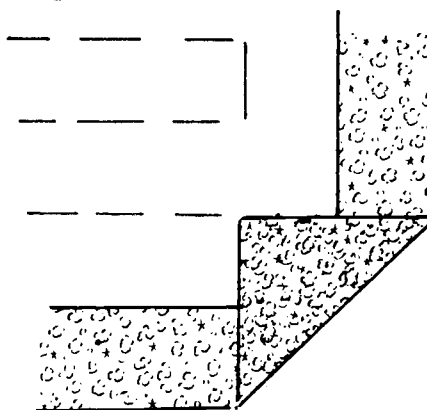

Figure 32. Turn corner.

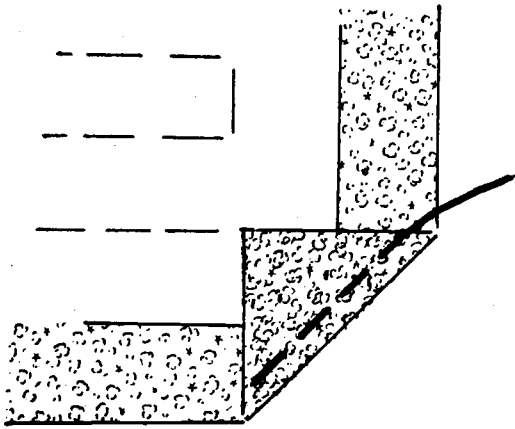

Figure 33. Baste across corner.

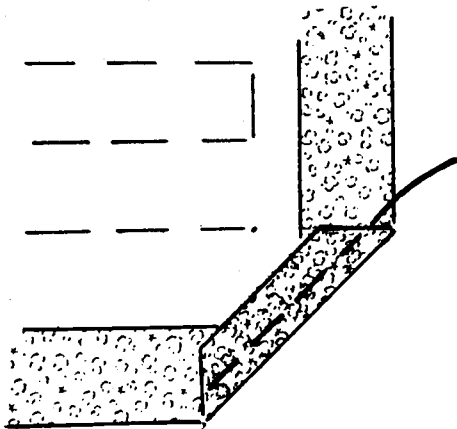

Figure 34. Trim off point.

► Fold the cover over the edges as shown below, and baste.

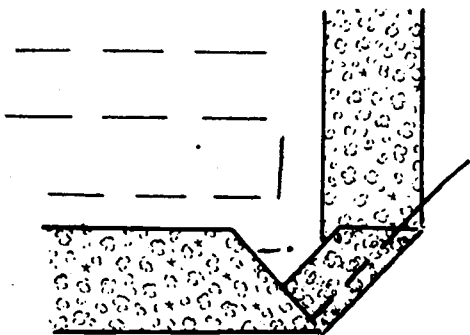

Figure 35. Fold cover over edges.

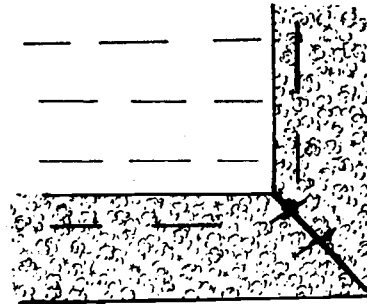

Figure 36. Cover pinned and ready to baste. Edges basted.

Make loop

Make a loop to hang the pot holder if you are not using the plastic ring.

► Fold a 3-inch length of twill tape through the center lengthwise and baste. Stitch the two edges together and press. Then stitch on the fold to make the loop stronger.

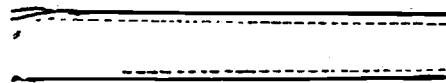

Figure 37.

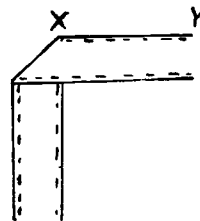

Figure 38.

► Fold the tape so that X is the center of the tape.



Figure 39.

► Hold this fold in position and bring Y next to Z.

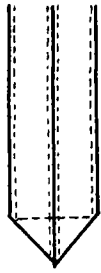

Figure 40.

► Stitch across the end of the point as shown. This is the way the loop looks on the other side after it is stitched.

► Place the loop in the center of one side of the pot holder. Baste into position. Be very careful to have the loop placed straight so that the pot holder will hang straight. The loop will be stitched to the pot holder as you stitch the pot holder together.

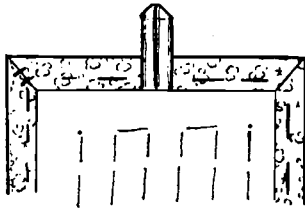

Figure 41.

Quilt pot holder

► Fold the pot holder together across the center so that the edges meet evenly on all sides. Pin, then baste together.

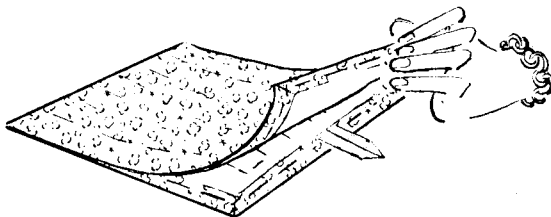

Figure 42.

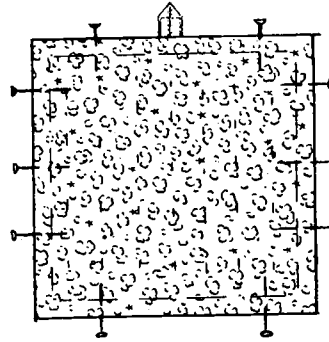

Figure 43.

► Press.

► Machine stitch between 1/8 and 1/6 inch from the edge. Be sure to catch both sides in the stitching.

Note: If the padding is very thick, you may have to ask your mother or club leader to regulate the machine for a longer stitcher.

► Quilt any design you wish. Here are a few suggestions. Tie your threads each time you stop stitching, or sew back over the stitching for 1/2 inch.

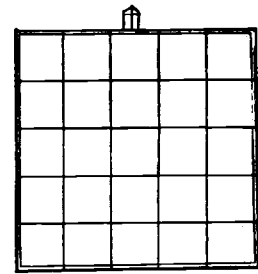
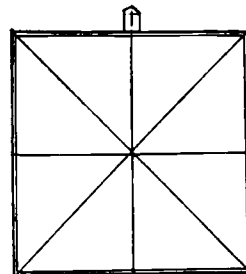
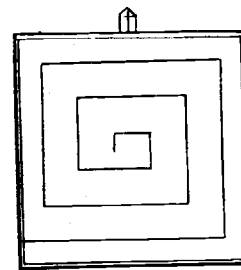

Figure 44.

Plastic ring

► If you are using the plastic ring to hang the pot holder, attach it at the corner with a blanket stitch. Refer to the directions used in making the blanket stitch for the needle case, page 16 of "Just So Girl." The plastic ring is sewed to the holder after the pot holder is quilted.

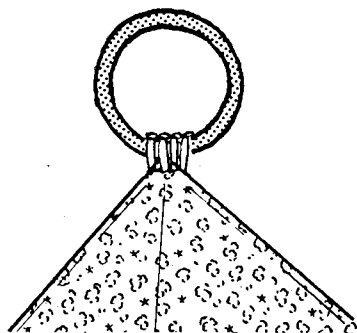

Figure 45.

Score sheet for pot holder:

1. Are sides and corners well squared (if a square holder)?

2. Are sides turned under evenly?
3. Is the first row of stitches near the edge with both edges caught around the entire holder?
4. Are all rows of stitching straight and spaced evenly?
5. a. Is the loop hanger stitched evenly and placed in the side straight?
- b. Is the blanket stitch on the loop even?
6. Are there any puckers between stitching lines?
7. Does it have the right amount of thickness, not stiff and harsh, but sufficient to protect the hands?
8. Is it well pressed?
9. List the things that need to be improved on your next pot holder.

.....
.....
.....

How Graceful Are You?

Are you sometimes tempted to sit on the middle of your back with your feet thrown over the side of an armchair and your head pillowed against the other arm? You may think that you are comfortable, but it really doesn't make you look very pretty! Look at the pictures of the models in one of your mother's magazines. Notice how gracefully they sit with knees close together and with one foot slightly forward.

Take a good look in a full-length mirror, if you have one (or maybe you can use a store window someday when the sun is just right), and notice how you carry yourself. How do you think you

look to other people? Is your back straight and your tummy in?

Learning correct posture and how to be graceful is something you'll never regret. All your life you'll be most grateful for having learned something of charm and poise in your 4-H Club. For if you learn it well, your friends will say of you, "How graceful she is."

How do you stand?

To acquire grace, one must start by getting the body lined up in the correct position. Many girls have slumped forward so long that they do not know exactly when they have a correct stand-

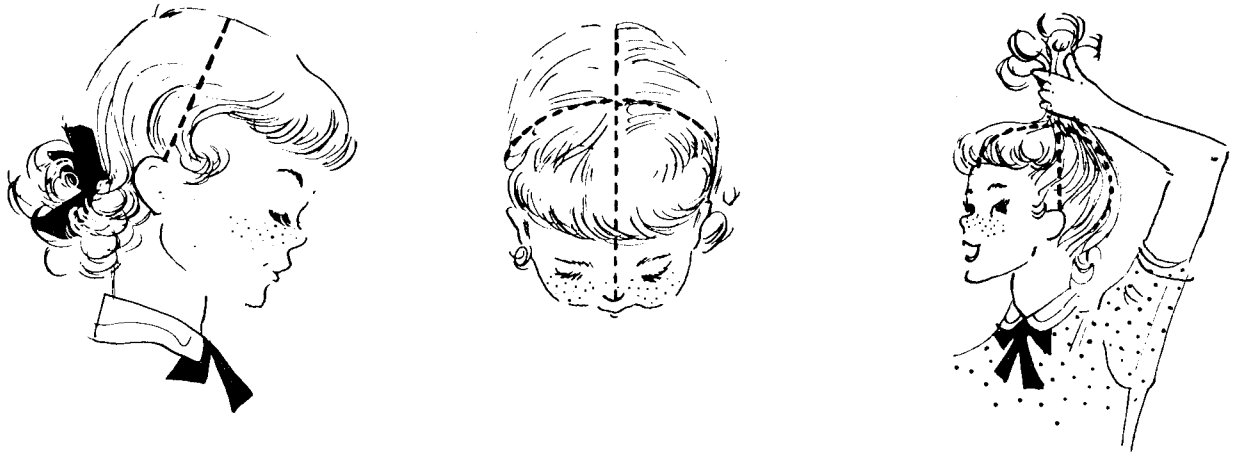

Figure 46.

ing position. Maybe you have been told to straighten up as if you had a string attached to the top of your head. You can really get this feeling by the following method.

- ▶ Trace a line with your finger from the lobe of the ear to the top of the head.

- ▶ Trace another line with your finger from the tip of the nose to the top of the head.

- ▶ At the point where these two lines cross, grasp a handful of hair and pull up. It is better to have someone else pull the hair for you. As the hair is pulled up straight, it will force you to pull in your tummy and straighten the body as it should be straightened. You should be lined up as shown in the drawing with the lobe of the ear, the tip of the shoulder, hip bone, knee bone, and ankle bone in one straight line. Do not hold yourself in a rigid position, but be relaxed.

Keeping that position, walk about the room. Practice this many times a day for several weeks. You will be pleasantly surprised at your improved posture!

Always stand with your feet at an angle so that one heel is about even

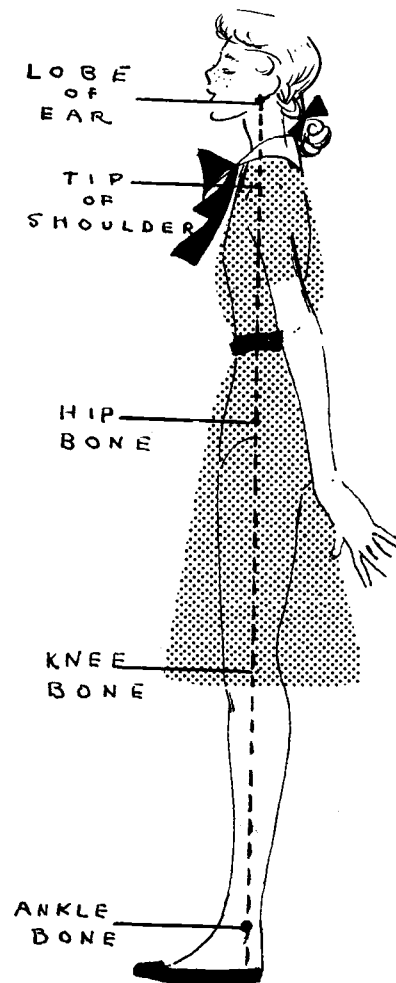
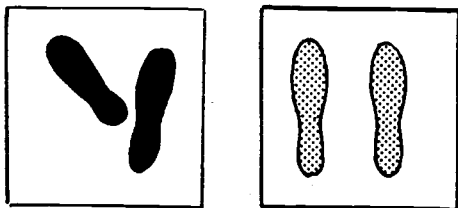

Figure 47.

with the instep on the other foot. Standing with both feet pointing forward produces an awkward position. Look at fashion magazines. The figures always stand with the feet close together and at an angle.



This

Not this

Figure 48.

How do you walk?

Check on your walking. Your feet should be about $2\frac{1}{2}$ inches apart. Keep your toes pointed straight ahead as if you were walking on two straight lines.

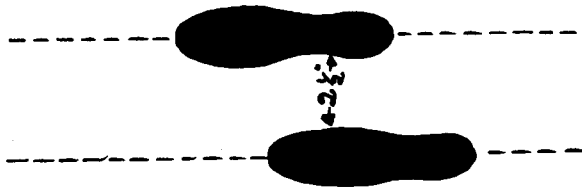

Figure 49.

This helps you in holding your hips firm and produces a smooth, even walk. If you walk with your feet much farther apart, you will swing your hips in a most ungraceful manner.

What size step?

For most girls the length of your foot is about the right size step. It will vary some with your height. However, this is a fair guide.



Figure 50.

Walk with an easy motion, swinging the legs from the hips and with the

knees slightly bent and relaxed. The arms may swing easily at the side. As you step forward with one foot the opposite arm is swung forward. Thus, in stepping out with the right foot the left arm would swing forward. Then the left foot and right arm would swing forward. The arms should never be allowed to swing any farther forward than the foot. This is all done with an easy swinging motion, your chin up and your body in line.

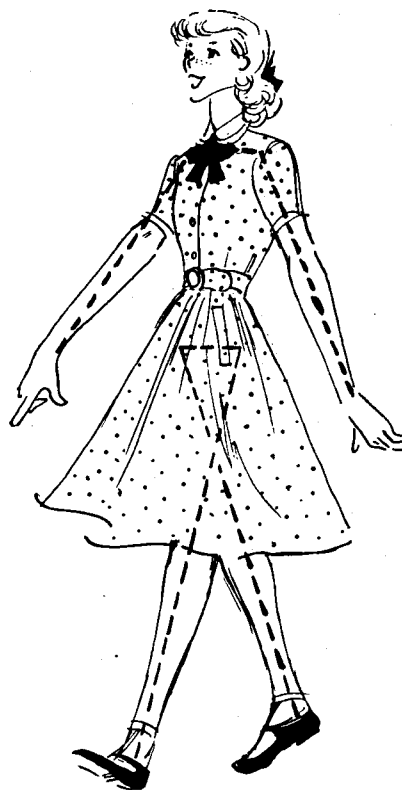
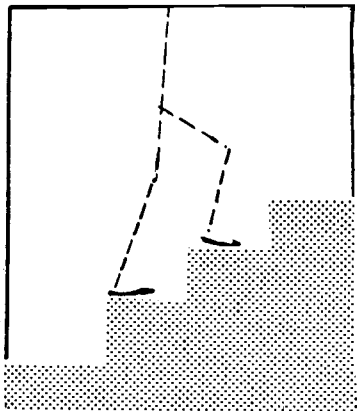

Figure 51.

Do you take your stairs like a lady?

► Be sure that you place your entire foot squarely on each step. Do not try to walk up the stairs with just the toes on the step. This is the cause of many accidents.

► Lean very slightly forward from the ankle with knees very slightly bent.



This

Lean forward from the ankle . . . knees always slightly bent.

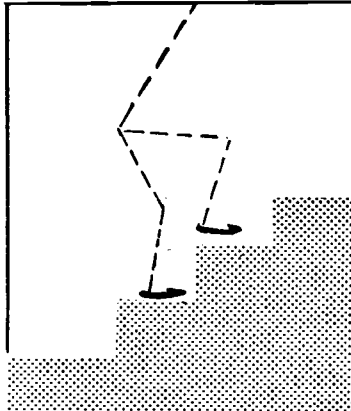

Not this

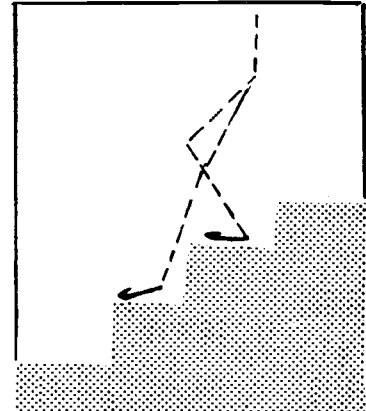

Coming down

Lean back from the ankle . . . knees slightly bent.

Figure 52.

► In coming down the stairs lean very slightly back from the ankle with the knees very slightly bent. You should appear to glide up and down the stairs without your head bobbing up and down with each step. When you go to a movie, watch your favorite actress go up and down stairs and see how gracefully she does it.

Sitting pretty

Are you sitting pretty like Figure 53 or do you sit like Figure 54? Keep the body straight and bend the knees to sit.

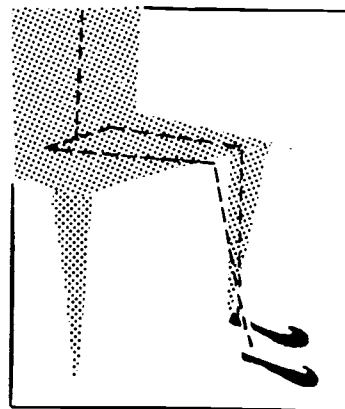

Figure 55.

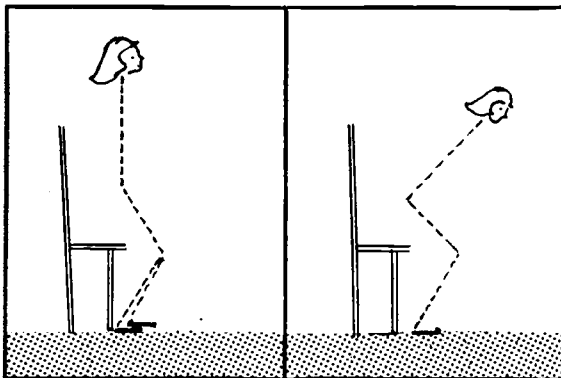

Figure 53. This. Figure 54. Not this.

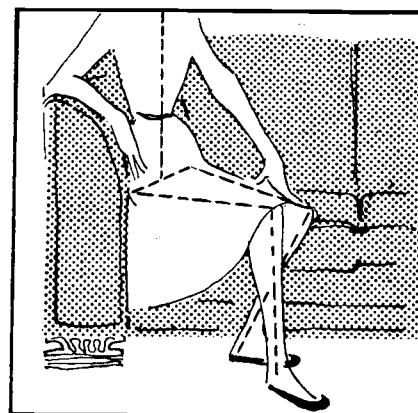

Figure 56.

If one foot is slightly ahead of the other and more weight is put on it, you will be able to lower yourself into the chair with the greatest of ease. Of course, it will take muscle control.

Always sit with your knees and feet close together. If you are small, you will find it more comfortable to sit at the corner of the couch using the arm of the couch as a back rest.

You will not find it necessary to smooth your dress with your hands as

you sit in a straight chair if you sit down this way. When you lower yourself into the chair, sit on the edge and slide back into the chair. As you slide back, your skirt will be smoothed for you.

All of these pointers on grace and poise will require much practice for them to become a fixed habit. But it's fun doing it with your girl friends and it's certainly worth all of the time and effort in becoming a graceful girl, admired by all.

Drawstring Apron

Wouldn't you like to make a simple apron that you can wear while making cookies or helping your mother in the kitchen? The drawstring apron shown here is easy and fun to make.

Selecting the fabric

If your mother doesn't have any fabric on hand that you like, you will need to go on a shopping trip. Maybe your club would like to take this shopping trip together. So that you can make the very best choice of fabric—one that

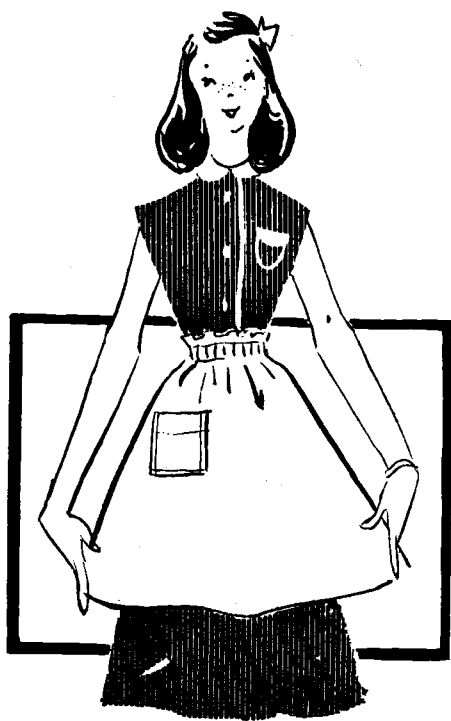

Figure 57.



Figure 58.

you will enjoy—you will need to make some plans.

What color to select?

Answer these questions and it will help you decide. What colors are most becoming to me? What color dresses will I have on while I am wearing the apron? You will want to select a color that blends or contrasts pleasingly with your dresses.

Will it be a print or a solid color?

If most of your dresses are print, then you will want a plain colored apron. Remember the head scarf? You learned then not to use two prints together. A solid color is usually very pleasing with a print. Two solid colors also can be very nice together when there is a soft blending of colors. If you decide upon a print, you will want to be very wise in your choice. The small designs are usually better. Also, a few rather than many colors together are much prettier. 4-H girls in this Clothing Project find simple, dainty, soft designs most becoming.

Will the color fade?

After the material is washed a few times, will it become a dingy, unattractive color? Ask the clerk to let you see the label. However, not all fabrics are labeled. When it is guaranteed not to fade, the label will read



Figure 59.

“Guaranteed fast color to sun and water.” It usually is wiser to buy the fabric with the label guaranteeing the color fastness.

Will the fabric shrink?

Look at the label again. Does it say anything about the material shrinking? If the material is Sanforized or says that it will not shrink over 1 per cent, you need not worry about its shrinking. However, you need not refuse to buy the material just because it is not pre-shrunk. You can shrink it before making the apron. You will learn how to do this at a later club meeting.

Will the fabric wear well?

Is it strong? Is it woven closely? Does it have too much sizing? By that we mean a lot of starch is rolled into the fabric to make it look like strong, firm material. Rub a corner of the material between your finger and thumb. If a white powder comes out, then too much sizing has been added. You will

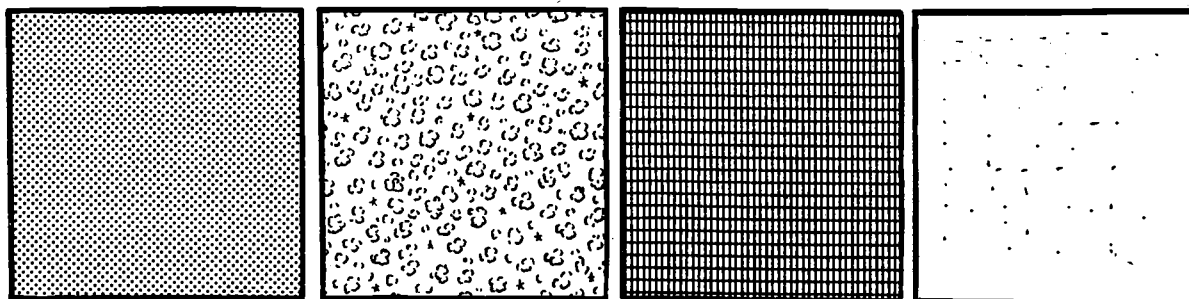

Figure 60.

not want to buy this material. As soon as your apron is washed and the starch or sizing comes out, it will be limp and thin.

What kind of fabric to buy?

It is easiest to work on cotton. The following kinds are suitable for an apron: broadcloth, percale, print, and



Plain percale

Print

Small check
gingham

Broadcloth

Figure 61.

gingham. Organdie or other sheer material is not suitable for a work apron.

How much fabric to buy?



Figure 62.

the hem of your skirt. Add 5 inches for heading and 4 inches for hem.

A girl who finds she measures 19 inches from the waist to the bottom of the skirt hem, will figure as follows:

- 19 inches for apron
- 5 inches for heading
- 4 inches for hem

- 28 inches needed for the apron

For the length—have someone measure from your waistline to the bottom of

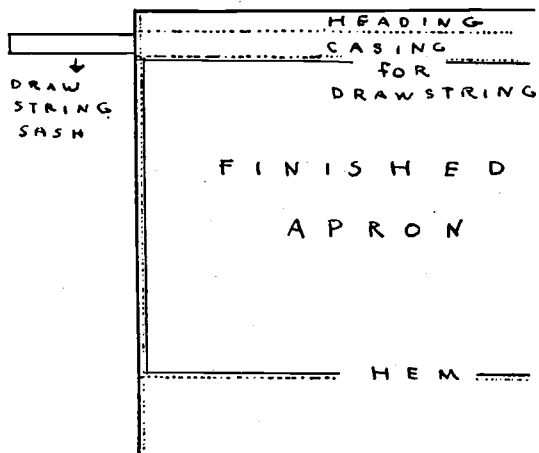

Figure 63.



Figure 64.

If you add 8 inches, you could have two hot pads to match the apron, and then would need to buy one yard of fabric. Figure 65 allows for two hot pads and the apron from one yard.

For an apron of that length, the width should be about 27 inches.

The drawstring should be cut $2\frac{1}{2}$

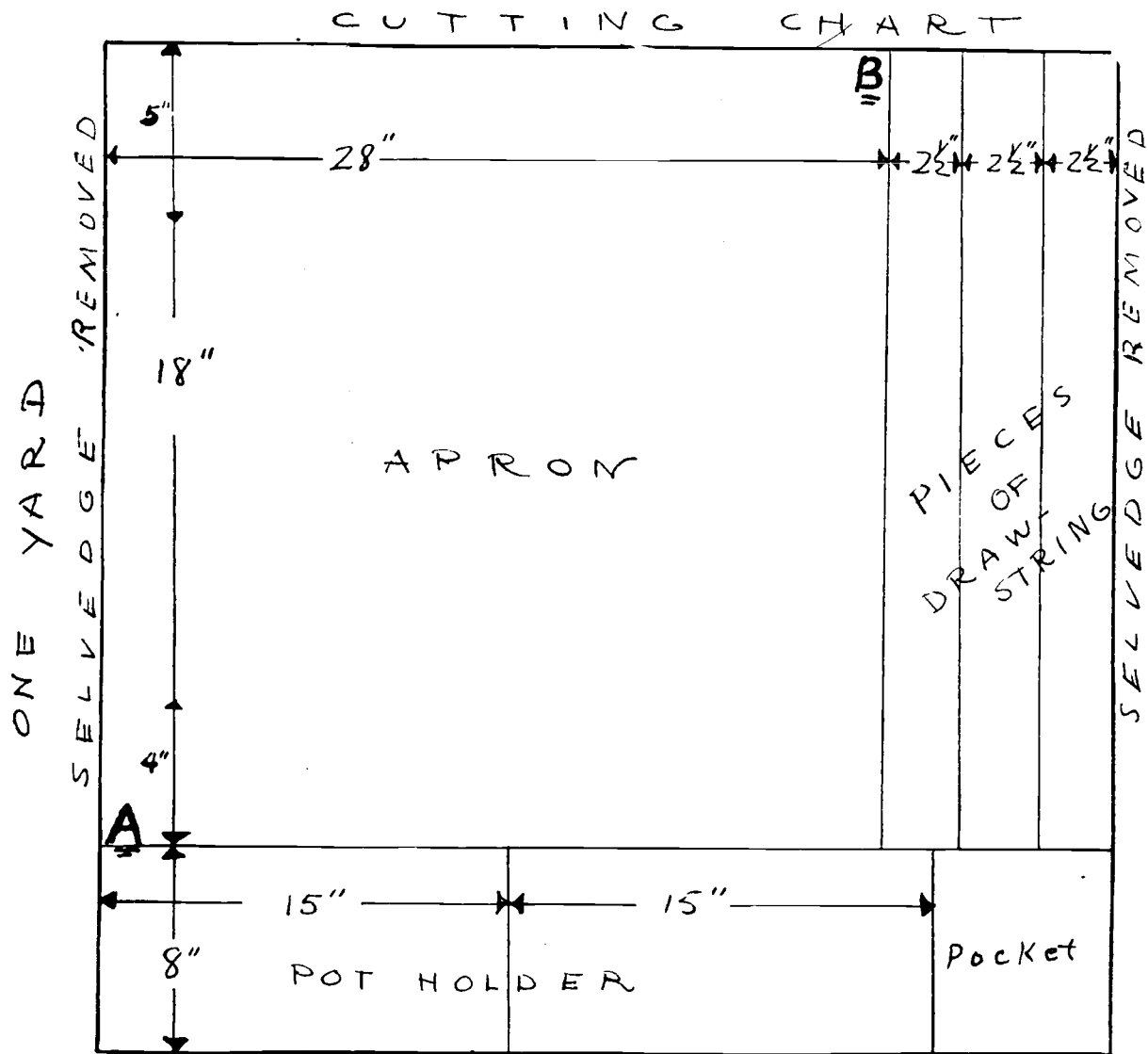

Figure 65.

inches wide and about 70 inches long. A larger girl would need a longer apron and possibly longer drawstrings.

Why not make a drawing like this, using your measurements? Then you can use this as a guide for cutting out the apron.

What other supplies to buy?

If you do not already have suitable thread, you will need a spool of mercerized thread, if the material is colored.

Don't forget—buy a shade darker, for it stitches lighter. A spool of Number 60 thread is the correct size if you are using white thread. So that you will be sure not to forget anything, why not copy these notes in a little notebook and take it with you when you go shopping?

1. Color
(List possible colors you can use.)
2. Print or solid
If a print—small and dainty, not too many colors. Softly blended colors.

3. Is it guaranteed fast color? Label.
4. Will it shrink?—Label. Is it Sanforized?
5. Does it have too much sizing?
6. Kinds of material—broadcloth, percale, print, gingham.
7. Amount of material yards.
8. Thread—Darker mercerized, or 60 white.

Won't it be a thrill to bring home a piece of material that will be suitable and one that you will enjoy wearing?



Shrinking cotton fabric

If your fabric was not preshrunk, you will need to shrink it before starting your apron.

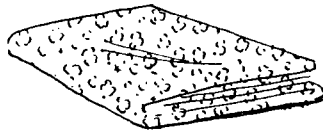
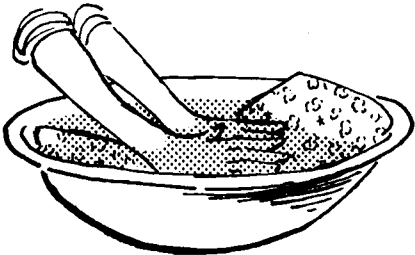
Steps in Shrinking Fabric

<i>Steps</i>	<i>Explanation</i>
1. Straighten fabric, if needed.	If the clerk did not tear your fabric from the bolt, it will need straightening. Do this by pulling a crosswise thread and cutting on this line. Be sure it is straight on both ends.
2. Fold the material back in the folds just as it was when you took it from the package, if you had to unfold it.	 <p data-bbox="1052 1261 1190 1289">Figure 66.</p>
3. Thoroughly wet the material in cold water.	 <p data-bbox="410 1793 548 1821">Figure 67.</p> <ol style="list-style-type: none"> a. Put it in the water folded. b. Be sure that the water penetrates each fold. c. Soak for an hour or more. If it floats, push it down under the water several times during the hour.

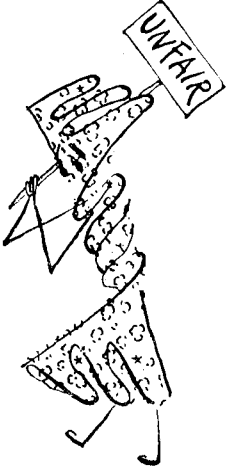
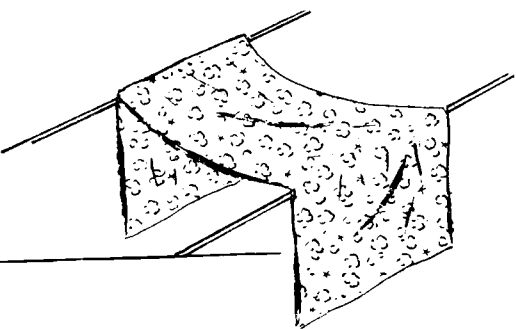
Steps in Shrinking Fabric (*continued*)

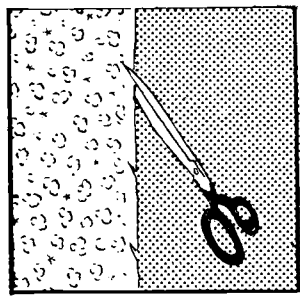
Steps	Explanation
<p>4. Take the material out of the water.</p>  <p>Figure 68.</p>	<p>a. Keep it folded. b. Press out as much water as you can with your hands.</p> <p>WARNING—Do not wring or twist the fabric.</p>  <p>Figure 69.</p>
<p>5. Hang to dry.</p>  <p>Figure 70.</p>  <p>Figure 71.</p>	<p>a. Unfold wet material carefully. b. Loop over two clothes lines. WARNING: Do not use any clothes pins! c. Keep selvedge edges of the length of material together and straighten if needed. d. Hang straight, smoothing the wrinkles out with your hands. If you have handled it very carefully, it probably will not need any pressing. e. If the selvedge seems to be shrinking more than the fabric and puckering it, clip the selvedge every six inches. In a few cases it may be necessary to trim the selvedge off each side because of excess shrinkage.</p>  <p>Figure 72.</p>

Straightening the fabric

After the fabric is shrunk, be very sure that it is straight. You can check by placing the material along the edge of a table. If your cloth looks like this,

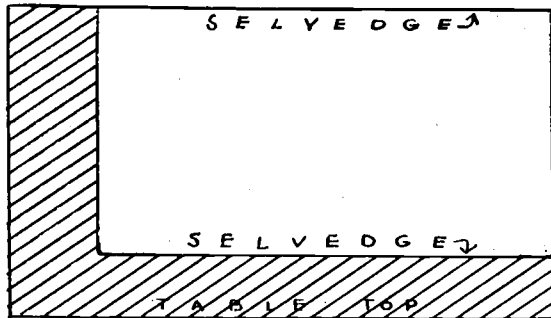

Figure 73.

it is straight. If it looks like Figure 74, it needs to be straightened by pulling the short corner and gradually working toward the true bias line. Pull the rest of the fabric as shown by the arrows.

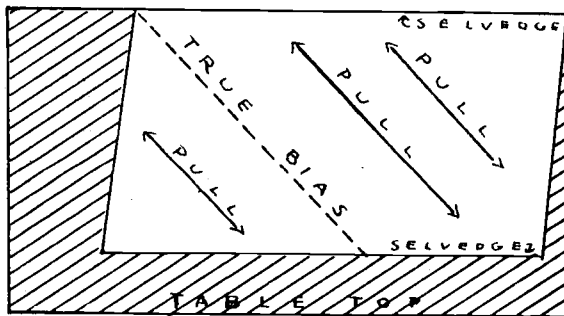

Figure 74.

Making the apron

Cut out the apron

After your material has been shrunk and is absolutely straight of the grain, you are ready to cut out the apron. Here are the steps to follow:

► Trim selvedge off the edge where you are to cut the apron.



Figure 75.

► Draw threads at A and B (refer to Figure 65) and cut a short distance at a time. In that way you can avoid cutting too far in either direction. Use the chart that you made as a guide. In like manner, cut the material for the sash and the pocket. (Refer to Figure 65.)

Stitch the apron

► On the side where you cut the selvedge (which is lengthwise of the material) turn the edge under a scant $\frac{1}{4}$ inch. You are turning the right side over onto the wrong side.

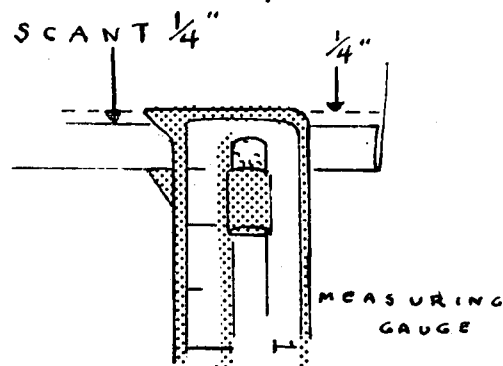

Figure 76.

► Do this same thing on the opposite side.

► Now make another turn over this first one, exactly $\frac{1}{4}$ inch. Baste it down carefully.

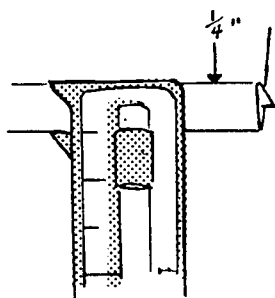

Figure 77.

► Stitch it on the machine. Ask your mother to regulate the stitches so there will be about 14 to 16 stitches to the inch. Stitch near the edge as shown below.

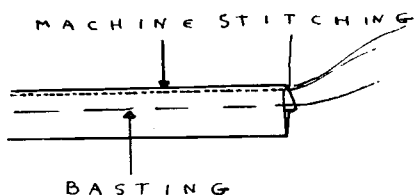

Figure 78.

► Clip threads near the edge. These do not need to be tied since there will be

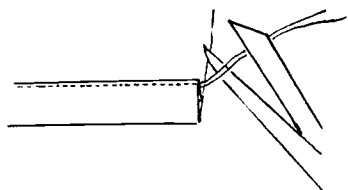

Figure 79.

a row of stitches crossing them. Always keep threads clipped—or tied and clipped—as you work, so that your sewing will not look untidy. Press these

seams. You always press each seam after stitching it before making another row of stitching across it.

Top and casing

► At the top turn under $\frac{1}{4}$ inch just as you did at the sides.

Now turn over $2\frac{1}{2}$ inches. Baste and stitch just as you did the sides. This time you will tie your threads as you learned in making the head scarf.

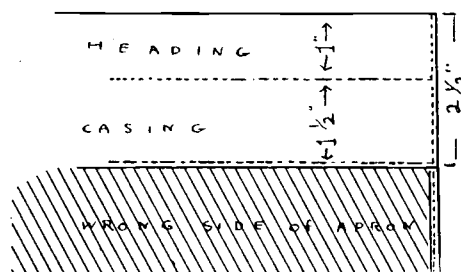

Figure 80.

► Measure 1 inch from the top and make another row of stitching there, again tying threads or back stitching. This forms the case for the drawstring and the heading for the apron.

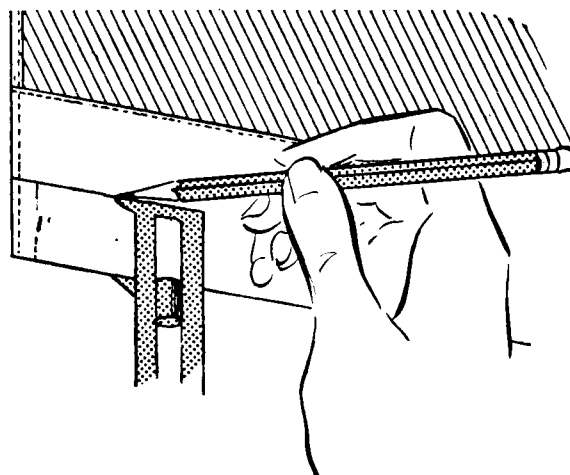

Figure 81.

In order to sew straight, you may measure carefully and draw the line lightly with chalk or a white pencil.

Another method is to use the adhesive tape seam gauge to guide you in sewing straight.

You add the adhesive tape to the machine like this:

► Put the tape measure under the presser foot, placing the needle on the 1-inch mark if you wish to use 1-inch seams. Then place the adhesive tape across the end of the tape measure as shown here. In like manner, for $\frac{1}{2}$ -inch seams, place the needle on the $\frac{1}{2}$ -inch mark on the tape measure and then place the adhesive tape at the end of it.

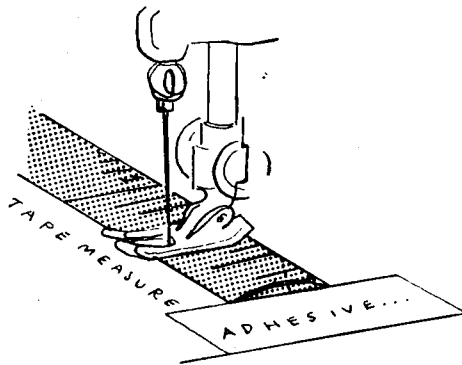

Figure 82.

► The hem comes next. Again turn under about $\frac{1}{4}$ inch. Then turn under 4 inches. Stitch it on the edge as you did for the heading and case for the drawstring.

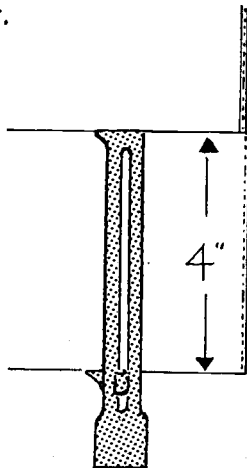

Figure 83.

► To prevent catching the open end of the hem on something and having an accident, whip the edges of the hem together.

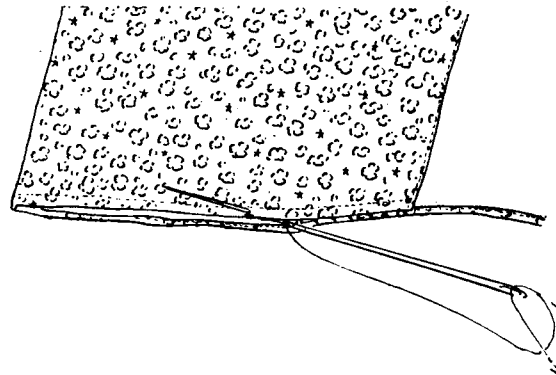

Figure 84.

Pocket

It is nice to have a pocket on the apron. Those of you who are able to do good sewing will enjoy adding a pocket. It is so nice for a handkerchief. The average size pocket is 5 inches by 6 inches before finishing. A few girls may want a larger or smaller one.

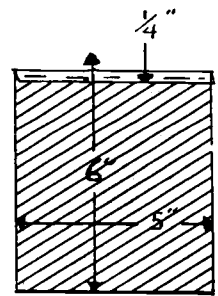

Figure 85.

Make the hem in the pocket first.

► Turn back $\frac{1}{4}$ -inch seam at the top of the pocket and baste.

► Turn a 2-inch hem to the right side and stitch the corners of the hem $\frac{1}{2}$ inch from the edge.

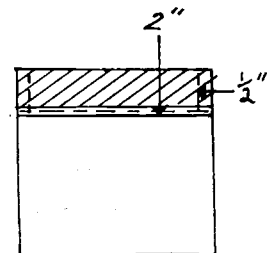

Figure 86.

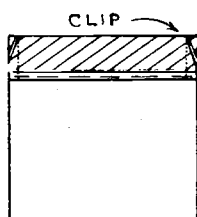

Figure 87.

► Clip the corners, as you did for the corner of the pot holder.

► Turn the hem of the pocket to the wrong side. Baste sides down. Finish the lower corners of pocket just as you did the corners of the pot holder. Press thoroughly. Stitch the hem of the pocket on the machine $\frac{1}{8}$ inch from the folded edge. Tie threads.

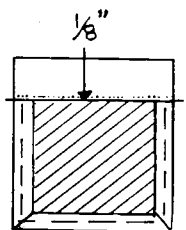

Figure 88.

► Remove bastings across the hem of the pocket.

► Place the pocket on the apron where you think it should be. The usual place is from 4 inches to 6 inches from the waistband and from the sides, depending on the fullness. Pin in place and baste. Then stitch $\frac{1}{8}$ inch or less

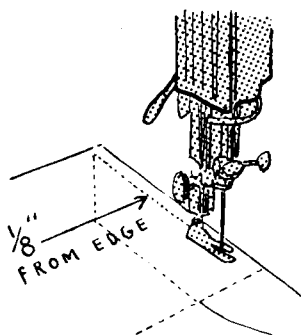

Figure 89.

from the edge as shown. Be sure to make the corner reinforcements. Tie the threads.

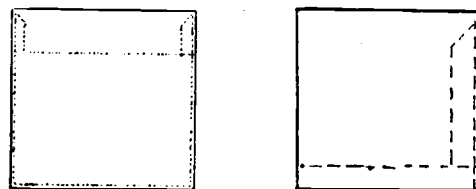

Figure 90.

Drawstring sash

► Join all of the pieces of the sash together with $\frac{1}{4}$ -inch plain seams on the wrong side.



Figure 91.

► Fold the two edges of the sash together the full length and baste. Stitch as shown below, using $\frac{1}{4}$ -inch seams. Adjust your adhesive seam gauge to $\frac{1}{4}$ inch. Leave an opening so the sash can be turned.

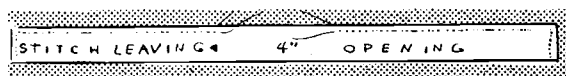

Figure 92.

► Press edges like this.

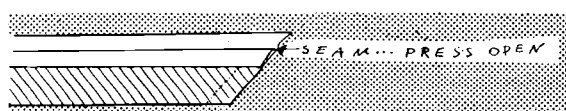

Figure 93.

It makes it easier to straighten the sides when the sash is turned.

► Make three clips at the corners as shown here. You will have nice square corners after the sash is turned.

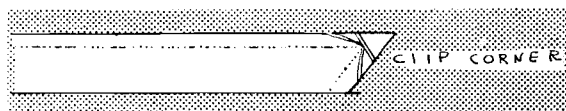

Figure 94.

► Turn sash with a safety pin or a pencil without a point.

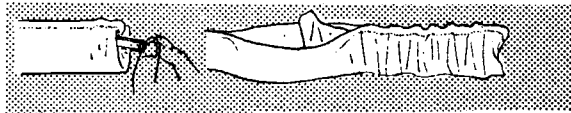

Figure 95.

► Turn edges and carefully lift out the cloth in the corners to form nice corners.

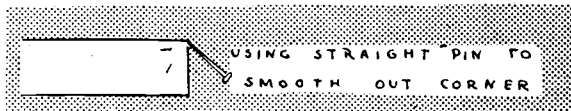

Figure 96.

► Turn the edges of the opening inside. Baste them together. Complete basting around the entire sash. Press well.



Figure 97.

► Stitch around the sash very near the edge as shown.



Figure 98.

Start stitching as shown here. Stitch the two ends and one side. Tie your

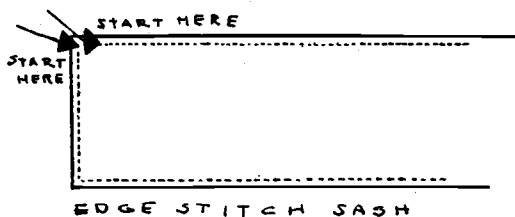

Figure 99.

thread. Start back where you started before and stitch the other side. This keeps the sash from twisting. Stitch over the first stitches for reinforcement. Tie threads.

Press apron

Press the apron very carefully. Learn to press with the grain. It may be necessary to use a damp cloth to press



Figure 100.

it well. However, this will not be so necessary if you have avoided wrinkling your apron and have pressed it carefully after each stitching. You will learn that the iron is almost as valuable a tool as is the sewing machine in producing nice garments. Later you will learn that you can substitute pressing for part of the basting.

Use a safety pin to run the sash, or drawstring, in the apron.

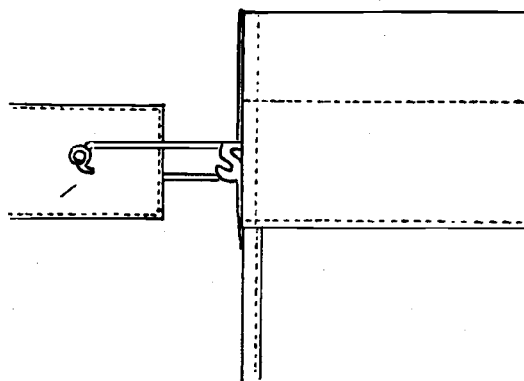

Figure 101.

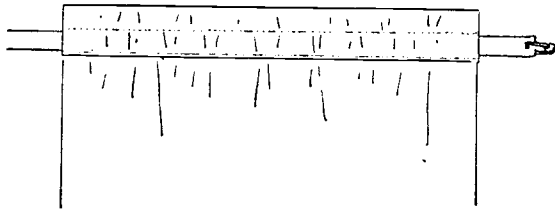

Figure 102.

Wouldn't you like to make an apron for a gift? Even though you did a good job on this one, there are surely ways you can improve on another one.

Remember your motto: "Make the best better!"

Score card for drawstring apron.

1. Was the choice of fabric a wise one?
.....
2. If not, what was wrong?
3. Is it the correct size?
4. Are hems straight and even?
5. Is the stitching even?
- Is the length of the stitches correct for the kind of fabric?
6. Is the pocket in the right place and straight on the apron?
7. Is the open end of the hem whipped neatly together by hand?
8. Is the apron well pressed?
9. Is your apron attractive?

Thinking of Others

Entertain mothers

In 4-H work you have fun doing things for others. Last year you entertained your mothers at a tea and achievement program. This year you will want to do that for your mothers again, but let's do something else, too.

Repair toys

Are there any little boys and girls in your neighborhood who do not have as many toys as do your little brother and sister? It may be that you can collect old toys and repair them and give them to these children. Maybe you can make a rag doll and dress it for a little girl for Christmas.

Make child's book

Another suggestion is to make a child's picture book of cloth and paste colored pictures in it. A tiny child's hands can turn the pages of a cloth

book better than a paper one. If you will start looking in your magazines weeks before you are ready to make the book, you will probably be able to find lovely colored pictures that a child will like. Ask your 4-H leader or Mother to help you make some flour paste for the book. It takes so much paste that it is wise to make your own instead of buying it.

You and your leader will probably think of many other things that you can do. You may be able to make a few pennies to donate to some community activity for helping others.

So let's have fun doing for others!

Acknowledgment:

Artist—Jean Potter.

"Sewing Is Easy and Fun"—by Marjorie Lusk, Extension Specialist in Clothing, The State College of Washington, Pullman, Washington.