

AN ABSTRACT OF THE THESIS OF

Francois J. Bugnon for the degree of Doctor of Philosophy in  
Electrical and Computer Engineering presented on March 21, 1986.

Title: Team Differential Games and Non-Linear Signal Processing

*Redacted for Privacy*

Abstract approved: \_\_\_\_\_

Ronald R. Mohler

Team pursuit-evasion games are studied here with one performance index for the team as a unit in competition with one common opponent. Particular structures of team games are discussed after a brief introduction of the two-player differential games. The classical calculus of variations is used to derive the feedback strategies for team linear, quadratic pursuit-evasion games. Several definitions of the performance index that correspond to different levels of cooperation and hierarchical organization in the team are investigated. The game of kind analysis partitions the players and the space according to their role in the team. Practical solutions to these complex problems rely best on suboptimal schemes. Thus a structural analysis is presented with the intent to simplify the computation of optimal decision and communication processes. Then approximated solutions as well as suboptimal hierarchies for linear quadratic team games are derived. Two-player games provide a great deal of information concerning the solution team games, allowing to compute an approximate solution of a three-player game using a composition method and to derive exactly

the solution of a complex linear quadratic team game from a controllability study by providing terminal-time criteria of selection of unknowns. Hierarchical structures naturally arise; in particular, different filtering structures for a stochastic team game are compared. Detection and localization of the opponent players requires processing from several sources. In the underwater case, direction finding techniques may fail because of the environment (multipath propagation) or, in competitive situations, because of jamming signals. The non-linear processing method developed to alleviate these difficulties also increases the class of problems solved by a given aperture, and is based on the eigenstructure method applied to  $M$ th-order multiplicative signals.

TEAM DIFFERENTIAL GAMES  
AND  
NON-LINEAR SIGNAL PROCESSING

by

Francois J. Bugnon

A THESIS

submitted to

Oregon State University

in partial fulfillment of  
the requirements for the  
degree of

Doctor of Philosophy

Completed March 21, 1986

Commencement June 1986

APPROVED:

*Redacted for Privacy*

\_\_\_\_\_  
Professor of Electrical and Computer Engineering in charge of major

*Redacted for Privacy*

\_\_\_\_\_  
Head of Department of Electrical and Computer Engineering

*Redacted for Privacy*

\_\_\_\_\_  
Dean of Graduate School

Date thesis is presented March 21, 1986

Typed by Lyndalu Sikes for Francois J. Bugnon

#### ACKNOWLEDGEMENT

I would like to thank the members of my committee for their availability and, in particular, Professor R. R. Mohler for a never-dieing interest and support in both curriculum as well as extra-curriculum activities.

Inspiring, state of the art quotes concerning the game theory are many, but my preferred ones are from Shakespeare, claiming that

In playing, there are two pleasures for your choosing,  
The one is winning, and the other loosing,

and Baudelaire, who wrote about

Ce fol amour du jeu, qui hante les tricheurs. . .

## TABLE OF CONTENTS

I.	INTRODUCTION	1
II.	TWO-PLAYER DIFFERENTIAL GAMES	5
	1. Introduction	5
	2. Discrete games	6
	3. A Pursuit-evasion Differential Game: the Homicidal Chauffeur Game	9
III.	INTRODUCTION TO TEAM DIFFERENTIAL GAMES	29
	1. Introduction	29
	2. Factors to Consider to State a Team Game	30
	3. Necessary Conditions of Optimality for Generalized Team Games	34
IV.	THE GAME OF KIND	46
	1. Introduction	46
	2. Pursuer Classes	47
	3. Two-versus-one Pursuit-evasion Zones	48
	4. The Help Zone	52
	5. Approximations of the No-help Zone	53
	6. Two-cutters vs. Railroad Example	55
V.	THE LINEAR QUADRATIC GAME OF DEGREE	61
	1. The Quadratic Team Games	61
	2. 1-vs.-1 Linear Quadratic Game of Degree	62
	3. Two-vs.-one game solution	64
	4. Structure of an N-identical-pursuer, One-evader Linear Quadratic Game	66
	5. A Sub-optimal Structure	69
VI.	A COMPOSITION APPROXIMATING ALGORITHM	72
	1. Introduction	72
	2. Analytic Composition	73
	3. An Approximation Procedure	77
	4. Time Optimal Example	83
VII.	A CONTROLLABILITY STUDY FOR LINEAR QUADRATIC TEAM GAMES	92
	1. Introduction	92
	2. Formulation of the Game	92
	3. Controllability Study of the Team Differential Game	97
	4. Most Controllable Disposition of Pursuit Team	100
	5. Example	102

TABLE OF CONTENTS (Continued)

VIII.	STRUCTURAL CHOICES OF A STOCHASTIC DIFFERENTIAL TEAM GAME	104
	1. Introduction	104
	2. Game Statement	105
	3. Communication Structure	108
	4. The Two Structures	111
	5. Comparing $I(K_1, T_1)$ with $J(K_1, T_1)$	122
	6. Comparing $J(K_2, T_2)$ with $I(K_2, T_2)$	126
	7. A Modified Scalar Case	127
	8. Conclusion	134
IX.	A NON-LINEAR APPROACH TO THE DIRECTION-FINDING PROBLEM	136
	1. Introduction	136
	2. Problem Statement	138
	3. The Eigenstructure Generating Function	141
	4. Minimum Sensor Configurations	146
	5. Conclusion	149
X.	CONCLUSIONS	151
XI.	BIBLIOGRAPHY	154

LIST OF FIGURES

<u>Figure</u>	<u>Page</u>
1. Relative coordinates.	11
2. Homicidal chauffeur game with infinite capture zone.	17
3. Homicidal chauffeur game with restricted capture zone.	17
4. Reversed homicidal chauffeur game.	19
5. Bilinear approximation of the homicidal chauffeur game.	20
6. Vectogram approximations.	22
7. Square vectogram approximation of the homicidal chauffeur game.	22
8. The direct pursuit case.	25
9. The wall pursuit game.	25
10. The collision dilemma.	26
11. Three particular asymmetrical games.	28
12. Terminal time differentials.	37
13. Cooperative zones for 2-vs.-1 example with pursuer speed $p_2 = 1.5$ .	59
14. Cooperative zones for 2-vs.-1 example with pursuer speed $p_2 = 0.5$ .	60
15. Nesting hierarchical structure for N-vs.-1 linear quadratic game.	68
16. Sub-optimal simple field hierarchical structure for the N-vs.-1 linear quadratic game.	70
17. Independent hierarchical structure for the N-vs.-1 linear quadratic game.	71
18. Composition approximating algorithm for 2-vs.-1 game.	77
19. Time-optimal solution sensitivity for cooperation by $z_2$ .	85



LIST OF FIGURES (Continued)

<u>Figure</u>		<u>Page</u>
20.	Sensitivity relative to second pursuer close to 1-vs.-1 game.	86
21.	Time-optimal solution for 1-vs.-1 game.	87
22.	Time-optimal solution for 1-vs.-1 Pareto game.	88
23.	Time-optimal control approximations for Table 3.	90
24.	Computation of cooperation-time limit.	90
25.	Most controllable two-pursuer team.	103
26.	Block-diagram of the centralized game structure.	112
27.	Block-diagram of the decentralized structure.	116
28.	Optimal trajectories for case 1.	132
29.	Optimal trajectories for case 2.	132
30.	Minimum sensor configuration for n coherent sources.	149

LIST OF TABLES

<u>Table</u>		<u>Page</u>
1.	Matrix game with a pure strategy.	7
2.	Matrix game with a mixed strategy.	8
3.	Time-optimal approximate solution comparisons for three different degrees of cooperation.	91
4.	Payoff matrix.	120
5.	Performances for non-perfect information game.	133

## TEAM DIFFERENTIAL GAMES AND NON-LINEAR SIGNAL PROCESSING

### I. INTRODUCTION

Many control problems involve the modelling of some unknown, possibly deterministic, processes, as the signal processing of measurements from a target, performed by one or more channels. In the absence of knowledge of the target motion, most models assume either a stochastic type of dynamics or a given simple motion, such as a constant course. Then various techniques are used to recover from unexpected target maneuvers, including input estimation, variable dimension filtering approaches, white noise models with adjustable level or with several levels (Reference [1] provides further bibliography). The signal processing task could be made easier if some knowledge of the behavior of targets were known. But, usually, in a hostile environment, the target expects to be tracked or chased, thus, a competitive situation arises between the various observing channels processing the data and the unwilling target, requiring the study of a team pursuit-evasion game problem.

Formerly introduced by the pioneering work of Von Neuman and Morgenstern [2] the discrete game analysis embodied most of the principles of the game theory yet recognized as important. But it is not until the concurrent development of the optimal control theory and the introduction of the differential games by Isaacs [3] that the game theory came of age.

After a ten year initial surge triggered by the publication of Isaacs' work, the study of the games was mainly captured by mathematicians rather than engineers. A more mathematical approach of the games emerges; the early results were given a more solid theoretical support and were extended, as in Friedman [4]. In particular, bargaining games, in which  $N$  players individually attempt to achieve some optimal performance by contracting alliances, were advanced to a better understanding. Nevertheless, the last few years experienced a renewed interest from the engineering community for differential games, a typical problem being the stochastic missile versus airplane control problem viewed as a game (Jarmark [5], Shinar [6]). Together with the progresses made in multi-target tracking (Bar-Shalom [7]), the 1-vs.- $N$  game where a single missile faces several possible targets was also considered (Breakwell [8]).

This brief history of the games is herein schematically partitioned into four different "eras"; though questionable, this classification has the merit of enhancing the various  $N$ -player games considered. First came, as a generalization, the games in which the  $N$  players compete individually, then a few particular games were solved relying on geometrical or intuitive remarks, as in the game where two cutters attempt to prevent the escape of an evader (Isaacs [3]). Then came the bargaining games and coalition formation problems, both with a clear economical or political ulterior motive, and last came the one versus many games where a single pursuer must choose between several possible evaders as a first target.

Team differential pursuit-evasion games studied here involve coplayers who strive against a common opponent, such as an athletic

team with a common goal. The individual performance is superseded by that of the team as a whole. Clearly, this is not a typical N-player game of the more common variety. Nor can it be treated as a second phase of a bargaining game with coalitions already formed, such as studied by Von Neuman and Morgenstern [2], since the principle of optimality does not apply to the individual players but only to the team as a unit.

In the literature, team decision theory refers to the games where a group of agents, acquiring different information, work together in a coordinated effort to achieve a common goal, as in Bagchi and Basar [9], but the competitive aspect is missing in these games.

Hereafter, the common opponent game is referred to as the team game or the N-versus-one game. The players of the game are called "pursuers" and the common opponent, "evader", in keeping with the spirit of "sink the Bismark".

Solving even the simplest team game is a very difficult task, and to cope with the curse of dimensionality, analysis of the simpler 1-vs.-1 game will be taken advantage of. Long before the battle of Salamis (480 BC), the need for a strict organization in obtaining optimal results from individual elements was recognized. Therefore, hierarchical structures are introduced and sometimes simplified, as early as possible; decentralized and suboptimal structures are looked for because they usually yield tractable solutions or more robust schemes.

In Chapter II, matrix games and the well known homicidal chauffeur game are used as a guideline to present a few concepts about

differential games whose understanding is required. Chapter III discusses various pitfalls and underlying assumptions in the formulation of a team game; the calculus of variations is applied to yield the necessary conditions of optimality for team games. The game of kind, partitioning the pursuers and early structural game solutions is the object of Chapter IV. The next chapter focuses on the linear quadratic team differential games, expressing the solution in a compact form and deriving  $C^3$  (command, control, communication) suboptimal structures. A composition approximation to reduce the computations required for linear quadratic team games is presented in Chapter VI. Chapter VII studies a fixed terminal time quadratic game from a controllability point of view to provide criteria to select the terminal time unknowns, and shows how it yields the solution to a complex problem of optimal location of a pursuer in a team. Stochastic team games are envisioned in Chapter VIII, for which hierarchical options prove fundamental. The next chapter features a non-linear signal processing technique to detect and locate the various players in an unfriendly environment, where multipath propagation and jamming either force the classical, linear methods to fail or, at best, to considerably reduce the effective array aperture.

## II. TWO-PLAYER DIFFERENTIAL GAMES

### 1. INTRODUCTION

Let  $S$  be a system including two variables  $u$  and  $v$  controlled by two distinct parties  $P_1$  and  $P_2$  who strive to maximize two corresponding performance indices  $J_1$  and  $J_2$ . Then, a game situation arises whenever the control policies of either player at the present time is not known by both parties, hereafter named "players".

When each player has all information about the system to control, the form of the performance indices and the other player's choice of strategies, the game is a perfect information game.

Particular games for which only one player is aware of the other player's strategy are called hierarchical or Stackelberg games. One player, the leader, announces his strategy first and the other player, the follower, reacts accordingly. When both maximizing players have identical performance indices and goals, a Pareto game is defined. Otherwise, whenever  $J_1$  and  $J_2$  differ, conflicting interests create a competitive situation. The game is a zero-sum game if  $J_1 + J_2 = 0$ , that is, when the interests of the players are opposite; otherwise, a non-zero-sum game is defined. Competitive games are usually defined in terms of a maximizing and a minimizing player.

When the number of strategies available is countable, the game is said to be discrete. If there is a finite number of possible strategies, a payoff can immediately be associated with each playable control pair  $(u, v)$  and the game can be put under a convenient matrix

form. On the other hand, an uncountable number of possible strategies characterizes continuous games. A differential game is a continuous game for which the system on which the controls apply is defined in terms of a set of lumped differential equations. Classical examples are Lanchester's equations and the predator-prey equations.

The study of gambling gave game theory its name, but the most obvious application of game theory is to clear competitive situations such as pursuit-evasion games, combat models and macro-economic behavior and strategies. Yet, a very important domain of application of game theory is in optimization problems with unpredictable parameters or forcing functions. The classical method solves that problem as a stochastic control problem, modelling the unknown as a random parameter, provided that the statistics of the unknown be a priori specified. Otherwise, a worst case study might be necessary. This conservative approach assumes that the unknown parameter or forcing function is controlled by an intelligent adversary, in a zero-sum game formulation. The method can be used to replace a stochastic problem by a deterministic one. Problems such as ship collision avoidance or games against nature are treated this way.

A few of the important concepts concerning two-player game theory are introduced below, rather informally, in order to provide a basis to the study of team games. A more complete study of discrete games can be found in [2]; [3] introduces differential games, and pursuit-evasion games are focused upon in [10].

## 2. DISCRETE GAMES

In the following perfect information, zero-sum competitive



discrete game, the maximizing player P1 has two available strategies:  $u_1$  and  $u_2$  that select a row in the matrix, when P2, the minimizing player, can choose either column 1 or 2.

Table 1. Matrix game with a pure strategy.

---

		Player P1	
		$v_1$	$v_2$
Player P2	$u_1$	2	3
	$u_2$	1	4

---

The payoff corresponding to the play  $(u_i, v_j)$  is the matrix coefficient  $L_{ij}$ . Since both players must announce their strategy at the same time, it seems natural for P1 to choose the row with the smallest maximum and for P2 to choose the column with the largest minimum. Then:

$$\max_i \min_j L_{ij} = 3, \text{ P1 plays first}$$

and

$$\min_j \max_i L_{ij} = 3, \text{ P2 plays first.}$$

When both expected payoffs match, the result is called "value of the game". The strategy  $(u^* = u_1, v^* = v_2)$  is an equilibrium solution, named "minimax strategy".

The main problem with the minimax strategy is that it requires an exhaustive search over all the possible strategies. Clearly, this is unsuitable to large dimensioned matrices or to continuous

games. A quicker converging strategy is the Nash equilibrium strategy. It is defined as:

$$u^* = \arg(\max_{u_i} L(u_i, v^*)) ,$$

$$v^* = \arg(\min_{v_j} L(u^*, v_j)) .$$

The two above equations must hold simultaneously, and the search is made for a fixed assumed optimal strategy for the other player. It can immediately be understood that a Nash strategy corresponds to a local equilibrium concept, when the minimax strategy corresponds to a global equilibrium. Consequently, uniqueness is not ensured, as the following example shows, in which both minimizing players P1 and P2 face two possible Nash equilibria, namely  $(u_1, v_1)$  and  $(u_2, v_2)$ , and a minimax  $(u_2, v_1)$ .

Table 2. Matrix game with a mixed strategy.

---

		Player P1	
		$v_1$	$v_2$
Player P2	$u_1$	0	2
	$u_2$	1	0

---

Moreover, games for which no unique choice, named pure strategy, can satisfy  $\min \max L_{ij} = \max \min L_{ij}$ , do not have a Nash strategy in pure strategies. Then, as the game repeats itself, the controls must be chosen in a probabilistic way, defining a "mixed strategy". The corresponding averaged payoff then satisfies  $\min \max L_{ij} = \max \min L_{ij}$ .

A well known theorem states that the value of a game always exists in pure or mixed strategies for matrix games.

Though simpler in their definition, discrete games show many of the important characteristics of continuous games, such as the information structure, the various equilibrium strategies, the definition of a unique quantity called the value of the game, and the possible occurrence of a mixed strategy.

### 3. A PURSUIT-EVASION DIFFERENTIAL GAME: THE HOMICIDAL CHAUFFEUR GAME

#### 3.1 Presentation of the game

A general form for the performance index of a zero-sum game is

$$J(u,v) = g(x(t_f), t_f) + \int_{t_0}^{t_f} h(x, u, v, t) dt . \quad (1)$$

If  $g(x(t_f), t_f) = 0$  and  $\max_v \min_u h(x, u, v, t) \geq 0$ , the game is said to be a generalized pursuit-evasion game.

It is assumed that the differential equations describing the motion or policy of the various players as well as the initial positions, are given. Then, as the game proceeds, the evader attempts to avoid the various capture zones related to the pursuers. The classical method divides the game initially at  $t = t_0$ , into two distinct phases, named the game of kind and the game of degree.

The game of kind can be summarized as finding the answer to the question: is capture possible? Once capture is assumed to be possible, the game of degree attempts to find the optimal way to conclude the game. Three approaches are used here to solve the game of degree;

i.e. classical optimal control theory, heuristic approaches relying on simple geometrical considerations and approximation methods tailored to specific games.

To illustrate further definitions and remarks, a specific example is treated. The homicidal chauffeur game, also known as "the two-car problem", is one of the best examples of pursuit-evasion games. Both its simplicity and its versatility are remarkable. The derivation of the classical one-pursuer-one-evader solution borrows heavily from Isaacs [3].

A pursuer P, of speed  $p$  and control  $u$ , attempts to capture, in minimum time, an evader E of speed  $e$  and control  $v$ . The heading angle rates are subject to the controls. The dynamics obey the following lumped differential equations

$$\begin{aligned}\dot{x}_{1p} &= p \sin(\theta_p) , \\ \dot{x}_{2p} &= p \cos(\theta_p) , \\ \dot{\theta}_p &= u ,\end{aligned}\tag{2}$$

for the pursuer, and the dynamics of the evader are

$$\begin{aligned}\dot{x}_{1e} &= e \sin(\theta_e) , \\ \dot{x}_{2e} &= e \cos(\theta_e) , \\ \dot{\theta}_e &= v .\end{aligned}\tag{3}$$

In an unconstrained space, only the relative position of the two players matter. The classical approach reduces the game by fixing P at the origin, defining the new coordinates, according to Figure 1, as

$$x_1 = (x_{1e} - x_{1p})\sin(\theta_p) - (x_{2e} - x_{2p})\cos(\theta_p) , \quad (4)$$

$$x_2 = (x_{1e} - x_{1p})\cos(\theta_p) + (x_{2e} - x_{2p})\sin(\theta_p) .$$

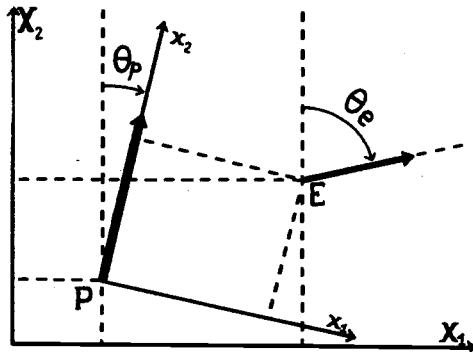

Figure 1. Relative coordinates.

The reduced state differential equations take the form

$$\begin{aligned} \dot{x}_1 &= -ux_2 + e\sin(\theta_e - \theta_p) , \\ \dot{x}_2 &= ux_1 + e\cos(\theta_e - \theta_p) - p , \\ (\dot{\theta}_e - \dot{\theta}_p) &= v - u . \end{aligned} \quad (5)$$

The control of the pursuer,  $u$ , is constrained by  $|u| \leq U$ , defining a sharpest turn rate of  $U$  rd/sec. The evader is assumed to have complete control of its angle rate  $v$ . Therefore,  $E$  controls the angle  $\theta_e - \theta_p$  completely. That angle is now defined as the new variable, hereby reducing the state equations to

$$\dot{x}_1 = -ux_2 + e\sin(v) , \quad (6)$$

$$\dot{x}_2 = ux_1 + e\cos(v) - p .$$

In general,  $p > e$  is enforced, thus the pursuit-evasion game represents a study of the speed versus maneuverability type.

Capture is achieved whenever E is forced within the terminal manifold, or lethal area, of P, described by a matrix M and a scalar r as

$$\mathbf{x}^T M \mathbf{x} \leq r^2 . \quad (7)$$

In the sequel,  $M = I$ , and the lethal area is a circle of radius r; the terminal manifold is described by

$$x_1^2 + x_2^2 - r^2 \leq 0 . \quad (8)$$

### 3.2 Solution of the game by the calculus of variations

The performance index

$$J(u, v) = \int_{t_0}^{t_f} dt = t_f - t_0 , \quad (9)$$

is associated with the state (6) in the Hamiltonian

$$H(u, v) = 1 + \lambda_1(-ux_2 + e\sin(v)) + \lambda_2(ux_1 + e\cos(v) - p) , \quad (10)$$

by adjoining the costate vector  $\lambda = (\lambda_1, \lambda_2)$ . The costate variables propagate according to

$$\begin{aligned} \dot{\lambda}_1 &= \frac{-\partial H}{\partial x_1} = -\lambda_2 u , \\ \dot{\lambda}_2 &= \frac{-\partial H}{\partial x_2} = \lambda_1 u , \end{aligned} \quad (11)$$

and the transversality condition provides a terminal time relationship as

$$\begin{aligned}\lambda_1(t_f) &= v \frac{\partial(x_1^2 + x_2^2 - r^2)}{\partial x_1} = vx_1(t_f) , \\ \lambda_2(t_f) &= v \frac{\partial(x_1^2 + x_2^2 - r^2)}{\partial x_2} = vx_2(t_f) ,\end{aligned}\tag{12}$$

expressing the orthogonality of the costate vector with the terminal manifold at the terminal time;  $v$  is a Lagrange multiplier whose value must be such that

$$H(t_f) = 0\tag{13}$$

holds.

The optimal controls corresponding to a Nash equilibrium strategy, or defining a game theoretic saddle-point, are computed by applying the minimum (and maximum) principle as

$$\begin{aligned}u^* &= \arg(\min_{|u| \leq U} H(u, v^*)) , \\ v^* &= \arg(\max_v H(u^*, v)) .\end{aligned}\tag{14}$$

Generally, a game theoretic saddle-point does not exist unless the Hamiltonian is separable, that is, unless Isaacs' condition

$$H(u, v) = H_u(u) + H_v(v) ,\tag{15}$$

is satisfied.

The knowledge of the initial state together with (12) allows classification of the one-pursuer-one-evader homicidal chauffeur game as a classical two-point boundary-value problem.

Developing the above equations, introducing a reverse time  $\tau = t_f - t$  and a terminal hit angle  $\alpha$ , the optimal policies can be derived as

$$\begin{aligned} u^* &= U \text{sign}(x_2 \sin(UT+\alpha) - x_1 \cos(UT+\alpha)) , \\ v^* &= UT+\alpha , \end{aligned} \tag{16}$$

where sign is the signum function.

The retrograde path equations, integrated from a terminal hit point in the reduced coordinate system are

$$\begin{aligned} x_1(\tau) &= p - p \cos(UT) + e(r-\tau) \sin(UT+\alpha) , \\ x_2(\tau) &= p \sin(UT) + e(r-\tau) \cos(UT+\alpha) . \end{aligned} \tag{17}$$

Equations (17) are valid up to the first switch in  $u$ , then, according to the new value of  $u$ , a new set of differential equations are to be integrated until the next switch. A trial and error procedure must be used to find the proper hit angle that corresponds to the initial condition  $(x_1(t_0), x_2(t_0))$ .

Due to the particular example, the exact value of the Lagrange multiplier  $v$  is irrelevant. In most games, finding a suitable value of  $v$  that satisfies (13) is an acute problem since the multiplication of the costate vector by the controls yields, even in the simplest case, a second-order equation in  $v$ , often including non-linear elements such as absolute values, which may produce zero, one or two possible solutions. Though a global study, even for the simplest linear game is nearly impossible, only one value of  $v$  at a time seems



to be the rule since possible values of  $v$  are checked against two important conditions: the playability and capturability conditions.

The playability condition states that, if pursuer  $P$  captures  $E$  at  $t = t_f$ , and if  $g(x(t_f)) \leq 0$  describes the terminal manifold, then the scalar product

$$\vec{\text{grad}}(g(x(t_f))) \cdot \dot{\vec{x}}(t_f) \leq 0 \quad (18)$$

is negative. The playability condition expresses the simple fact that, in order for capture to be performed, the evader must penetrate into the terminal manifold. When the terminal manifold is a circle,  $x(t_f)$  is a normal vector to the terminal manifold, parallel to the costate vector since the transversality condition holds. Then, an equivalent form is

$$\lambda(t_f) \cdot \dot{\vec{x}}(t_f) \leq 0 \quad (19)$$

The capturability condition is defined as

$$H(t_f) - k \leq 0 \quad (20)$$

with  $k$ , a positive constant. Compared with (13), the capturability condition appears trivial. For minimum-time problems, it is convenient to choose  $k = 1$ . Then, (20) and (19) are equivalent conditions for one-pursuer-one-evader games.

Nevertheless, the capturability is a global condition on the game, when the playability condition must be respected by every single pursuer actively participating in the capture, thus, for team games, these two conditions are clearly different. The distinction between capturability and playability has been overlooked so far in the study of the one-versus-one games.

For the two-car problem, the condition expressed by (19) gives  $e \leq p$ , the obvious requirement that the pursuer be faster than the evader.

When the capture area is defined by a time-invariant equation, it is convenient to apply the playability condition to the terminal manifold. In some instances, it defines the portion of the terminal manifold that can be used in order to capture the evader, named "the usable part of the terminal manifold". The usable part is not a characteristic of the game studied but depends rather on the way the game is studied. For the homicidal chauffeur game, the usable part can easily be computed as the part of the circle for which

$$x_2(t_f) \geq re/p . \quad (21)$$

The optimal trajectories conducted from the two points  $x_2(t_f) = re/p$  are referred to as "semi-permeable lines". These lines separate capture from escape and are best characterized by the fact that the payoff is discontinuous across them. Permeability ensures that only under a non-optimal play can the trajectory cross that border line. If the semi-permeable lines intersect, the capture zone is finite. Solving  $\dot{x}_1 = 0$  with (21) and (17) gives the condition  $r \leq r_0$  under which the semi-permeable lines intersect.

Figures 2 and 3 show two possible sets of trajectories. In the more interesting case of Figure 2, singular behaviors are numerous. The semi-permeable lines stop at point C and C', consequently, if the evader is located around point E, a swerve motion is adopted by P, turning left, away from the evader at first, in order to go around C,

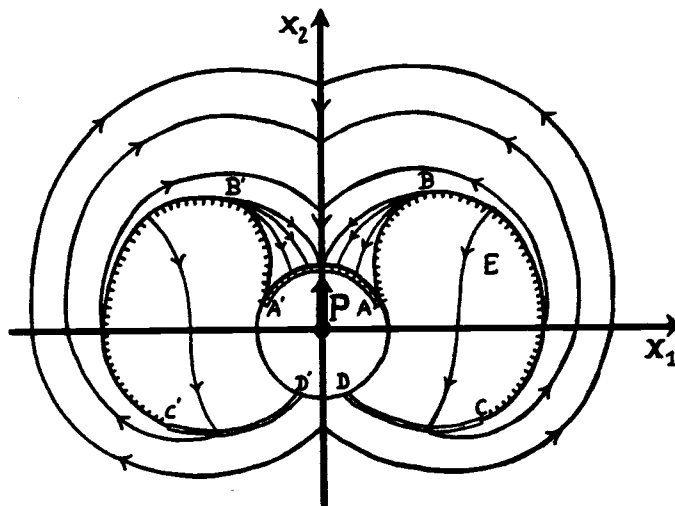





-  Switching line in  $u$ .
-  Usable part of the terminal manifold.
-  Semi-permeable line.
-  Trajectory.

Figure 2. Homicidal chauffeur game with infinite capture zone.



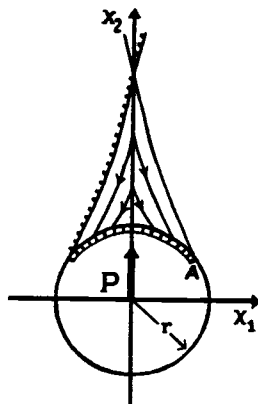

-  Usable part of the terminal manifold.
-  Semi-permeable line.
-  Trajectory.

Figure 3. Homicidal chauffeur game with restricted capture zone.

and then right to face the evader and achieve capture in a linear course. At points B and B', an infinite number of optimal strategies are available. Along the lower half of axis  $x_2$ , the optimal value for  $u$  is  $U$  or  $-U$ , whereas the upper half corresponds to a more classical singular solution  $u^* = 0$ . Thus, the study of the singularities nearly represents the whole effort in solving the two-car problem.

### 3.3 Further studies of the homicidal chauffeur game

Unlike the choice made so far, an obvious reduction choice to study the N-versus-one homicidal chauffeur game is to position the evader at the origin. If all the capture sets are circles of identical radius, an equivalent "safety set" surrounding the evader can be defined. Then, the state equations are

$$\begin{aligned}\dot{x}_1 &= x_2 v + p \sin(u) , \\ \dot{x}_2 &= -x_1 v + p \cos(u) - e .\end{aligned}\tag{22}$$

When  $p > e$ , the usable part of the terminal manifold is not restricted, and consequently, the part of the study involving singular behavior such as the semi-permeable lines cannot be conducted. Trajectories, from a hit angle  $\alpha$ , are integrated as

$$\begin{aligned}x_1 &= -e + e \cos(V\tau) + p(r+\tau) \sin(-V\tau + \alpha) , \\ x_2 &= -e \sin(V\tau) + p(r+\tau) \cos(-V\tau + \alpha) ,\end{aligned}\tag{23}$$

and are plotted in Figure 4.

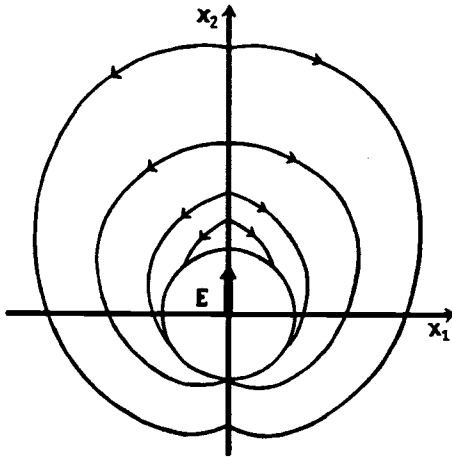

Figure 4. Reversed homicidal chauffeur game.

Trigonometric functions as in (6) are quite cumbersome to deal with, a linear or bilinear set of differential equations to approximate the exact game would simplify the study of the team game. The homicidal chauffeur game is equivalent to an extended-state bilinear model if the control  $v$  is constrained as

$$|v| \leq V = 0.3 . \quad (24)$$

Then, the state equations for that game are

$$\dot{\mathbf{x}} = \mathbf{A}\mathbf{x} + \mathbf{B}\mathbf{u} + \mathbf{C}\mathbf{v} , \quad (25)$$

$$\mathbf{A} = \begin{bmatrix} 0 & 0 & 0 \\ 0 & 0 & e-p \\ 0 & 0 & 0 \end{bmatrix} , \quad \mathbf{B} = \begin{bmatrix} 0 & 1 & 0 \\ 1 & 0 & 0 \\ 0 & 0 & 0 \end{bmatrix} , \quad \mathbf{C} = \begin{bmatrix} e \\ 0 \\ 0 \end{bmatrix} .$$

A deviation of the solution can be conducted in a similar fashion as previously. The trajectories, shown in Figure 5, are sections of circles whose centers and radii change at every switchings of the control variables  $u$  and  $v$ .

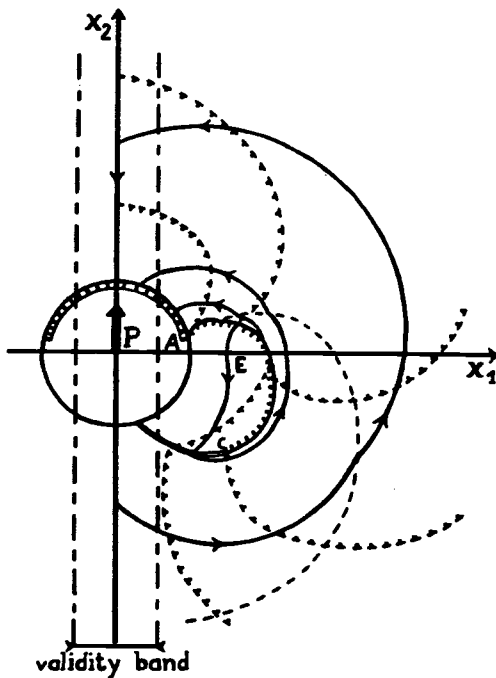

- ▬▬▬ Usable part.
- ⋯⋯⋯ Constant terminal time.
- Optimal trajectory.
- ⋯⋯⋯ Semi-permeable line.
- ▬▬▬ Switching line of  $u$ .
- ⋯⋯⋯ Switching line of  $v$ .

Figure 5. Bilinear approximation of the homicidal chauffeur game.

The non-reduced trajectories would show that the evader adopts a nearly parallel course to the pursuer, because of the constraint on  $v$ . Nevertheless, it is remarkable that the same type of trajectories and policies are found for the bilinear approximation of the homicidal chauffeur game even outside the area defined by  $|v| \leq 0.3$ , in which the approximation is valid. On the other hand, the validity band only includes the terminal end game maneuvers, thereby excluding the interesting phases of the pursuit.

Actually, the vectogram corresponding to the original homicidal chauffeur game is given by the vector  $(\sin(v), \cos(v))$ , when for the bilinear approximation, it is given by the vector  $(1, v)$  for  $|v| \leq 0.3$ . As Figure 6 shows, it is a rather poor approximation. A better approximation is the square vectogram approximation. To give a more convenient set of state equations, the circle is approximated as closely as possible with the simplest form possible. The new equations are

$$\begin{aligned}\dot{x}_1 &= -ux_2 + av_1, \\ \dot{x}_2 &= ux_1 + av_2 - p,\end{aligned}\tag{26}$$

where the controls are constrained as

$$\begin{aligned}|u| &\leq U, \\ |v_1| + |v_2| &\leq a.\end{aligned}\tag{27}$$

Actually, only the four vectors corresponding to the corners of the square ( $v_1 \cdot v_2 = 0$ ) are used, the evader switching from one to the other, as Figure 7 shows. The results show the same general behavior as the exact solution. The discretization performed by the approximation on the control  $v$ , causes some troubles in the stabilizations of the trajectories about the semi-permeable line. In particular, the use of the Euler formula to integrate the differential equations produces cleaner switches than the fourth order Runge-Kutta method, because of the important number of switches required. In order for this vectogram approximation to be an optimal fit, the parameter  $a$  can be optimized. Dolezal [11] addresses this type of parameter

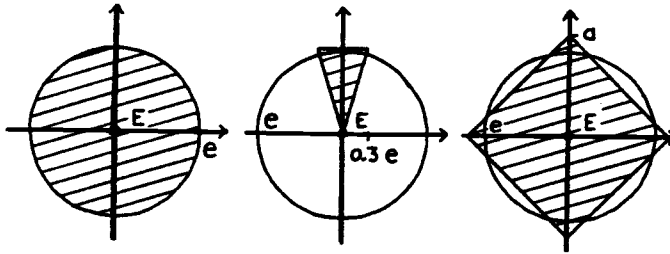

A. Original game. B. Bilinear approx. C. Square vectogram approx.

Figure 6. Vectogram approximations.

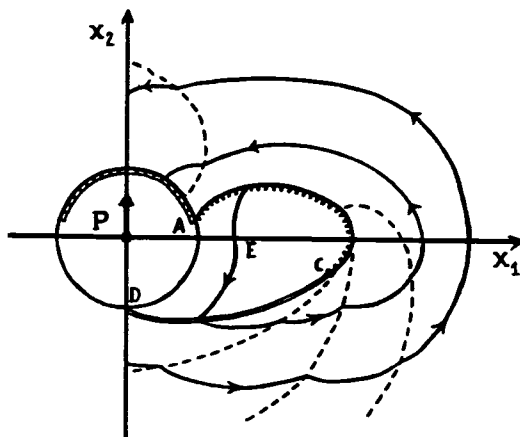





-  Usable part.
-  Optimal trajectory.
-  Semi-permeable line.
-  Switching line for  $u$ .
-  Switching line for  $v$ .

Figure 7. Square vectogram approximation of the homicidal chauffeur game.



optimization problem prior to the completion of a game. The performance index to be minimized may become complex. By changing the value of  $a$ , simulation shows that it seems to be always possible to approximate fairly closely parts of the exact solution, but significant deviations always occurred at some point.

The difficulties to approximate the equations of the homicidal chauffeur game are quite typical to the differential games. Linearizations around open-loop trajectories are hazardous since the other player may choose a tailored (closed-loop) strategy such that the result will significantly deviate. Local minimax properties cannot be claimed safely, due to this generic unstable behavior of differential games. Open-loop strategies are not interesting from a practical point of view. Closed-loop, or feedback strategies are more useful, not only because they allow to cope with uncertainties in the position, parameters, etc., but in order to recover from a deliberate non-optimal play of the opponent or to take advantage of an error committed by the other party. Minimum time, one-versus-one pursuit-evasion games, that have a convex terminal manifold can easily be studied globally, the trajectories being, in essence, closed loop. This is not the case of games involving a fixed terminal time or integral constraints on the controls or states. In this latter case, a particular trajectory corresponds to each point, a complete state-plane representation of the trajectories is impossible, and, in the event of a detected non-optimal play, a new open-loop solution must be recomputed.

The classical method uses the calculus of variations to solve the game of degree, thus, the game of kind must have been solved first.

Hence the weakness of the method proposed so far, that requires a qualitative study beforehand. A global study of the problem has been suggested, applying the Lyapunov theory operating together with dynamical systems. Unfortunately, quoting Skowronski [12], the qualitative study is still at an infancy stage.

Classical results are extended by Simaan and Cruz [13] to the continuous games in which the state is available only at discrete instant of time, when Regade and Sarma [14] show that the optimal payoff of linear differential games under partial observation is not altered from the complete observation case, an obvious property of open-loop policies.

#### 3.4 Two-pursuer-one-evader homicidal chauffeur game

Two-pursuer-one-evader homicidal chauffeur games amenable to a solution by ways of simple heuristic geometrical considerations are studied here, in an attempt to demonstrate what can be done without any thorough or even partial study of team games.

The reversed one-versus-one homicidal chauffeur game is solved classically as above; cases where the two pursuers are symmetrically disposed according to the orientation of the evader, are investigated. A direct pursuit occurs when E is located on the median of  $P_1P_2$ , and properly oriented, according to Figure 8. Then, the game is symmetrical and the optimal play for E is to move straight along  $x_2$ . This particular two-versus-one homicidal chauffeur game is equivalent to the one-versus-one case of the "wall pursuit game" in Isaacs [3], where E, constrained to  $x_2$ , is chased by  $P_1$  alone. Trivial geometrical considerations are used to solve that game according to Figure 9.

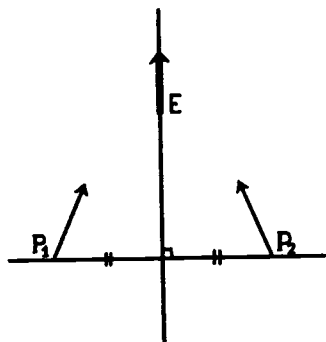

Figure 8. The direct pursuit case.

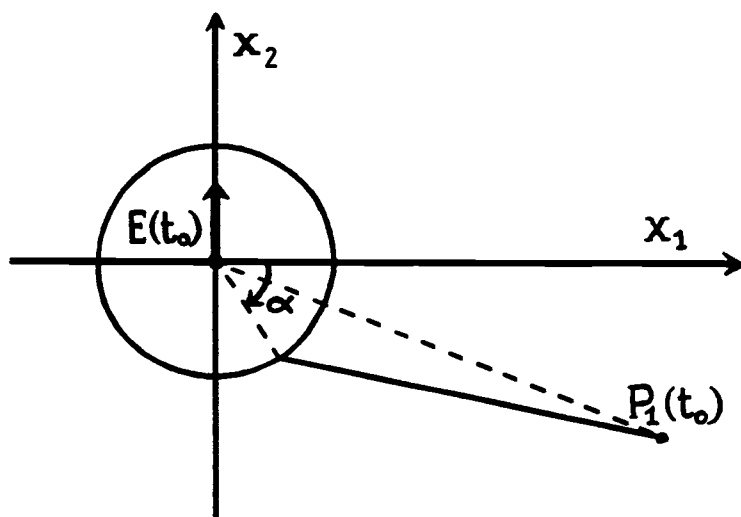
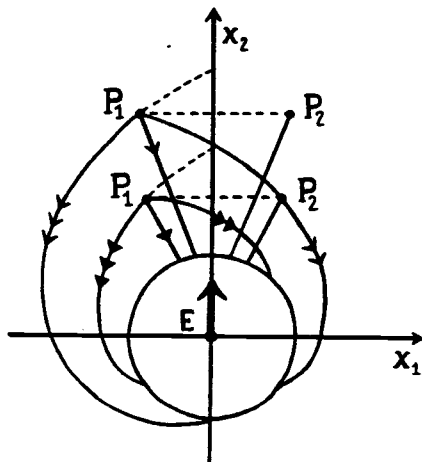

Figure 9. The wall pursuit game.

A collision dilemma arises whenever E and the symmetrical pair face each other. Then, E must compare its payoff for two strategies: going straight ahead or turning either right or left, as sharp as possible. If E decides to turn, say to the right, he will favor one of the pursuers, namely  $P_1$ , and the game will be concluded by that very pursuer. Though inactive,  $P_2$  is responsible for having forced E to turn towards  $P_1$  and not away from him. That optimal trajectory is given by the one-versus-one game in which the regressive path trajectories from the terminal hit points, are not stopped from symmetry reasons, along the axis  $x_2$ . Two examples of the collision dilemma to be solved by E are shown in Figure 10.









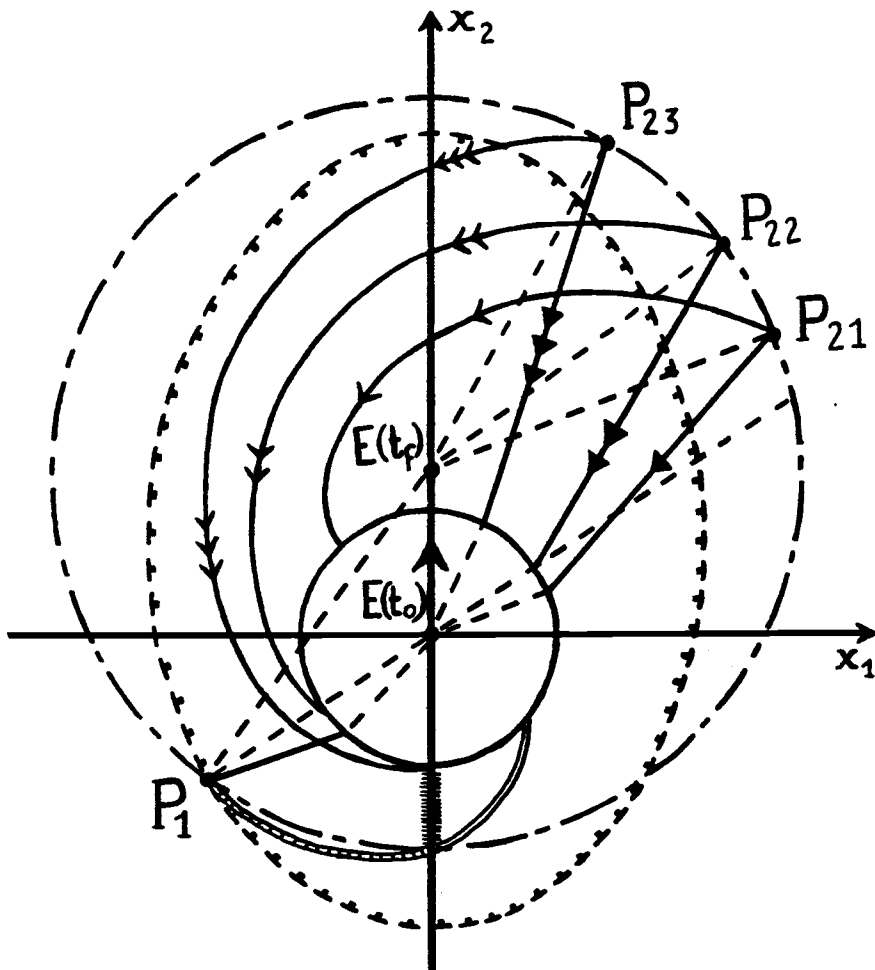

→→→	$P_1$ alone . . . . .	$t_f = 2.67$	} E must turn.
→→	$P_1 \& P_2$ , E turns . . . . .	$t_f = 2.09$	
→	$P_1 \& P_2$ , E moves straight:	$t_f = 1.74$	
→→→	$P_1$ alone . . . . .	$t_f = 1.34$	} E must move straight.
→→	$P_1 \& P_2$ , E turns . . . . .	$t_f = 1.02$	
→	$P_1 \& P_2$ , E moves straight:	$t_f = 1.07$	

Figure 10. The collision dilemma.

When the pursuers are not symmetrically disposed, a straight optimal trajectory of E is possible if  $P_1$  and  $P_2$  are located on the circle of center  $(0, et_f)$  and radius  $(r+t_f)$ . Then, E oriented away from the line  $P_1P_2$  is an obvious condition to ensure the straight line play. For  $P_1$  fixed, three possible situations can arise, depending on the location of  $P_2$  along the circle, two of which are solved, i.e. the straight-line play and the sharp-turn play, when the third situation corresponds to a "moderate" turn of E. Figure 11 depicts these three possibilities.

Even though a wide variety of cases can be solved using simple considerations as above, a method to solve general situations for team games is wanting.



- 
 $P_1$  alone . . . . . :  $t_{f1} = 3.05$  (1)
- 
 $P_1$  if E always turns right:  $t_{f2} = 2.70$
- 
 $P_1 \& P_{21}$ , E turns right. . . :  $t_{f3} = 1.97$  (2)
- 
 $P_1 \& P_{21}$ , E moves straight . :  $t_{f4} = 2.25$
- 
 $P_1 \& P_{22}$ , E turns right. . . :  $t_{f5} = 2.47$  (3)
- 
 $P_1 \& P_{22}$ , E moves straight . :  $t_{f4} = 2.25$
- 
 $P_1 \& P_{23}$ , E turns right. . . :  $t_{f6} = 3.17$  (4)
- 
 $P_1 \& P_{23}$ , E moves straight . :  $t_{f4} = 2.25$

- (1) one-versus-one game.
- (2) E moves straight, caught by  $P_1$  and  $P_{21}$ .
- (3) E turns right, caught by  $P_{22}$ .
- (4) E turns slightly to the right ( $t_{f6} > t_{f2}$ ), caught by  $P_1$  and  $P_{23}$ .

Figure 11. Three particular asymmetrical games.

### III. INTRODUCTION TO TEAM DIFFERENTIAL GAMES

#### 1. INTRODUCTION

Not very many team games are analyzed in the literature; to name a few, Isaacs [3] derives sufficient conditions in order for a team of patrollers to block a channel, Hagedorn and Breakwell [15] study the game in which a fast evader attempts to pass between two pursuers, dividing the game into two distinct phases, one in which the three players move in a straight course, and one in which the evader stays at a constant distance from its closest pursuer.

The same partitioning of the game into distinct phases allowed Foley and Schmitendorf [16] to solve a differential game with two pursuers and one evader, but in a non-zero sum game formulation, with a performance index for each pursuer. On the other hand, linear one-pursuer, one-evader games are studied by Pshenichnyi, Chikrii and Rappoport [17], with a unique performance index, but where all pursuers must capture the evader individually, and thus the evader strives against the slowest pursuer. These team games are solved because a convenient mapping from the one-versus-one game is possible, not unlike the example of the two-pursuer one-evader homicidal chauffeur game in the previous chapter.

Together with a discussion of the major difficulties in the statement of team differential games, this chapter formally applies the calculus of variations to derive the necessary conditions of optimality for team differential games.

## 2. FACTORS TO CONSIDER TO STATE A TEAM GAME

In most practical situations, the controls are physically bounded, notable exceptions being systems without inertia that are controlled directly through their heading angle as in the homicidal chauffeur game. Unbounded controls are more suitable to derive the feedback strategies and to avoid the switching functions that come together with bang-bang controls, hence the popularity of quadratic performance indices that provide a self-limitation in the controls. However, not every type of quadratic game is suitable to a deterministic pursuit-evasion game study. As an example, the following bilinear quadratic game has a relative state

$$\dot{\mathbf{x}} = \mathbf{Ax} + \mathbf{Bxu} + \mathbf{Cv} , \quad (28)$$

a quadratic performance index

$$J = \frac{1}{2} \int_{t_0}^{t_f} ( \|u\|_R^2 - \|v\|_S^2 ) dt , \quad (29)$$

and capture is achieved whenever the evader is forced within the circle of radius  $r$ . A complete study of this two player game would show that the capture zone is finite and that the Nash equilibrium strategies within that zone are  $u = v = 0$ . Thus, either capture is impossible, or it is bound to happen, such that no action is to be taken by either player. It is quite a paradox to find such a trivial solution to such a seemingly complex game. The difficulty is in the merging of the pursuit-evasion concept with the quadratic performance index. If capture only matters, the value of the control used by the evader becomes infinite, but so would immediately be the pursuer's



control. It would achieve the same result as choosing  $u = v = 0$  but for a possibly different value of  $J$ . This is an example of a game in which the perfect information structure prevents any evolution and hampers the interpretation of the results.

It seems that a better approach is to apply integral constraints on the controls. The first effect is to allow only open-loop solutions since, in most cases, the players try to spend their whole control capabilities and then, capture zones, singular behaviors etc, become very fuzzy. If the bilinear quadratic game above is used as a representation of the homicidal chauffeur game, according to the previous chapter, then, the controls are, in fact, angles, and the very definition of an integral constraint of an angle is rather peculiar. On the other hand, the previous chapter shows that substitution of the original controls by a vectogam approximation is an unsafe manipulation for differential games.

An easy generalization from the one-versus-one games can be done if the performance indices of the team games include summations of the controls, states, etc.- merely adding the various energies etc. spent by the team. While no particular problems arise for minimum-time team games, and even quadratic team games, fixed terminal-time games that include a terminal miss distance are more difficult to generalize since the distance between the evader and the closest pursuer is to be considered. Thus, most fixed terminal-time team games include a cumbersome minimum operator in their performance index as

$$J = \int_{t_0}^{t_f} (\min_i g(x_i(t)) + L(u_i, v, t)) dt, \quad (30)$$

where the reduced state equation for that game is

$$\dot{x}_i = f(x_i, u_i, v, t) \quad (31)$$

for pursuer  $P_i$ , and  $x_i$  is the relative distance between the evader E and  $P_i$ . An equivalent form for a two-versus-one game is

$$J = \int_{t_0}^{t_f} (wg(x_1(t)) + (1-w)g(x_2(t_f)) + L(u_i, v, t)) dt \quad (32)$$

by introducing the switching variable  $w$ , such that

$$w = 1 \text{ for } g(x_1(t)) < g(x_2(t)) \text{ and} \quad (33)$$

$$w = 0 \text{ for } g(x_1(t)) \geq g(x_2(t)) .$$

$w$  can be viewed as a control variable belonging to a mythical minimizing third party, such that (33) is a Nash strategy. It can be shown that the equivalent game requires the adjunction of a state  $y$  such that

$$y = w(g(x_1(t)) - g(x_2(t))) , \quad (34)$$

and the new performance index is

$$J = y(t_f) + \int_{t_0}^{t_f} (g(x_2(t)) + L(x_i, u_i, v, t)) dt . \quad (35)$$

Here  $w$  is constrained to the interval  $[0,1]$ . Thus, the two-versus-one team game with the non-linear minimum operator in the performance index, is equivalent to a three-versus-one augmented team game with the simplified performance index (35).

Actually, it can be proved that  $N$ -versus-one team games in which a term such as  $\min(a_1, a_2, \dots, a_m)$  is included in the performance index,

where  $a_1, a_2, \dots, a_m$  are  $m$  independent linear functions of the states, are equivalent to simpler forms of  $(N + m - 1)$ -versus-one team differential games. If  $a_1, a_2, \dots, a_m$  are not linearly independent, then it is possible to find a set  $(b_1, b_2, \dots, b_e)$  of independent vectors such that for  $1 < m$ ,

$$\min (a_1, a_2, \dots, a_m) = \min (b_1, b_2, \dots, b_e) . \quad (36)$$

On the other hand, particular games for which the control of the evader affects independently  $(m-1)$  of the state components of the functions  $(a_1, a_2, \dots, a_m)$ , proceed according to  $m$  distinct phases: first  $E$  plays according to the "closest" pursuer in the sense of the minimum function, until a second pursuer is just as close, then,  $E$  plays to keep both pursuers equally distant until a third pursuer becomes equally distant and so on. At the terminal time,  $a_1 = a_2 = \dots = a_m$ . The games studied by Hagedorn and Breakwell [15] and Foley and Schmitendorf [16] belong to this category. If the above is not met, then chances are that, for some initial conditions,  $a_i < a_j$  holds for some pair  $i, j$ , thereby reducing the number of arguments of the minimum operator.

The proof of this theorem is rather easy and will not be presented here, it provides a technique to put team games under more classically tractable forms, at the expense of an increase in the dimensionality. In the sequel, team games are assumed to have been put under this form, thus, cumbersome minimum operators are not considered in further studies.

Another problem is the definition of the differential equations describing the game. In a pursuit-evasion game, only the relative

state between the evader and the pursuers is important in an unconstrained space. Therefore, there is no need to carry the equations of motion of every single player, when a so-called reduced state is simpler. The reduction is long recognized as one of the major steps in studying such a differential game as a pursuit-evasion game, as, for example, Pontryagin [18] shows clearly.

Nevertheless, various approaches are possible. First is the brute force manner whereby the equations describing the motion of each player are kept, at the expense of an unwelcomed increase in the dimensions of the game. Moreover, keeping track of the positions of the players and of their associated terminal manifolds is a lot more difficult, as the guessing of the terminal state, so important in the solution of the N-point boundary-value problems, using optimal control theory. An excellent way to avoid any trouble is to start from a reduced set of equations. Sometimes, a proper choice of coordinate systems can simplify the problem or the controls, but this depends on the type of study conducted.

### 3. NECESSARY CONDITIONS OF OPTIMALITY FOR GENERALIZED TEAM GAMES

#### 3.1 Presentation

In the following, the notations and the general method adopted are borrowed from Bryson and Ho [19]. The free terminal time game obeys the differential equations

$$\dot{x} = f(x, u, v, t) , \quad (37)$$

and  $x(t_0) = x_0$  is given. The unconstrained controls are  $u$  for the pursuer and  $v$  for the evader. State constraints

$$\psi(x(t_f), t_f) = 0, \quad (38)$$

are adjoined to the performance index by the set of Lagrange multipliers  $v_p$  and  $v_e$ . The more general non-zero sum game is studied; then the performance index for the pursuer takes the form

$$J_p = \phi_p(x(t_f), t_f) + v_p^T \psi(x(t_f), t_f) + \int_{t_0}^{t_f} (L_p(x, u, v, t) + \lambda_p^T (f(x, u, v, t) - \dot{x})) dt \quad (39)$$

and for the evader

$$J_e = -\phi_e(x(t_f), t_f) - v_e^T \psi(x(t_f), t_f) - \int_{t_0}^{t_f} (L_e(x, u, v, t) + \lambda_e^T (f(x, u, v, t) - \dot{x})) dt, \quad (40)$$

where  $\phi_e$  and  $\phi_p$  are terminal payoffs and  $L_e, L_p$  are integral functions. The Lagrange multipliers  $v_p$  and  $v_e$  have the dimensions of the vector  $\psi$ . From now on, the various arguments are omitted for brevity.

For minimum-time linear team games where only the pursuers that perform capture are present, the results derived by Pshenichnyi, Chikrii and Rappoport [17], further generalized by Satimov, Azamov and Khaidarov [20], can be referred to, stating sufficient conditions that ensure the existence of a solution in finite time.

### 3.2 Stationarity for the one-versus-one game

Stationarity of  $dJ_e$  and  $dJ_p$  is expressed taking into account differential changes in the terminal time.

For the pursuer, it yields

$$\begin{aligned}
 dJ_p = & \left( \frac{\partial \phi_p}{\partial t_f} dt + v_p^T \frac{\partial \psi}{\partial t} dt + \frac{\partial \phi_p}{\partial x} dx + v_p^T \frac{\partial \psi}{\partial x} dx \right) + (L_p)_{t_f} dt_f - (L_p)_{t_0} dt_0 + \\
 & (\lambda_p^T (f - \dot{x}))_{t_f} dt_f - (\lambda_p^T (f - \dot{x}))_{t_0} dt_0 + \int_{t_0}^{t_f} \left( \frac{\partial L_p}{\partial x} \delta x + \lambda_p^T \frac{\partial f}{\partial x} \delta x - \right. \\
 & \left. \lambda_p^T \delta \dot{x} + \left( \frac{\partial L_p}{\partial u} \delta u + \lambda_p^T \frac{\partial f}{\partial u} \delta u \right) + \left( \frac{\partial L_p}{\partial v} \delta v + \lambda_p^T \frac{\partial f}{\partial v} \delta v \right) \right) dt
 \end{aligned} \tag{41}$$

At time  $t = t_0$  and  $t = t_f$ ,

$$\lambda_p^T (f(x, u, v, t) - \dot{x}) = 0, \tag{42}$$

and, introducing the Hamiltonian

$$H_p = L_p + \lambda_p^T f, \tag{43}$$

together with the function

$$\Phi_p = \phi_p + v_p^T \psi, \tag{44}$$

(41) simplifies into

$$\begin{aligned}
 dJ_p = & \left[ \left( \frac{\partial \Phi_p}{\partial t} + L_p \right) dt_f + \frac{\partial \Phi_p}{\partial x} dx \right]_{t_f} - (L_p)_{t_0} dt_0 + \\
 & \int_{t_0}^{t_f} \left( \frac{\partial H_p}{\partial x} \delta x + \frac{\partial H_p}{\partial u} \delta u + \frac{\partial H_p}{\partial v} \delta v - \lambda_p^T \delta \dot{x} \right) dt.
 \end{aligned} \tag{45}$$

From Figure 12,

$$dx(t_f) = \delta x(t_f) + \dot{x}(t_f) dt_f, \tag{46}$$

$$\delta x = dx - \dot{x} dt$$

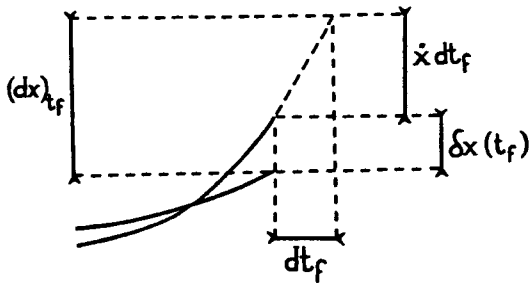

Figure 12. Terminal time differentials.

Then, integrating by parts, the following equality holds:

$$\int_{t_0}^{t_f} -\lambda_p^T \delta \dot{x} = -(\lambda_p^T \delta x)_{t_f} + (\lambda_p^T \dot{x} dt)_{t_f} + (\lambda_p^T \delta x) + \int_{t_0}^{t_f} \dot{\lambda}_p^T \delta x, \quad (47)$$

together with (45), it yields

$$dJ_p = \left( \frac{\partial \Phi_p}{\partial t} + L_p + \lambda_p^T \dot{x} \right)_{t_f} dt_f + \left( \left( \frac{\partial \Phi_p}{\partial x} - \lambda_p^T \right) \delta x \right)_{t_f} + (\lambda_p^T \delta x)_{t_0} - (L_p)_{t_0} dt_0 + \int_{t_0}^{t_f} \left( \left( \frac{\partial H_p}{\partial x} + \dot{\lambda}_p^T \right) \delta x + \frac{\partial H_p}{\partial u} \delta u + \frac{\partial H_p}{\partial v} \delta v \right) dt, \quad (48)$$

when a similar derivation yields

$$-dJ_e = \left( \frac{\partial \Phi_e}{\partial t} + L_e - \lambda_e^T \dot{x} \right)_{t_f} dt_f + \left( \left( \frac{\partial \Phi_e}{\partial x} + \lambda_e^T \right) \delta x \right)_{t_f} - (\lambda_e^T \delta x)_{t_0} - (L_e)_{t_0} dt_0 - \int_{t_0}^{t_f} \left( \left( \frac{\partial H_e}{\partial x} + \dot{\lambda}_e^T \right) \delta x + \frac{\partial H_e}{\partial u} \delta u + \frac{\partial H_e}{\partial v} \delta v \right) dt. \quad (49)$$

In order for the game to have a stationary value, the coefficients of  $dt_f$  and  $dx$  must vanish for both  $dJ_p$  and  $dJ_e$ , regardless of  $t$ . Therefore, these terms must be individually set to zero, that is

$$-\frac{\partial H_p}{\partial x} = \dot{\lambda}_p^T, \quad -\frac{\partial H_e}{\partial x} = \dot{\lambda}_e^T,$$

$$\left[ \frac{\partial \Phi_p}{\partial x} \right]_{tf} = (\lambda_p^T)_{tf}, \quad \left[ \frac{\partial \Phi_e}{\partial x} \right]_{tf} = (\lambda_e^T)_{tf}, \quad (50)$$

$$\left( \frac{\partial \Phi_p}{\partial t} + L_p + \lambda_p^T \dot{x} \right)_{tf} = \left( \frac{\partial \Phi_p}{\partial t} + H_p \right)_{tf} = 0, \quad \left( \frac{\partial \Phi_e}{\partial t} + L_e - \lambda_e^T \dot{x} \right)_{tf} =$$

$$\left( \frac{\partial \Phi_e}{\partial t} + H_e \right)_{tf} = 0$$

or, since

$$\frac{\partial \Phi_p}{\partial t} = \frac{d\Phi_p}{dt} - \frac{\partial \Phi_p}{\partial x} \dot{x}, \quad (51)$$

an equivalent condition is

$$\left( \frac{\partial \Phi_p}{\partial t} + L_p \right)_{tf} = 0, \quad \left( \frac{\partial \Phi_e}{\partial t} + L_e \right)_{tf} = 0. \quad (52)$$

Then, if the above holds,  $dJ_p$  and  $dJ_e$  are left to be

$$dJ_p = \int_{t_0}^{t_f} \left( \frac{\partial H_p}{\partial u} \delta u + \frac{\partial H_p}{\partial v} \delta v \right) dt + (\lambda_p^T dx)_{t_0} - (H_p)_{t_0} dt_0, \quad (53)$$

$$dJ_e = \int_{t_0}^{t_f} \left( \frac{\partial H_e}{\partial u} \delta u + \frac{\partial H_e}{\partial v} \delta v \right) dt + (\lambda_e^T dx)_{t_0} + (H_e)_{t_0} dt_0.$$



A stationary value for both  $J_p$  and  $J_e$  requires that

$$\frac{\partial H_p}{\partial u} \delta u + \frac{\partial H_p}{\partial v} \delta v = 0$$

and (54)

$$\frac{\partial H_e}{\partial u} \delta u + \frac{\partial H_e}{\partial v} \delta v = 0 .$$

The Nash equilibrium strategy is defined by

$$\frac{\partial H}{\partial u} = 0 \text{ with } v = v^* \text{ given}$$

and (55)

$$\frac{\partial H}{\partial v} = 0 \text{ with } u = u^* \text{ given .}$$

It achieves the desired stationarity, but it must be understood that the controls  $u^*$ ,  $v^*$  that satisfy the above are candidates that must also verify the Nash inequality:

$$\forall u \in U \quad H_p(u^*, v^*) \leq H(u, v^*) ,$$

and (56)

$$\forall v \in V \quad H_e(u^*, v) \leq H(u^*, v) .$$

The necessary conditions applied to the one-versus-one differential game define a two-point boundary-value problem. For a generalized pursuit-evasion game,  $\phi_p = \phi_e = \phi$ ,  $L_p = L_e = L$  hold and the equations describing the terminal manifold are usually one-dimensional; then,  $v_p$  and  $v_e$  are scalars, moreover  $\lambda_p = -\lambda_e$ ,  $v_p = -v_e = v$  and  $H_p = -H_e = H$ .

Then, together with the Nash inequality, the necessary conditions of optimality are

$$\left(\frac{\partial \phi}{\partial t} + v \frac{\psi}{\partial t} + L + \lambda^T \dot{x}\right)_{tf} = \left(\frac{\partial \phi}{\partial t} + v \frac{\partial \psi}{\partial t} + H\right)_{tf} = 0$$

$$-\frac{\partial H}{\partial x} = \dot{\lambda}^T, \quad (57)$$

$$\left(\frac{\partial \phi}{\partial x} + v \frac{\partial \psi}{\partial x}\right)_{tf} = (\lambda^T)_{tf},$$

$$\frac{\partial H}{\partial u} = 0, \quad \frac{\partial H}{\partial v} = 0.$$

### 3.3 Stationarity for the N-versus-one team game

For the team game opposing the pursuers  $P_i$  to E according to the state differential equations

$$\dot{x}_i = f_i(x_i, u_i, v, t) \quad (58)$$

$J_p$  and  $J_e$  are defined as

$$J_p = \sum_i \phi_{P_i}(x(t_f), t_f) + \sum_i v_{P_i}^T \psi_i + \int_{t_0}^{t_f} (L_{P_i} + \sum \lambda_{P_i}^T (f_i - \dot{x}_i)) dt, \quad (59)$$

$$J_e = -\sum_i \phi_{E_i}(x(t_f), t_f) - \sum_i v_{E_i}^T \psi_i + \int_{t_0}^{t_f} (-L_{E_i} + \sum \lambda_{E_i}^T (f_i - \dot{x}_i)) dt.$$

and the Hamiltonians are

$$H_p = L_p + \sum_i \lambda_{P_i}^T f_i,$$

$$H = -L_e + \sum_i \lambda_{E_i}^T f_i, \quad (60)$$

when the relation between the one-versus-one and the N-versus-one game is

$$L_p = \sum_i (L_{p_i} - L_{pv_i}) + L_{pv} , \quad (61)$$

$$L_e = \sum_i (L_{e_i} - L_{ev_i}) + L_{ev} ,$$

with, in the one-versus-one case of  $P_i$ -vs.-E:

$$J_{p_i} = \phi_{p_i}(x_i(t_f), t_f) + v^T \psi_{p_i}(x_i(t_f), t_f) + \int_{t_0}^{t_f} (L_{p_i u_i}(x_i, u_i, t) + L_{pv_i}(x_i, v, t) + \lambda_{e_i}^T (f_i - \dot{x}_i)) dt , \quad (62)$$

$$J_e = \phi_{e_i}(x_i(t_f), t_f) + v^T \psi_{e_i}(x_i(t_f), t_f) + \int_{t_0}^{t_f} (L_{e_i u_i}(x_i, u_i, t) - L_{ev_i}(x_i, v, t) + \lambda_{e_i}^T (f_i - \dot{x}_i)) dt.$$

A step by step derivation identical to the one conducted in the two player case, yields the necessary conditions of optimality for the team games, as

$$\begin{aligned} \left( \frac{\partial \Phi_{p_i}}{\partial t_f} + L_p + \sum \lambda_{p_i}^T x_i \right)_{t_f} &= 0 , \quad \left( \frac{\partial \Phi_{e_i}}{\partial t_f} + L_e - \sum \lambda_{e_i}^T x_i \right)_{t_f} = 0 \\ - \frac{\partial H_{p_i}}{\partial x_i} &= \dot{\lambda}_{p_i}^T , \quad - \frac{\partial H_{e_i}}{\partial x_i} = \dot{\lambda}_{e_i}^T , \end{aligned} \quad (63)$$

$$\left( \frac{\partial \Phi_{p_i}}{\partial x_i} \right)_{t_f} = (\lambda_{p_i}^T)_{t_f} , \quad \left( \frac{\partial \Phi_{e_i}}{\partial x_i} \right)_{t_f} = (\lambda_{e_i}^T)_{t_f} ,$$

$$\frac{\partial H_{p_i}}{\partial u_i} = 0 \text{ if } v^* \text{ given, } \sum_i \frac{\partial H_{e_i}}{\partial v} + \frac{\partial L_{ev}}{\partial v} - \sum_i \frac{\partial L_{ev_i}}{\partial v} = 0 \text{ if } u^* \text{ given,}$$

in which some equations are expressed N times, one for each pursuer.

For this team game, the Nash strategy is expressed as

$$J_p(u_1^*, u_2^*, \dots, u_N^*, v^*) \leq J_p(u_1, u_2, \dots, u_N, v^*)$$

$$\forall (u_1, u_2, \dots, u_N) \in U_1 \cdot U_2 \dots U_N, \quad (64)$$

$$J_e(u_1^*, u_2^*, \dots, u_N^*, v) \leq J_e(u_1, u_2, \dots, u_N, v^*) \quad \forall v \in V,$$

when, in the general N-player case, it would have been

$$(\forall i \in 1, \dots, N) J(u_1^*, \dots, u_{i-1}^*, u_i, u_{i+1}^*, \dots, u_N^*) \leq$$

$$J(u_1^*, \dots, u_{i-1}^*, u_i, u_{i+1}^*, \dots, u_N^*), \quad (\forall u_i \in U_i) \quad (65)$$

The distinction between a team game and an N-player game appears clearly.

For a generalized team pursuit-evasion game,  $\phi_{p_i} = \phi_{e_i} = \phi_i$ ,  $L_p = L_e = L$  and  $\psi$  has dimension one. Then  $\lambda_{p_i} = -\lambda_{e_i} = \lambda_i$  and  $-v_{e_i} = v_{p_i} = v_i$ .

The necessary conditions of optimality are summarized below:

$$\left( \sum_i \left( \frac{\partial \phi_i}{\partial t} + v_i \frac{\partial \psi_i}{\partial t} \right) + H \right)_{t_f} = 0, \quad - \frac{\partial H_i}{\partial x_i} = \dot{\lambda}_i^T,$$

$$\left( \frac{\partial \phi_i}{\partial x_i} + v_i^T \frac{\partial \psi_i}{\partial x_i} \right)_{t_f} = (\lambda_i^T)_{t_f}, \quad \frac{\partial H}{\partial u_i} = 0, \quad \frac{\partial H}{\partial v} = 0. \quad (66)$$

The first equation in (66) can only determine one of the  $N$  scalars  $v_i$ . The remaining scalars must be chosen so that the solution to the equations matches the initial conditions of the game. The  $(N-1)$  unknowns, called strategic variables are defined as

$$v z_i = v_i, z_1 = 1. \quad (67)$$

Utilizing this formulation, the first equation in (66) is used to determine the unique Lagrange multiplier  $v$ .

The strategic variable  $z_i$ , is such that, when  $z_i$  is small,  $P_i$  has nearly no effect on the game as seen from (43) and because  $\lambda_i$  has a module proportional to  $z_i$ . On the other hand, if  $z_i$  is large, then,  $P_i$  is more important than other players. Thus, there is a clear relation between the importance of a pursuer and the value of its strategic variable. Conversely, the value of  $z_i$  can be used a-posteriori as a selecting device to choose the relevant players to simplify a game and to compute approximate solutions.

The strategic variable is not constant when the evader is surrounded by the pursuers. That possibility exists whenever there are at least  $N$  pursuers for an evader moving on a space of dimensions  $(N-1)$ . Then  $z_i$  adopts a value such that the control of the evader disappears from the Hamiltonian.

The main problem in solving the team games, with this approach, is to guess properly the strategic variables. The capturability and playability conditions can be used to restrict the domain of definition of  $z_i$ . When a given level of cooperation is required from a pursuer, the value of its associated strategic variable is necessarily

restricted. However, finding the exact value of the strategic variable  $z_i$  usually requires a painstaking trial and error procedure. Thus a formula to give a first approximation of  $z_i$  is desired. The correspondence between  $z_i$  and the effect of the pursuers suggests formulae such as

$$z_i = \frac{(P_1 E)}{(P_i E)} \quad (68)$$

or

$$z_i = \frac{(P_1 E - r_1)/p_1}{(P_i E - r_i)/p_i} \quad (69)$$

where  $P_i E$  is the distance separating the evader from pursuer  $P_i$ , of maximum speed  $p_i$ .

Also, it can be shown easily that, under favorable initial conditions, two slow pursuers can catch a faster evader. Also, if the one-versus-one game  $(P_1, E)$  admits a solution from  $x_1(t_f)$ , then, the two-versus-one game with  $x_1(t_f)$  is possible under any value of the strategic variable. Conversely, for any pair  $(x_1(t_f), x_2(t_f))$ , there exists a value of the strategic variable such that the necessary conditions of optimality are satisfied. Then, it is clear that restricted usable parts of terminal manifolds can no longer be found and, consequently, the convenient use of the singularities to study the boundary of the usable part, barriers, capture zones and particular trajectories do not apply to team pursuit-evasion games.

Feedback solutions can only be given relatively to the other pursuer, thus, the added dimension due to the strategic variable prevents the global solution to be represented by a unique state

portrait, since trajectories corresponding to different values of  $z_i$  do intersect.

The most crucial point in this study is that an N-pursuer team game is not a classical (N+1) point boundary value problem because another (N-1) unknowns, modelled as strategic variables, are to be found. The team of pursuers minimizes a common performance index; it defines a single Hamiltonian for the team, and then, whenever a pursuer is added to the team, one equation is missing. Nevertheless, the general structure of the equations enables one to take advantage of the individual 1-vs.-1 games to derive structures of team games.

## IV. THE GAME OF KIND

1. INTRODUCTION

By analogy with the 1-vs.-1 game, the game of kind study for team differential pursuit-evasion games could be summarized by finding the answer to the question "can the pursuit team catch the evader in finite time?" Sufficient conditions ensuring the existence of a control to achieve capture in finite time are stated by Satimov, Azamov and Khaidarov [20]. But another dimension to the game of kind has to be added, and the next question is "which are the relevant pursuers?" In other words, how to distinguish the pursuers whose presence is required from those whose effect on the optimal solution is null.

A pursuer  $P_i$ , attempting to capture an evader  $E$ , is expecting some cooperation from other pursuers. Fixing  $P_i$ , it is convenient to partition the space into various zones in which a copursuer would be expected to behave in a particular way. As the game proceeds, the zones evolve dynamically. The possible zones of interest are numerous, therefore the pursuers will be assumed to play optimally, reducing the number of the zones of interest.

After the various definitions of the zones for the minimum time problem, a parallel with the game of degree allows computation of the most useful zones, the help zones. Approximated formulae are also of interest since the computation of the exact zones is, at best, difficult. Finally, an example is treated to illustrate the procedure.



## 2. PURSUER CLASSES

Generally, three classes of pursuers can be distinguished as follows:

i) The first is made of the pursuers that are irrelevant to the game because of their initial position, their dynamical characteristics (speed, maneuverability, etc.) or because other pursuers are located in positions that completely cover the possibilities of these pursuers.

ii) The second class includes the pursuers that have a temporary effect on the game. The typical example is a very slow pursuer located on the course of the evader. This pursuer will deny a direct course, but once passed, its effect will be null. State constraints like islands can be modeled as a pursuer of speed equal to zero, with a lethal area covering the island.

iii) The third class consists of the pursuers that actually perform the capture. It is often implicitly assumed that the pursuers belong to this class.

The three classes must be studied in both events: an optimal as well as a non-optimal play of the evader. The actual control that a pursuer should adopt in the (unlikely) event that the evader would not play optimally, when such an optimal play of the evader would not allow this pursuer to be useful, is difficult to find since the very definition of the criteria to optimize is problematic.

The study of class two partitions the game into several sequences divided by time  $t_s$  from which the pursuer of class two has no

effect any more. Very often, the evader is on the border of the lethal area of this pursuer at time  $t_s$ .

The global study of the game of kind helps in finding the conditions under which capture is possible. These conditions on the relative speeds and maneuverability, ensure capture independently of the initial state (capture condition) or not (playability condition). Under particular initial conditions, it is possible for two slow pursuers to catch a faster evader.

### 3. TWO-VERSUS-ONE PURSUIT-EVASION ZONES

The zones represent a parametric study of the pursuit-evasion game. Many parameters are candidates but the one used is the initial position of an eventual copursuer. Thus, the other parameters such as the position of the evader at  $t = t_0$  and the characteristics of the various players are assumed to be known. Another assumption is the optimality of the strategies of the pursuers.

The specific pair  $(P_i, P_j)$  is separately studied. To a pursuer  $P_i$ , six zones, corresponding to six possible cases, are relevant. The following notations are used:

$x_i^T M_i x_i \leq r_i^2$  is the capture condition corresponding to pursuer  $P_i$ .

The control vector of pursuer  $P_i$  is  $u_i$ , defined on the set of admissible control functions  $U_i$ . The control of the evader is  $v$ , defined on  $V$ . Usual definitions of  $U_i$  and  $V$  are the set of control vectors bounded by a given maximum norm.

$t_{P_i}^*(v)$  is the capture time of the one-versus-one game  $(P_i, E)$ ,

where  $E$  applies the control  $v$ , and  $P_i$ , initially located at  $x_i(t_0)$ , plays optimally.  $v^*$  is the optimal strategy of  $E$ . To each pair  $(v, x_i(t_0))$  thus corresponds a time  $t_{P_i}^*(v)$ .

$t_{P_j}^*(v^*) > t_{P_i}^*(v^*)$  means that the optimal game  $(P_j, E)$  finishes in a longer time than the optimal game  $(P_i, E)$ . Then  $P_i$  is a more dangerous player than  $P_j$  and  $z_i < z_j$  is likely in the 2-vs.-1  $(P_i, P_j, E)$  game. Note that one of the times  $t_{P_j}^*(v^*)$  or  $t_{P_i}^*(v^*)$  may be infinite if the corresponding pursuer is unable to catch, alone, the evader.

$Z1P_{j0}(\bar{P}_i/P_j^*)$  is to be interpreted as zone number 1 where the parameter of study is the position of pursuer  $P_j$  at time  $t = t_0$ , in which  $P_j$  is located such that  $P_i$  has no effect on the game, given that  $P_j$  plays optimally.

In the following,  $x_i(t_0)$  is given and the parameter describing the zones is the initial position  $x_j(t_0)$  of an eventual copursuer.

$$i) Z1P_{j0}(\bar{P}_i/P_j^*) = \{x_j(t_0) \mid x_i^T(t)M_i x_i(t) > r_i^2, \forall v \in V, \forall t \in$$

$$[t_0, t_{P_j}^*(v)], \forall u_i \in U_i\}.$$

If  $P_j$  belongs to this zone at  $t = t_0$ , and the game  $(P_j, E)$  is finished in  $t_{P_j}^*(v)$ , then  $P_i$  will not play any role in any game involving  $P_j$ , provided that  $P_j$  plays optimally. In this game, a strategic variable associated with  $P_i$  is  $z_i = 0$ , and  $P_i$  is of class one as defined earlier.

$$\text{ii) } Z2P_{j0}(\tilde{P}_i/P_j^*) = \{x_j(t_0) \mid x_i^T(t)M_i x_i(t) > r_i^2, \forall u_i \in U_i,$$

$$\forall t \in [t_0, t_{P_j}^*(v^*)], \text{ and } \exists u_i \in U_i, \exists v \in V,$$

$$\exists t \in [t_0, t_{P_j}^*(v)]; x_i^T(t)M_i x_i(t) \leq r_i^2 \} .$$

$P_i$  cannot catch an evader playing optimally according to  $P_j$  but there exists at least one play of the evader that would enable  $P_i$  to capture before  $P_j$  does.  $P_i$  can play a role in a game involving  $P_j$  only if  $E$  does not play optimally or if the presence of other pursuers forces  $E$  to deviate from the  $(P_j, E)$  optimal strategy. If pursuer  $P_i$  is of class two as defined earlier, then  $P_i$  is able to intercept the trajectory of the 1-vs.-1  $(P_j, E)$  game in the prescribed time otherwise  $P_i$  would not be able to deny the evader a course. The fact that  $P_i$  might not achieve capture is here irrelevant: the other member of the team, namely  $P_j$ , will do it; the question is to know if  $P_i$  plays a role in the team effort. A pursuer  $P_i$  of class two belongs to the next zone.

$$\text{iii) } Z3P_{j0}(\tilde{P}_i/P_j^*) = \{x_j(t_0) \mid \exists u_i \in U_i, \exists t \in [t_0, t_{P_j}^*(v^*)];$$

$$x_i^T(t)M_i x_i(t) \leq r_i^2 \text{ and } t_{P_j}^*(v^*) < t_{P_i}^*(v^*) \} .$$

If  $P_j$  belongs to this zone, then  $P_i$  will play a role in the  $(P_i, P_j, E)$  game, in which  $P_j$  is the primary threat.

$$\text{iv) } Z4P_{j0}(\tilde{P}_j/P_i^*) = \{x_j(t_0) \mid \exists u_j \in U_j, \exists t \in [t_0, t_{P_i}^*(v^*)];$$

$$x_j^T(t)M_j x_j(t) \leq r_j^2 \text{ and } t_{P_i}^*(v^*) < t_{P_j}^*(v^*) \} .$$

If  $P_j$  belongs to this zone, then  $P_j$  will play a role in the  $(P_i, P_j, E)$  game, in which  $P_i$  is the primary threat. A pursuer of class three would belong to Z3 or Z4.

$$v) \quad Z5P_{j0}(\tilde{P}_j/P_i^*) = \{x_j(t_0) \mid x_j^T(t)M_jx_j(t) > r_j^2, \forall u_j \in U_j, \forall t \in$$

$$[t_0, t_{P_i}^*(v^*)] \text{ and } \exists u_j \in U_j, \exists v \in V, \exists t \in$$

$$[t_0, t_{P_i}^*(v)]; x_j^T(t)M_jx_j(t) \leq r_j^2\} .$$

$P_j$  cannot catch an evader playing optimally according to  $P_i$  but there exists at least one play of the evader that would enable  $P_j$  to capture before  $P_i$  does. If  $P_j$  belongs to this zone, then  $P_j$  can play a role in a game involving  $P_i$  only if  $E$  does not play optimally or if the presence of other pursuers forces  $E$  to deviate from the  $(P_i, E)$  optimal strategy.

$$vi) \quad Z6P_{j0}(\bar{P}_j/P_i^*) = \{x_j^T(t)M_jx_j(t) > r_j^2, \forall u_j \in U_j, \forall v \in V,$$

$$\forall t \in [t_0, t_{P_i}^*(v)]\} .$$

If  $P_j$  belongs to this zone, then  $P_j$  will not play any role in any game involving  $P_i$ , provided that  $P_i$  plays optimally. In this zone, the strategic variable  $z_j$  associated with  $P_j$  is zero, and  $P_j$  is of class one.

Section 6. shows an example of the derivation of these zones for the problem of the cutters vs. railroad.

The definitions above concern the 2-vs.-1 game  $(P_i, P_j, E)$ . The zones are the same for every pursuer identical to  $P_j$  but depend on

the position  $x_i(t_0)$  of  $P_i$  at  $t = t_0$ , i.e. to a new initial position  $x_i(t_0)$  corresponds a completely new set of zones. The same kind of definitions can be derived for a three-vs.-one game as:

$Z1P_{ko} (\bar{P}_k/P_i^*, P_j^*)$  etc. The derivation of these zones is, of course, more complex than in the two-pursuer-versus-one evader game.

In solving a N-pursuer game, it is hoped that the simple case by case study of the zones associated with the possible pairs allows selection of the relevant players.

#### 4. THE HELP ZONE

The help zone  $HP_{jo} (P_i^*, E) = Z1 \cup Z2 \cup Z3 \cup Z4$  is the zone in which  $P_j$  plays a role in the  $(P_i, P_j, E)$  game where  $P_i$  and  $E$  play optimally.

The first way to compute the boundary of the help zone is by remarking that this boundary separates the optimal 2-vs.-1 game  $(P_i, P_j, E)$  in which  $P_j$  plays a role with the 2-vs.-1 game in which  $P_j$  does not play a role; this latter game is, thus, equivalent to the 1-vs.-1 game  $(P_i, E)$ , since  $P_j$  is irrelevant. Therefore, if pursuer  $P_j$ , at  $t = t_0$ , is located on this boundary, then the equations of the necessary conditions of optimality describing the 2-vs.-1  $(P_i, P_j, E)$  game and the equations describing the 1-vs.-1  $(P_j, E)$  game both hold, and consequently, the boundary of the help zone is determined by all the possible  $x_j(t_0)$  that satisfy these conditions. Then all the equations must be jointly solved; this control approach seems heavy, but is easily shown to be equivalent to the solution of the equations of the 2-vs.-1 game and letting the strategic variable  $z_j$  approach zero, since  $P_j$  has less and less influence while reaching the boundary

of the help zone, beyond which  $P_j$  becomes useless. This is a relatively easy task. That smooth transition between the 1-vs.-1 and the 2-vs.-1 games is ensured by  $z_j$ . The absence of the strategic variable prevents any attempt to define a help zone for fixed terminal-time games.

The second way to derive the help zone is a gaming approach. The Hamiltonian of the 2-vs.-1 game is  $H$ , and the Hamiltonians of the 1-vs.-1 games  $(P_i, E)$  and  $(P_j, E)$  are  $H_i, H_j$ . Then it is always possible to set  $H = H_i + H_j + C_{ij}$  where  $C_{ij}$  is a correction term such that the equality holds. If  $P_j$  collaborates with  $P_i$  in the capture, then  $H \neq H_j$  must hold. Thus,  $H_j + C_{ij} \neq 0$  is the cooperation condition, and conversely,  $H_j + C_{ij} = 0$ , with the controls  $u_i^*$  from the 1-vs.-1 game, gives the boundary of the help zone. Though different in their approaches, both methods are, in fact, equivalent.

##### 5. APPROXIMATIONS OF THE NO-HELP ZONE

Zone Z6 is important because a pursuer located in zone Z6 of another pursuer can immediately be eliminated. Unfortunately, if the derivation of the help zone is more or less possible, Z6 is more difficult to compute since a non-optimal play of the evader (optimal in the 2-vs.-1 sense) must be accounted for.

From the definition of Z6 given above, three simplifications that yield approximated results can be made.

$$i) Z6P_{j0}(\bar{P}_j/P_i^*) = \{ x_j(t_0) | y_j^T(t) M_j y_j(t) > r_j^2, \forall u_j \in U_j,$$

$$\forall t \in [t_0, t_{P_i}^*(v^*)] \},$$

where  $y_j$  is the state vector corresponding to the Pareto game  $(P_j, E)$  in which  $E$  is willing to be caught (rendez-vous game).  $y_j(t)$  obeys the same dynamics as  $x_j(t)$  and  $y_j(t_0) = x_j(t_0)$ , but during the development of the game, the evader uses its control  $v$  to help  $P_j$  in the capture. If  $P_j$  is not in the area of constant terminal time  $t_{P_j}^*(v^*)$  in the Pareto game  $(P_j, E)$ , then  $P_j$  belongs to  $Z6$ . The idea is that  $(P_i, E)$  lasts at most  $t_{P_i}^*(v^*)$ ; if the game  $(P_j, E)$ , with the cooperation of  $E$ , cannot be ended within this time, then, for sure,  $P_j$  cannot help  $P_i$  in catching  $E$ .  $Z63$  is, of course, a coarse approximation of  $Z6$ ; also  $Z63 \subset Z6$ .

$$\text{ii) } Z62P_{j0}(\bar{P}_j/P_i^*) = \{x_j(t_0) \mid y_j^T(t)M_j y_j(t) > r_j^2, \forall u_j \in U_j, \\ \forall v \in V, \forall t \in [t_0, t_{P_i}^*(v^*)]\},$$

where  $y_j$  is the state vector corresponding to the Pareto game  $(P_j, E)$ .  $Z62$  uses the same approach as  $Z63$ , but now,  $E$  is constrained to the reachable zone of the evader allowed by  $P_i$ . In the 1-vs.-1 game  $(P_i, E)$  where  $P_i$  plays optimally,  $E$ , playing all the possible policies  $v$ , can cover, before capture, a zone named reachable zone of the evader allowed by  $P_i$ , and the largest time to capture is  $t_{P_j}^*(v^*)$ . In  $Z62$ ,  $E$  is constrained to this zone that  $P_j$  attempts to reach.  $Z62$  is a better approximation than  $Z63$  at the expense of some more computation;  $Z63 \subset Z62 \subset Z6$ .

$$\text{iii) } Z61P_{j0}(\bar{P}_j/P_i^*) = \{x_j(t_0) \mid y_j^T(t)M_j y_j(t) > r_j^2, \forall u_j \in U_j, \\ \forall v \in V, \forall t \in [t_0, t_{P_i}^*(v)]\},$$



where  $y_j$  is the state vector corresponding to the Pareto  $(P_j, E)$  game. In Z61, E is also constrained to its reachable zone but the exact time  $t_{P_i}^*(v)$  allowed by  $P_i$ , associated with every policy  $v$  of E, is computed and fixes the maximum duration of the Pareto game  $(P_j, E)$  during which  $P_j$  attempts to reach E.

For those game in which the 1-vs.-1 game  $(P_i, E)$  lasts long enough compares with the inertia of  $P_j$ , a major simplification can be made if the control  $u_j$  considered is fixed to be a trajectory orthogonal to the trajectory of the evader at time  $t_{P_i}^*(v^*)$ .

Z63 is to be used when  $t_{P_i}^*(v^*)$  only is available, Z62 when the reachable zone of E according to the 1-vs.-1 game  $(P_i, E)$  is known, and Z61 when the exact timing of this reachable zone is known.

## 6. TWO-CUTTERS VS. RAILROAD EXAMPLE

### 6.1 Time-optimal conditions

The cutters  $P_i$  attempt to intercept in minimum time a train E, constrained on a railway (axis  $x_2$ ). The lethal area of the cutters is a circle of radius  $r_i$ ; the cutters of speed  $P_i$  control their heading angle  $u_i$ , and the evader controls its speed  $v$ , bounded by  $e$ . The 1-vs.-1 version of this game has been referred to as "the wall pursuit game" by Isaacs [3], or sometimes as "ICBM vs. railroad". Due to its simplicity, this game can be solved geometrically or using control theory. The important case where E is between or surrounded by its two opponents as well as its implications on the strategic variable  $z_2$  ( $z_1 = 1$ ) are investigated.

The game of kind will be studied through two examples.

The Hamiltonian, the optimal policies  $(u_i^*, v^*)$ , the costate vectors  $\lambda_i = (\lambda_{i1}, \lambda_{i2})$  and the states  $(x_i)$  are given by

$$H = -\lambda_{11}p_1 \cos(u_1) + \lambda_{12}(v-p_1 \sin(u_1)) - \lambda_{21}p_2 \cos(u_2) + \lambda_{22}(v-p_2 \sin(u_2)) + 1, \quad (70)$$

$$\cos(u_i^*) = \lambda_{i1} / \sqrt{\lambda_{i1}^2 + \lambda_{i2}^2}, \quad (71)$$

$$\sin(u_i^*) = \lambda_{i2} / \sqrt{\lambda_{i1}^2 + \lambda_{i2}^2},$$

$$v^* = e \cdot \text{sign}(\lambda_{12} + \lambda_{22}),$$

where "sign" is the signum function,

$$\begin{aligned} \dot{\lambda}_{i1} &= 0, \\ \dot{\lambda}_{i2} &= 0, \end{aligned} \quad (72)$$

$$\text{at } t = t_f \quad \lambda_{11} = v_1 r_1 \cos(\alpha_1), \quad \lambda_{21} = v_2 r_2 \cos(\alpha_2),$$

$$\lambda_{12} = v_1 r_1 \sin(\alpha_1), \quad \lambda_{22} = v_2 r_2 \sin(\alpha_2),$$

$$\text{and} \quad z_2 v_1 r_1 = v_2 r_2,$$

$$x_{i1} = r_i \cos(\alpha_i) + \tau p_i \cos(\alpha_i), \quad (73)$$

$$x_{i2} = r_i \sin(\alpha_i) + \tau p_i \sin(\alpha_i) - \tau e \cdot \text{sign}(\sin(\alpha_i)) + \tau e C_i,$$

$$\text{with} \quad C_i = 1 \cdot \text{sign}(\sin(\alpha_i)) - 1 \cdot \text{sign}(\sin(\alpha_i) + z_2 \sin(\alpha_2));$$

$\alpha_i$  are line of sight angles relative to  $x_2$  axis at the terminal time;  $\tau$  is defined as  $t_f - t$ . The strategic variable  $z_2$  appears in (73) only in a signum function, therefore has a switching effect.

The capture condition is expressed by

$$P_1 + z_2 P_2 - e |\sin(\alpha_1) + z_2 \sin(\alpha_2)| \geq 0. \quad (74)$$

Three inequalities restrict the strategic variable: the capture condition, expressed at the terminal time and the playability conditions applied to each pursuer, which state that the trajectories, as  $\tau$  increases from zero, must go away from the terminal manifold. Defining  $\vec{d}_i$  as the tangent vector to the trajectory at time  $\tau = t_f - t$ , this geometrical condition is expressed by

$$\vec{d}_i = (x_{i1} - r_i \cos(\alpha_i) ; x_{i2} - r_i \sin(\alpha_i)) , \quad (75)$$

$$(x_{i1} - r_i \cos(\alpha_i)) \cos(\alpha_i) + (x_{i2} - r_i \sin(\alpha_i)) \sin(\alpha_i) \geq 0 .$$

The strategic variable is not constant when, for example, the common opponent is surrounded by the pursuers. That possibility exists whenever a team of at least  $N$  members faces an opponent moving on a space of dimension  $N - 1$ . Then  $z_i$  adopts a value such that the control of the evader,  $v$ , disappears from the Hamiltonian at the last moments of the game.

## 6.2 Game of kind analysis

The trajectories are given by (73), the limit of the help zone for  $P_1$  is obtained by letting  $z_2$  approach zero in the trajectory (73)

for  $P_2$ . The result is given below; the variable is  $\alpha_2$ ,  $\tau = t_f$  and  $\alpha_1$  are given by the 1-vs.-1 game  $(P_1, E)$ .

$$x_1 = r_1 \cos(\alpha_2) + \tau p_2 \cos(\alpha_2) \quad , \quad (77)$$

$$x_2 = r_2 \sin(\alpha_2) + \tau p_2 \sin(\alpha_2) - \tau e \cdot \text{sign}(\sin(\alpha_1)) \quad ,$$

From the above computations, various significant zones of capture and help for location of  $P_2$  at  $t = t_0$ , may be computed, relative to  $x_1(t_0)$ . For example, with  $p_1 = e$ ,  $e = 1$ ,  $r_1 = 1$ ,  $r_2 = 0.5$  and  $x_1(t_0) = (4 ; -4)$ . Figure 13 presents the zones for  $p_2 = 1.5$  and Figure 14, for  $p_2 = 0.5$ , is an example where  $P_2$  is unable to capture  $E$  in the game  $(P_2, E)$  and  $t_{P_2}^*(v^*)$  is infinite.  $Z_6$ , the zone of capture by  $P_1$  alone, is the most difficult to calculate. The three approximations are computed according to their definitions in Section 5.

The interval given by  $x_2 \in [3.95, -1.79]$  in Figures 13 and 14 provides the segment that  $E$  can reach when  $P_1$  plays optimally.

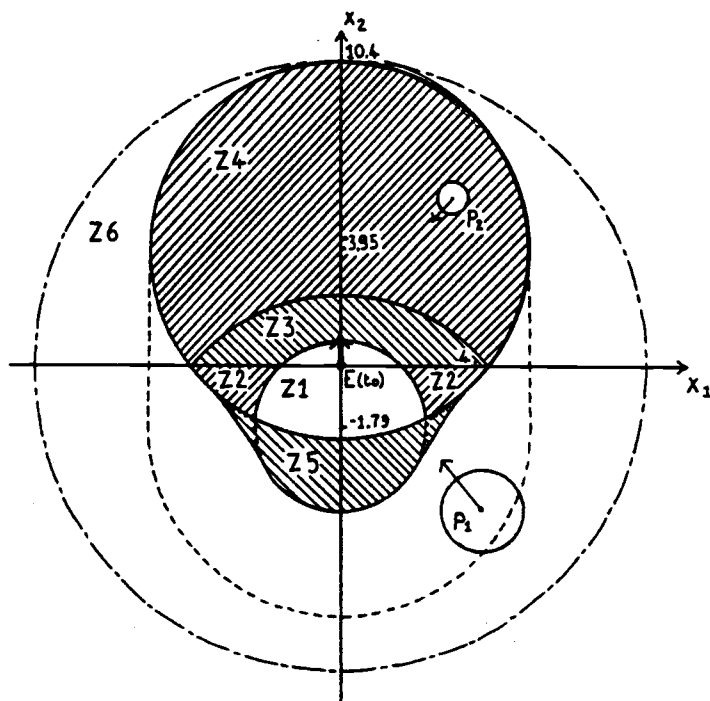

$$e < p_2 < p_1$$

- Z1:  $P_2$  alone will capture E.
- Z2:  $P_2$  alone will capture an optimal E.
- Z3:  $P_2$  will be helped by  $P_1$  in capturing E.
- Z4:  $P_1$  will be helped by  $P_2$  in capturing E.
- Z5:  $P_1$  alone will capture an optimal E.
- Z6:  $P_1$  alone will capture E.

Approximations of Z6:

- Z61.
- Z62.
- Z63.

Figure 13. Cooperative zones for 2-vs.-1 example with pursuer speed  $p_2 = 1.5$ .

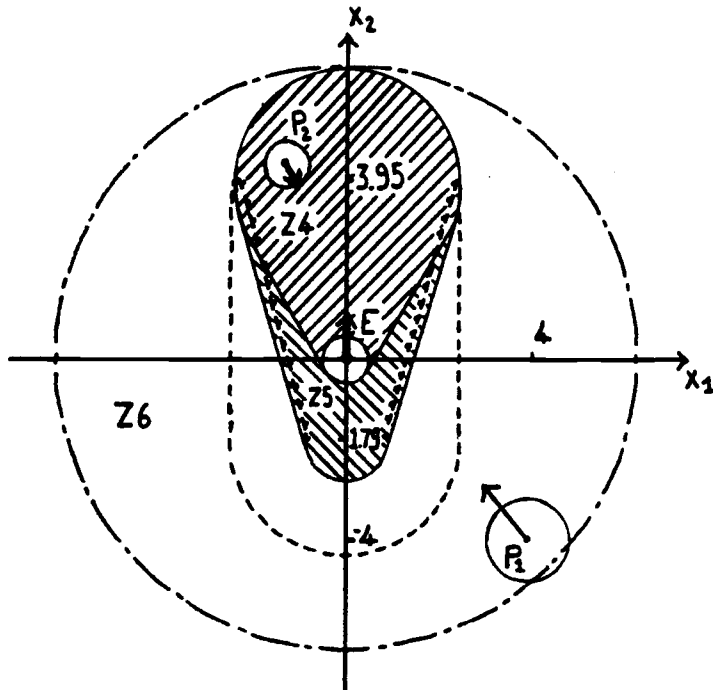

$$p_2 < e < p_1$$

Z1, Z2, Z3 are identical to the capture area of  $P_2$ .

Z4:  $P_1$  will be helped by  $P_2$  in capturing E.

Z5:  $P_1$  alone will capture an optimal E.

Z6:  $P_1$  alone will capture E.

Approximations of Z6:

- · - · - Z61.

- - - - - Z62.

- - - - - Z63.

Figure 14. Cooperative zones for 2-vs-1 example with pursuer speed  $p_2 = 0.5$ .

## V. THE LINEAR QUADRATIC GAME OF DEGREE

### 1. THE QUADRATIC TEAM GAMES

The hierarchical command and communication structure for a linear quadratic game of  $N$  pursuers and 1 evader is derived. The optimal solution and a simpler form of this solution are given yielding the general solution to the  $N$ -pursuer vs. one-evader game. A sensitivity study leads to a simple hierarchical structure which greatly reduces the amount of computation required.

Two-player, linear, quadratic games have been extensively studied in the literature. According to Clemhaut and Wan [21], conceptually, a linear quadratic model may be regarded as a Taylor approximation to more general models. Another advantage is that, computationally, the closed-loop control can, in principle, be numerically determined.

On the other hand, two main disadvantages must be overcome. A quadratic objective function implies satiability at some finite state vector. Unbounded controls make any pursuit-evasion, game-of-kind type of analysis impossible. More importantly, even for a two-person, two-state problem, the solution involves a Ricatti system including six second-order differential equations.

Team games emphasize these disadvantages; the very definition of the performance index actually defines the type of cooperation between teammates; this issue is addressed in Chapter VII. The game becomes an  $N+1$  point, boundary-value problem involving heavily

interrelated Ricatti equations and has a complex hierarchical structure.

## 2. 1-vs.-1 LINEAR QUADRATIC GAME OF DEGREE

The game studied is a linear, quadratic, generalized N-pursuer, one-evader game with the reduced state given by

$$\dot{x}_i = A_i x_i + B_i u_i + C_i v, \quad (78)$$

where  $i = 1, 2, \dots, N$ ;  $x_i \in \mathbb{R}^n$ ,  $u_i \in \mathbb{R}^n$  is the control of pursuer  $P_i$  and  $v \in \mathbb{R}^n$  is the control of the evader;  $A_i$ ,  $B_i$ ,  $C_i$  are matrices of appropriate dimension.

The terminal condition is given by a manifold  $g(x_i(t_f)) \leq 0$  or again more specifically

$$x_i^T(t_f) M_i x_i(t_f) \leq r_i^2, \quad (79)$$

and the performance index, to be minimized by the pursuers and maximized by the evader, is

$$J = 0.5 \int_{t_0}^{t_f} (\sum_i (x_i^T Q_i x_i + u_i^T R_i u_i) - v^T S v) dt, \quad (80)$$

where  $M_i$ ,  $Q_i$ ,  $R_i$ ,  $S$  are appropriate, positive definite, symmetric matrices.

Let  $\lambda_i \in \mathbb{R}^n$  be the costate vector required by the game solution with the minimum principle such that the transversality condition is given by the relation

$$\lambda_i(t_f) = v z_i M_i x_i(t_f), \quad (81)$$



where  $\nu$ , a Lagrange multiplier, satisfies the terminal Hamiltonian

$$H(t_f) = [\sum_i (A_i x_i + B_i u_i + Cv)^T \lambda_i - \frac{1}{2} \sum_i (x_i^T Q_i x_i + u_i^T R_i u_i) + \frac{1}{2} \nu^T S \nu]_{t_f} = 0 \quad (82)$$

The strategic variable,  $z_1 = 1$  for a 1-vs.-1 game, and it can be assumed that  $z_1 = 1$  (most effective pursuer) and  $z_j < 1$  for  $j = 2, \dots, N$  in general.

The open-loop Nash solution according to the minimum principle for the one-pursuer case ( $i=1$ ) is given by

$$\begin{aligned} u_i^* &= R_i^{-1} B_i^T T_i \Phi_i(t, t_0) x_i(t_0), \\ v^* &= S^{-1} C_i^T T_i \Phi_i(t, t_0) x_i(t_0), \end{aligned} \quad (83)$$

where the state transition matrix,

$$\begin{aligned} \dot{\Phi}_i(t, t_0) &= (A_i + N_i T_i + L_i T_i) \Phi_i(t, t_0), \\ \Phi_i(t, t) &= I, \\ N_i &= B_i R_i^{-1} B_i^T, \quad L_i = C_i S^{-1} C_i^T; \end{aligned} \quad (84)$$

$T_i$  is the solution to the matrix Riccati equation,

$$\begin{aligned} \dot{T}_i &= -A_i^T T_i - T_i A_i - T_i (N_i + L_i) T_i + Q_i, \\ T_i(t_f) &= \nu z_i M_i. \end{aligned} \quad (85)$$

The solution is classical. The non-zero-sum game formulation, in which P and E do not have a similar performance index is treated by Mohler, Kolodziej and Bugnon [22]. The vector  $\lambda_i$  and the matrix  $T_i$  are duplicated; (85) becomes a system of coupled Ricatti equations. A procedure to decouple the Ricatti equations is given by Simaan and Cruz [23], taking advantage of a preliminary solution common to several initial conditions, reducing the problem to the computation of successive linear equations.

A complete derivation of the two-player, linear, quadratic game is given by Ichikawa [24] and Hämäläinen [25].

### 3. TWO-vs.-ONE-GAME SOLUTION

The two-pursuer, one-evader game requires two costate vectors with transversality condition (81) for  $i = 1, 2$ .  $u_i^*$ ,  $i = 1, 2$ , is given by (83) and

$$v^* = S^{-1} \left[ \sum_{i=1}^2 C_i^T T_i \Phi_i(t, t_0) x_i(t_0) \right], \quad (86)$$

The state transition matrices are given by (84), and  $H(t_f)$  by (82).

$T_i$  on the other hand, is computed from

$$\begin{aligned} \dot{T}_1 x_1 &= [-T_1 A_1 - A_1^T T_1 - T_1 (N_1 + L_1) T_1 + Q_1] x_1 - T_1 C_1 S^{-1} C_2^T T_2 x_2, \\ \dot{T}_2 x_2 &= [-T_2 A_2 - A_2^T T_2 - T_2 (N_2 + L_2) T_2 + Q_2] x_2 - T_2 C_2 S^{-1} C_1^T T_1 x_1, \end{aligned} \quad (87)$$

where  $T_1(t_f) = \nu z_1 M_1$ ,  $T_2(t_f) = \nu z_2 M_2$ .

The solution is very complex compared to the 1-vs.-1 game. The differential systems, (84) and (87), are tightly coupled, requiring parallel computation whereas the solution to the 1-vs.-1 game could proceed in several steps.

$z_2$  must be selected properly to correspond to the initial conditions of the game. It might require a trial and error procedure whose computational burden would be somewhat reduced using the method described by Simaan and Cruz [23].

By analogy with the strategic variable, a strategic matrix  $Z_i$  is defined as a symmetric, non-singular matrix satisfying the relation

$$Z_i^T T_1 x_1 = T_i x_i, \quad (88)$$

and  $Z_1 = I$ .

The solution, while (85) and (86) provide  $u, v^*$ , is given by

$$\begin{aligned} \dot{T}_1 &= -T_1 A_1 - A_1^T T_1 - T_1 (N_1 + L_1) T_1 - T_1 C_1 S^{-1} C_2^T Z_2 T_1 + Q_1, \\ \dot{T}_2 &= -T_2 A_2 - A_2^T T_2 - T_2 (N_2 + L_2) T_2 - T_2 C_2 S^{-1} C_1^T Z_2^{-1} T_2 + Q_2, \end{aligned} \quad (89)$$

with  $T_1(t_f) = v z_1 M_1$ ,

$$T_2(t_f) = v z_2 M_2,$$

$$\dot{Z}_2 = Z_2 (A_1^T + Q_1 T_1^{-1}) - (A_2^T + Q_2 T_2^{-1}) Z_2, \quad (90)$$

$$\dot{Z}_2^{-1} = Z_2^{-1} (A_2^T + Q_2 T_2^{-1}) - (A_1^T + Q_1 T_1^{-1}) Z_2^{-1},$$

and  $Z_2(t_f)M_1x_1(t_f) = (z_2/z_1)M_2x_2(t_f)$ ,

$$Z_2^{-1}(t_f) = [Z_2(t_f)]^{-1}$$

The similarities with the 1-vs.-1 game are now obvious; the equations are decoupled and can be solved in turn. However, the problem of guessing the strategic variable remains. Note the simplification that  $Q_1 = Q_2 = 0$  would introduce.

#### 4. STRUCTURE OF AN N-IDENTICAL-PURSUER, ONE-EVADER LINEAR QUADRATIC GAME

The solution for  $Q=0$  takes the form given by

$$u_i^* = B^T T_i x_i, \quad (91)$$

$$v^* = C \sum_{i=1}^N T_i x_i,$$

$$\dot{T}_i = -T_i A - A^T T_i - T_i (N+L) T_i - T_i L \left( \sum_{j \neq i}^{1,N} Z_j \right) Z_i^{-1} T_i, \quad (92)$$

and  $T_i(t_f) = \nu z_i M$ ,  $\nu$  given by  $H(t_f) = 0$ ,

$$\dot{Z}_i = Z_i A^T - A^T Z_i, \quad (93)$$

$$\dot{Z}_i^{-1} = Z_i^{-1} A^T - A^T Z_i^{-1},$$

with  $Z_i(t_f)Mx_1(t_f) = (z_i/z_1) Mx_i(t_f)$

$$Z_i^{-1}(t_f) = [Z_i(t_f)]^{-1}.$$

The summation sign ( $\Sigma$ ) on the control of the evader  $v^*$ , and the independence of the controls  $u_i^*$  as well as the form of the solution show that each pursuer  $P_i$  needs to receive information about

the optimal control,  $v^*$ , about the strategic matrices  $Z_j$  and the strategic variables  $z_j$  in order to carry out its own optimization algorithm. This results in  $u_i$  while providing information about  $T_i x_i$  (to compute  $v^*$ ),  $x_i(t_f)$  (to compute  $Z_i$ ), and  $J_i = \frac{1}{2} \int_{t_0}^{t_f} (u_i^T R_i u_i) dt$  (to compute  $z_i$  and  $z_j$ ).

It can be viewed as the nesting of three hierarchical structures that must iteratively be optimized, going from the lowest one to the highest one. Figure 15 shows that structure.

First, according to a given pair  $(Z_i, z_i)$ , the loop involving AL1 is taken into account, each pursuer producing  $x_i(t_f)$ . Then, according to these  $x_i(t_f)$ , the new  $Z_i$  are to be computed by AL2 according to (93), and so on until the point where the new values of  $Z_i$  match the old ones. As a last step,  $J_i$  are analyzed in AL3 to produce the new strategic vector  $z = [z_1, z_2, \dots, z_N]$ . Consequently,

i) AL1 is purely deterministic:  $v^* = C \sum_{i=1}^N T_i x_i$ .

ii) AL2 is tactical: the main strategic option being defined by the strategic vector  $z$ , AL2 merely computes the trajectories, etc. to perform the capture.  $\sum_{j \neq i}^{1, N} Z_j$  must be computed according to the differential equations given for  $Z_j$  which depend on  $x_j(t_f)$ . An algorithm that ensures the convergence of  $Z_j$  to yield the values of  $x_j(t_f)$  produced by the pursuers, must be added.

iii) AL3 is strategical. The values in the strategic vector define early strategical choices viz. which is the most important player representing the main threat to be considered by the evader, which are the irrelevant pursuers (of class one), etc...  $z_i$  must be determined according to both the a priori information and the a posteriori information based on  $J_i$  for the previous vector  $z$ .

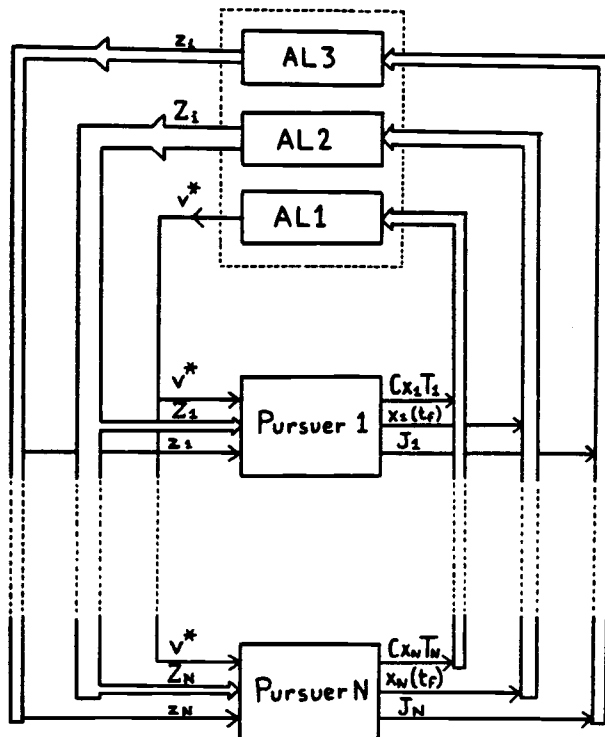

Figure 15. Nesting hierarchical structure for N-vs.-1 linear quadratic game.

AL1 is known; AL2 is a simple converging algorithm, but so far, little is developed to avoid an exhaustive search for AL3.

A few rules in finding AL3 are as follows:

- i) Study the game of kind, trying to select the relevant pursuers to the game.
- ii) Attempt to guess the value of  $z_i$  according to the initial positions and some simple geometric rules.
- iii) The capturability and playability conditions that must be satisfied by  $z_i$ , delimit the hyper-volume of definition of the vector  $z$ .
- iv) A heuristic decomposition approach to the solution that will be introduced in the next chapter.

## 5. A SUB-OPTIMAL STRUCTURE

Equation (92) can be redefined as

$$\dot{T}_i + -T_i A - A^T T_i - T_i (N + L) T_i - \beta_i - \omega_i, \quad (94)$$

if

$$\beta_i = T_i L \left( \sum_{j=1}^{i-1} z_j \right) z_i^{-1} T_i, \quad (95)$$

$$\omega_i = T_i L \left( \sum_{j=i+1}^N z_j \right) z_i^{-1} T_i.$$

Except for the addition of  $\beta_i$  and  $\omega_i$  in (94) and the summation sign in (91), the N-vs.-1 game solution is identical to the 1-vs.-1 solution.

This suggests a sensitivity study of both  $\beta_i$  and  $\omega_i$ . In some instances the  $\beta_i$  are nearly equal and the  $\omega_i$  are negligible when the pursuers represent equal threats to the evader. In this case, the difference between the 1-vs.-1 game and n-vs.-1 game is seen to

come hardly from the controls adopted by the pursuers but from the controls adopted by the evader.  $\beta_i$  is an important term if  $P_i$  plays a minor role in the capture. On the other hand, for all cases considered,  $\omega_i$  is negligible when the playability condition is not violated, provided that the pursuers be classified in order of importance,  $P_1$  being the most important one (the closest one to E for the minimum-time problems).

Consequently, the result is shown in Figure 16, where each pursuer solves (91) - (93), finding the couple  $x_i(t_f)$ ,  $z_i$  corresponding to  $x_i(t_0)$ , and passes this information forward.

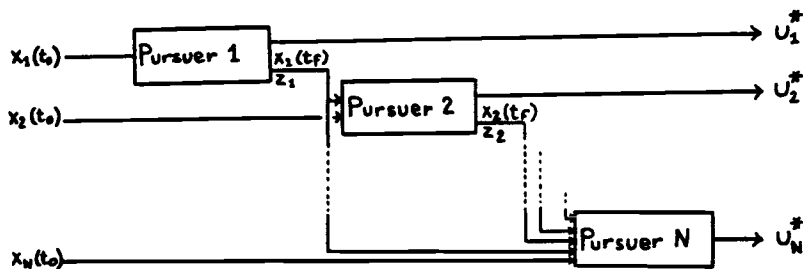

Figure 16. Sub-optimal simple field hierarchical structure for the N-vs.-1 linear quadratic game.



This structure takes advantage of the autonomy of the pursuers, breaks the complex solution into simpler steps, and, to an individual pursuer, the number and class of the co-pursuers is completely irrelevant.

The previous structure of Figure 15, though exact, is inferior in that the search of the optimal solution is quite tedious, AL3, in particular, is vague. The information passed (matrices  $Z_i$ , vectors  $z$  and  $x_i$ ,  $Cx_iT_i$ ) is substantial compared to the new structure.

A parallel structure is derived from this "ripple" structure in Figure 17, enhancing the independence of the individual pursuers with respect to the team, but at the expense of an increased number of equations to solve. A "minor" pursuer can be added but the gain produced by this pursuer must be weighted against the amount of delay or computation that this very pursuer will have to cope with.

The structure depicted in Figure 17, and implemented for the examples considered does not show any variation in state, control or performance superior to 0.1% of the rigorous solution.

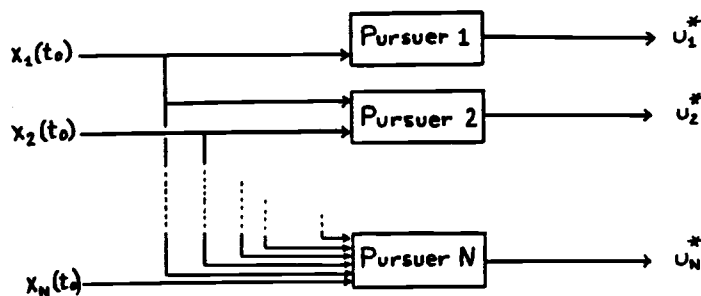

Figure 17. Independent hierarchical structure for the N-vs.-1 linear quadratic game.

## VI. A COMPOSITION APPROXIMATING ALGORITHM

### 1. INTRODUCTION

The main difficulty in solving an N-vs.-1 pursuit-evasion game, using the necessary conditions of optimality, is to guess properly various variables such as the terminal hit points and the strategic variables. This problem gets more and more difficult as the number of pursuers increases. The 1-vs.-1 problem, though complex, is often solvable whereas the 2-vs.-1 problem is nearly impossible to derive globally.

In this section, the solution to the 2-vs.-1 linear, minimum-time, team game is simplified using a composition approach. The two individual 1-vs.-1 games are assumed to be previously solved. The approach consists of the computing of an intermediate stage in which an "equivalent" 1-vs.-1 game is defined. The solution to this equivalent 1-vs.-1 game is used to find, in a similar way, the solution to the 2-vs.-1 game.

The study of the 2-vs.-1 game of kind done so far corresponds to a direct optimal approach. The direct composition is defined first; i.e., the problem addressed is how to compute the equivalent 1-vs.-1 game solution from the two 1-vs.-1 games.

The first step is to prove that such an equivalent game exists; therefore the composition is first derived analytically from the results of both the 1-vs.-1 and the 2-vs.-1 games.

## 2. ANALYTIC COMPOSITION

The computation of the initial position, dynamics and terminal manifold of pursuer  $P$  whose effect on the game studied  $(P,E)$  is identical to the effect of the pair  $(P_1, P_2)$ , is named composition.

Three major properties of the ideal composition must be relaxed:

i)  $P$  must be equivalent to  $P_1$  and  $P_2$  for every optimal and non-optimal play of the pursuers. So far, in every problem studied, the optimality of the pursuers was assumed since the main goal is to study the team and not the escape maneuvers. Thus, optimality will be assumed for the pursuers, even though a problem is to get rid of a non-optimal play of a  $(P_1, P_2, E)$  game that might, in fact, correspond to an optimal play of a  $(P_1, P_2, P_3, E)$  game.

ii)  $P$  must be equivalent to  $P_1$  and  $P_2$  for every optimal and non-optimal play of the evader. This is a reasonable request, but for the sake of simplicity, the evader will be assumed to behave optimally.

iii) To every position of  $P_1$  and  $P_2$  there corresponds a position of the equivalent pursuer  $P$ . Enforcing this property would solve the 2-vs.-1 game globally. The study of this functional will not be undertaken.

By composition, all the above simplifications are assumed. The scope of interest of the composition operator is considerably reduced, but, as shown, existence is the main obstacle to a broader definition.

In the following equations, the 2-vs.-1 game is written with indices when the equivalent 1-vs.-1 game has none. The pursuers are identical. The minimum-time problem, where  $v$ , the control of the evader, is constrained by  $|v| \leq V$  and  $u_i$ , the control of pursuer  $P_i$ , by  $|v_i| \leq U_i$ , is analyzed.

The reduced states, the Hamiltonians and the optimal controls are given by

$$\dot{x} = Ax + Bu + Cv,$$

$$\dot{x}_1 = Ax_1 + Bu_1 + Cv, \quad (96)$$

$$\dot{x}_2 = Ax_2 + Bu_2 + Cv,$$

$$H = \lambda^T(Ax + Bu + Cv) + 1, \quad (97)$$

$$H_{1,2} = \lambda_1^T(Ax_1 + Bu_1 + Cv) + \lambda_2^T(Ax_2 + Bu_2 + Cv) + 1$$

$$v_{1,2}^* = V \cdot \text{sign}((\lambda_1^T + \lambda_2^T)C), \quad (98)$$

$$v^* = V \cdot \text{sign}(\lambda^T C),$$

and the capture condition by

$$x^T(t_f) M x(t_f) \leq r^2. \quad (99)$$

By definition of the composition, in (99), both lines are identical. Thus,  $\lambda^T C$  and  $(\lambda_1^T + \lambda_2^T)C$  must be identical switching functions in order for the composition to exist.

A simple possible choice is

$$\lambda^T = k(\lambda_1^T + \lambda_2^T) , \quad (100)$$

in which  $k$  is a positive constant.

Both the 2-vs.-1 and the 1-vs.-1 game must verify the necessary conditions of optimality when (100) is verified.

The maximum principle, that gives the control policies, is obviously verified, the costate dynamics given by

$$\begin{aligned} \dot{\lambda}^T &= -\lambda^T A , \\ \dot{\lambda}_1^T &= -\lambda_1^T A , \\ \dot{\lambda}_2^T &= -\lambda_2^T A , \end{aligned} \quad (101)$$

do not conflict with the time derivative of (100) expressed as

$$\dot{\lambda}^T = k(\dot{\lambda}_1^T + \dot{\lambda}_2^T) . \quad (102)$$

At  $t = t_f$ , the transversality conditions

$$\begin{aligned} \lambda^T(t_f) &= v x^T M , \\ \lambda_1^T(t_f) &= v_{1,2} z_1 x_1^T M , \\ \lambda_2^T(t_f) &= v_{1,2} z_2 x_2^T M , \end{aligned} \quad (103)$$

must be verified; (100) and (103) yield

$$k(\lambda_1^T(t_f) + \lambda_2^T(t_f)) = v x^T M = v_{1,2} (z_1 x_1^T + z_2 x_2^T) k M , \quad (104)$$

or, defining

$$x_e(t) = z_1 x_1(t) + z_2 x_2(t) , \quad (105)$$

(104) becomes

$$v x_e^T(t_f) M = v_{1,2} x_e^T(t_f) k M , \quad (106)$$

where the Lagrange multipliers  $v_{1,2}$  and  $v$  must verify the terminal time conditions

$$H(t_f) = 0 , \quad (107)$$

$$H_{1,2}(t_f) = 0 .$$

It can be shown that the choice made in (100) is a valid choice, summarized by

$$x(t_f) = x_e(t_f)/a ,$$

$$-1/k = 2v_{1,2} (x_e^T M A x_e / a + x_e^T C v - x_e^T M B \text{Usign}(x_e^T M B)) , \quad (108)$$

$$a = \pm \sqrt{x_e^T(t_f) M x_e(t_f)} / r .$$

$a$  is chosen so that  $k$  is positive, and then,  $v = a k v_{1,2}$ .

Note that, in finding  $x(t_0)$ , the position of the equivalent pursuer at time  $t - t_0$ , only " $a$ " really matters. Thus, provided that the 2-vs.-1 game be solved first, finding the equivalent pursuer (i.e., composing) is an easy procedure for the linear system (96), (100) is, in particular, a valid choice.

### 3. AN APPROXIMATION PROCEDURE

The game is solved in two steps, according to Figure 18. The first step is to compute the 1-vs.-1 equivalent game, namely  $x(t_0)$  and  $z_2$  to find  $t_f$ ,  $v^*$  and then, as a second step, the complex 2-vs.-1 game is transformed into a two-dimensional, time-varying, one-sided control problem with fixed terminal time, much simpler to solve than the original game.

The procedure is mainly concerned with the so-called direct composition. The two main phases of the problem are to find  $x(t_0)$  and to estimate  $z_2$ .

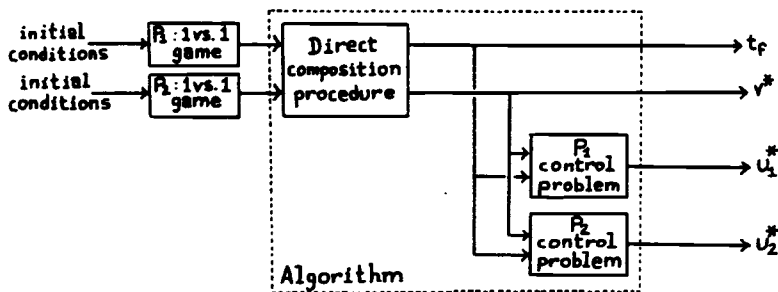

Figure 18. Composition approximating algorithm for 2-vs.-1 game.

The composition is performed using backward integration from a terminal hit point given by

$$\mathbf{x}(t_f) = \mathbf{x}_e(t_f)kv/v_{1,2} , \quad (109)$$

where  $\mathbf{x}_e$  is defined in (105). This relation merely expresses the colinearity between  $\mathbf{x}$  and  $\mathbf{x}_e$  at  $t = t_f$ , the constant term  $kv/v_{1,2}$  simply adjusts the modules in order to satisfy the terminal condition (99). If  $r = 1$  then it is readily seen that  $||\mathbf{x}_e(t_f)|| = v_{1,2}/(kv)$ .

Then, integrating backwards in time, the state of the 2-vs.-1 and the equivalent 1-vs.-1 games is given by

$$\mathbf{x}(t) = \Phi(t, t_f)\mathbf{x}(t_f) + \int_{t_f}^t \Phi(t, \tau)Bu(\tau)d\tau + \int_{t_f}^t \Phi(t, \tau)Cv(\tau)d\tau ,$$

$$\mathbf{x}_1(t) = \Phi_1(t, t_f)\mathbf{x}_1(t_f) + \int_{t_f}^t \Phi_1(t, \tau)Bu(\tau)d\tau +$$

$$\int_{t_f}^t \Phi_1(t, \tau)Cv(\tau)d\tau , \quad (110)$$

$$\mathbf{x}_2(t) = \Phi_2(t, t_f)\mathbf{x}_2(t_f) + \int_{t_f}^t \Phi_2(t, \tau)Bu(\tau)d\tau +$$

$$\int_{t_f}^t \Phi_2(t, \tau)Cv(\tau)d\tau ,$$

where  $\Phi$ ,  $\Phi_1$ ,  $\Phi_2$  are the corresponding state transition matrices, and  $A, B, C$  are time-invariant matrices.

$P$ ,  $P_1$  and  $P_2$  have the same homogeneous part in their differential equation (96), therefore

$$\Phi(t, t_f) = \Phi_1(t, t_f) = \Phi_2(t, t_f) = \exp(A(t - t_f)) . \quad (111)$$



The optimal controls are

$$\begin{aligned} u^* &= -U \cdot \text{sign}(\lambda^T B) , \\ u_1^* &= -U_1 \cdot \text{sign}(\lambda_1^T B) , \\ u_2^* &= -U_2 \cdot \text{sign}(\lambda_2^T B) , \end{aligned} \quad (112)$$

$$\begin{aligned} v^* &= V \cdot \text{sign}(\lambda_1^T C + \lambda_2^T C) , \\ v^* &= V \cdot \text{sign}(\lambda^T C) . \end{aligned}$$

Using

$$\lambda(t_f) = (x_1(t_f) + z_2 x_2(t_f))/a = x_e(t_f)/a , \quad (113)$$

with (100) and (110),  $U = U_1 = U_2 = 1$ ,  $V = 1$ , then

$$\begin{aligned} x(t) &= \exp(A(t-t_f))x(t_f) + \int_t^{t_f} \exp(A(t-\tau))B \cdot \text{sign}((\lambda_1^T + \lambda_2^T)B) d\tau \\ &\quad - \int_t^{t_f} \exp(A(t-\tau))C \cdot \text{sign}((\lambda_1^T + \lambda_2^T)C) d\tau , \end{aligned} \quad (114)$$

is derived. (114) can be expressed as

$$\begin{aligned} x(t) &= \exp(A(t-t_f))x_1(t_f)/a + \int_t^{t_f} \exp(A(t-\tau))B \cdot \text{sign}(\lambda_1^T B) d\tau/a \\ &\quad - \int_t^{t_f} \exp(A(t-\tau))C \cdot \text{sign}((\lambda_1^T + \lambda_2^T)C) d\tau/a \\ &\quad - z_2 \int_t^{t_f} \exp(A(t-\tau))C \cdot \text{sign}((\lambda_1^T + \lambda_2^T)C) d\tau/a \\ &\quad + z_2 \exp(A(t-t_f))x_2(t_f)/a \end{aligned} \quad (115)$$

$$\begin{aligned}
& + z_2 \int_t^{t_f} \exp(A(t-\tau)) B \cdot \text{sign}(\lambda_2^T B) d\tau / a \\
& + \int_t^{t_f} \exp(A(t-\tau)) B (\text{sign}((\lambda_1^T + \lambda_2^T) B) - \text{sign}(\lambda_1^T B) / a \\
& - z_2 \text{sign}(\lambda_2^T B) d\tau / a - \int_t^{t_f} \exp(A(t-\tau)) C (\text{sign}((\lambda_1^T + \lambda_2^T) C) \\
& - \text{sign}((\lambda_1^T + \lambda_2^T) C) / a - z_2 \text{sign}((\lambda_1^T + \lambda_2^T) C) / a) d\tau ,
\end{aligned}$$

In (115), terms  $x_1(t)/a$  and  $z_2 x_2(t)/a$  can be recognized. Thus (115) equates

$$x(t) = x_e(t)/a + ER ,$$

$$\begin{aligned}
ER = \int_t^{t_f} \exp(A(t-\tau)) [ & B (\text{sign}((\lambda_1^T + \lambda_2^T) B) - \text{sign}(\lambda_1^T B) / a \\
& - z_2 \text{sign}(\lambda_2^T B) / a) - C (1 - (1 \\
& - (1 + z_2) / a) \text{sign}((\lambda_1^T + \lambda_2^T) C) ] d\tau .
\end{aligned} \tag{116}$$

Now, (116) is an important result, from which the procedure is derived. ER, in particular must be carefully studied: similar terms subtract from each other and the result, a switching function, is integrated against the exponential matrix. Thus, a small value of ER is likely, especially when the number of switches is important.

In the sequel, ER will be assumed to be negligible compared to  $x_e(t)/a$ , thus, an estimate on the upper bound of ER is of interest. Such a bound can easily be obtained by squaring ER and using Schwartz's inequality. Unfortunately, such an inequality has the drawback of

totally suppressing the compensations in ER, resulting in a very bad upper bound.

Since (116) holds at any time, it holds for both  $t = t_0$  and  $t = t_f$  where ER equals zero, thereby verifying hypothesis (113).

As a conclusion, the approximated method performs the composition from the 2-vs.-1 game, therefore requiring the estimation of  $z_2$  and then, according to (116) the initial position of the equivalent pursuer is  $x(t_0) = x_e(t_0)/a$ . Then, the 1-vs.-1 game is solved,  $v^*$  the optimal control of the evader and  $t_f$  the terminal time, are computed. As a last step, the control problem of finding the trajectories and controls of the two pursuers, knowing  $v^*$  and  $t_f$  is solved.

The estimation of  $z_2$  is the most delicate problem in the method; the information available consists of the 1-vs.-1 games. The estimate of the strategic variable will take full advantage of the whole prior information of the game: the 1-vs.-1 Nash and Pareto (i.e., cooperative) game solutions, the study of the game of kind and, particularly, the computation of the help zones.

Let  $t_1$  and  $t_2$  be the terminal times of the individual 1-vs.-1 ( $P_1, E$ ) and ( $P_2, E$ ) games. Let  $t_{1m}$  and  $t_{1M}$  be two limits such that, because of the very position of  $P_2$ , cooperation is possible with  $P_1$  only if  $t_{1m} \leq t_1 \leq t_{1M}$ . Then, if  $t_1 \leq t_{1m}$ ,  $z_2 = 0$  ( $P_1$  is so close to E, that  $P_2$  is useless) and if  $t_1 \geq t_{1M}$ ,  $z_2 = \rightarrow \infty$  ( $P_1$  is so far away from E that  $P_2$  does need any such help).

The simplest formula verifying the above requirements is

$$\hat{z}_2 = k(t_1 - t_{1m}) / (t_{1M} - t_1), \quad (117)$$

where  $k$  is a constant.

Using the same approach, if  $t_{2m}$  and  $t_{2M}$  can be found such that cooperation is possible with  $P_2$  only if  $t_{2m} \leq t_2 \leq t_{2M}$ , then

$$\hat{z}_2 = k(t_1 - t_{1m})(t_{2M} - t_2) / (t_{1M} - t_1)(t_2 - t_{2m}), \quad (118)$$

respects the limit conditions, but the problem is to fix  $k$ . When  $t_1 = t_2$ , both pursuers are likely to be equally dangerous to the evader, therefore  $z_2 = 1$  should be enforced. This remark yields the formula that will be used for  $z_2$ . I. e.,

$$\hat{z}_{21} = (t_1 - t_{1m})(t_{1M} - t_2)(t_{2M} - t_2)(t_1 - t_{2m}) / (t_{1M} - t_1)(t_2 - t_{1m})(t_2 - t_{2m})(t_{2M} - t_1) \quad (119)$$

If none of the four limits  $t_{1m}$ ,  $t_{2m}$ ,  $t_{1M}$  and  $t_{2M}$  can be computed, then  $t_{1m} = t_{2m} = 0$  and  $t_{1M} = t_{2M} = \infty$  is assumed, the estimate becomes

$$\hat{z}_{22} = (t_1/t_2)^2, \quad (120)$$

whereas the simplest estimate for  $z_2$  is

$$\hat{z}_{23} = t_1/t_2. \quad (121)$$

The four time limits are computed as follows:

i) When  $t_1 \leq t_{1M}$ , then  $P_2$  does not play any role ( $z_2 = 0$ ). The best case for  $P_2$  is when  $E$  is willing to be caught: the corresponding time is the terminal time of the Pareto ( $P_2, E$ ) game. If  $t_1$  is even smaller than this time, then, for sure,  $P_2$  is useless.

Thus:  $t_{1M}$  is the terminal time of the Pareto  $(P_2, E)$  game.

$t_{2M}$  is the terminal time of the Pareto  $(P_1, E)$  game.

ii) When  $t_1 \geq t_{1M}$ , then  $P_1$  does not play any role, and  $z_2$  becomes infinite. When  $t_1 = t_{1M}$ , then  $P_1$  is located on the limit of the help zone of  $P_2$ , limiting, by definition, the cooperation zone. Thus a possible bound is to take the maximum of the terminal times of the  $(P_1, E)$  games with  $P_1$  located on the help zone. The help zone is usually assymetrical, since, for a given distance  $x_1(t_0)$ , the cooperation is best when the evader is surrounded by the pursuers. Thus, every 1-vs.-1 trajectory intersects with the boundary of the help zone at a very different time, depending on the position of the intersection. Thus,  $t_{1M}$  will be taken as the terminal time on the limit of the help zone, along the trajectory going through  $x_1(t_0)$  (an example will be shown).  $t_{1M} - t_1$  represents the time separating  $x_1(t_0)$  from the help zone. A similar definition is adopted for  $t_{2M}$ .

#### 4. TIME OPTIMAL EXAMPLE

The game studied has the reduced state equations

$$\dot{x}_i = Ax_i + Bu_i + Cv \quad , \quad (122)$$

$$A = \begin{bmatrix} 0 & 1 \\ 2 & -3 \end{bmatrix} , \quad B = \begin{bmatrix} 0 \\ 2 \end{bmatrix} , \quad C = \begin{bmatrix} 0 \\ 1 \end{bmatrix} , \quad |u_i| \leq 1 , \quad |v| \leq 1 ,$$

and capture is achieved whenever

$$\mathbf{x}_i^T(t_f) M \mathbf{x}_i(t_f) \leq r_i^2 \quad (123)$$

with  $M = I$ ,  $r_i = 1$ .

The minimum-time problem with identical pursuers is considered. Applying the necessary conditions of optimality yield the optimal controls, the costate dynamics and the formula for the Lagrange multiplier as

$$\begin{aligned} u_i^* &= -1 \cdot \text{sign}(\lambda_i^T B) \quad , \\ v_i^* &= 1 \cdot \text{sign}(\sum_i \lambda_i^T C) \quad , \\ \dot{\lambda}_i^T &= -\lambda_i^T A \quad , \end{aligned} \quad (124)$$

$$\lambda_i^T(t_f) = 2v_i x_i^T(t_f) M.$$

$$v \geq 0 \rightarrow - \sum_i z_i x_i^T A x_i + \sum_i |z_i x_i^T B| - |\sum_i z_i x_i^T C| = v/2 \quad ,$$

$$v \leq 0 \rightarrow \sum_i z_i x_i^T A x_i + \sum_i |z_i x_i^T B| - |\sum_i z_i x_i^T C| = v/2 \quad .$$

For a fixed  $x_1(t_0)$ , Figure 19 shows the possible locations of  $x_2(t_0)$  according to the amount of cooperation allowed by  $z_2$ .

It is remarkable that the trajectory of  $P_1$  is not at all affected by  $z_2$ . Since this trajectory is fixed, and differs from the equivalent 1-vs.-1 trajectory, the cooperation of  $P_2$  is required, defining a minimum for  $z_2$  equal to 0.38 in this case.

Figure 20 shows that, when  $P_1$  is chosen very close to the equivalent 1-vs.-1 trajectory, then  $P_2(t_0)$  is constrained to a very limited arc, because the requested help is very specific.

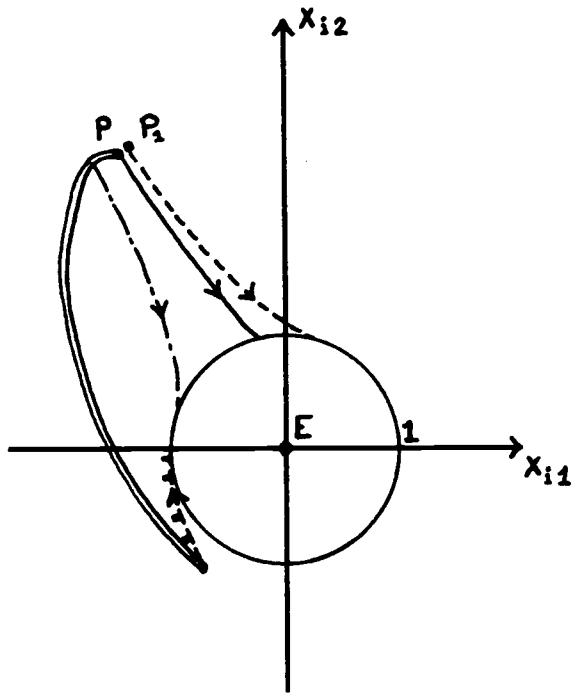

- 1-vs.-1 game.  $x_1(t_f) = -0.27$ .
- >-- 2-vs.-1 game. Trajectory of  $P_1$  for  $x_{11}(t_f) = 0.1$ .
- · · · 2-vs.-1 game. Trajectory of  $P_2$  for  $x_{11}(t_f) = 0.1, z_2 = 0.38$ .
- >- 2-vs.-1 game. Trajectory of  $P_2$  for  $x_{11}(t_f) = 0.1, z_2 = 1$ .
- >- 2-vs.-1 game. Trajectory of  $P_2$  for  $x_{11}(t_f) = 0.1, z_2 = 100$ .
- ==== Location of  $P_2(t_0)$  as a function of  $z_2$ , for  $t_f = 0.5$ .

Figure 19. Time-optimal solution sensitivity to cooperation by  $z_2$ .

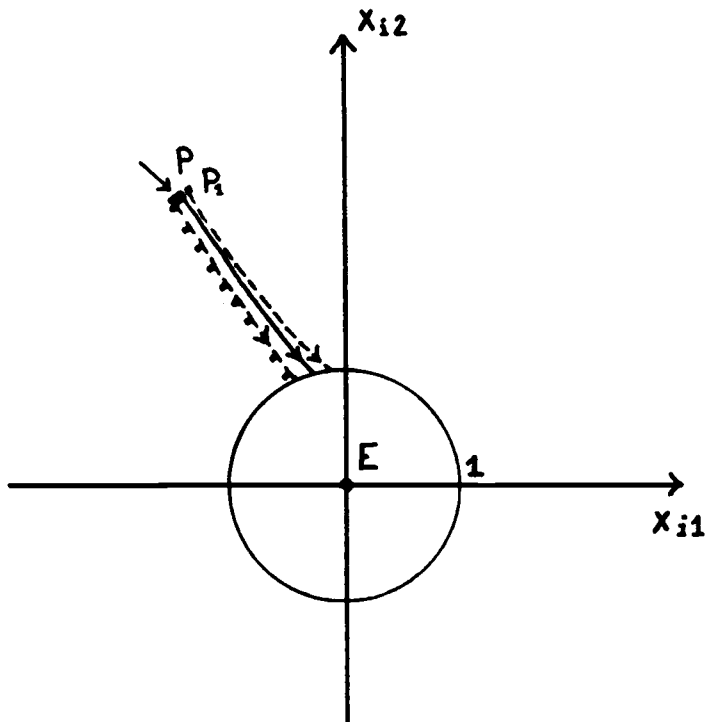

- 1-vs.-1 game.  $x_1(t_f) = -0.27$ .
- 2-vs.-1 game. Trajectory of  $P_1$  for  $x_{11}(t_f) = -0.25$ .
- 2-vs.-1 game. Trajectory of  $P_2$  for  $x_{11}(t_f) = -0.25$ ,  $z_2 = 0.38$ .
- Location of  $P_2(t_0)$  as a function of  $z_2$  for  $t_f = 0.5$ .

Figure 20. Sensitivity relative to second pursuer close to 1-vs.-1 game.



The solution to the 1-vs.-1 game is given in Figure 21. The area in which capture can be avoided is very small. This is due to the stable eigenvector of the matrix  $A$  added to the advantage in control of the pursuer with respect to the evader, illustrated by the matrices  $B$  and  $C$ . The lines of constant terminal time tend to be disformed along the unstable eigenvector  $x_{i2} = (-3-\sqrt{17})x_{i1}/2$ , more favorable to the escape.

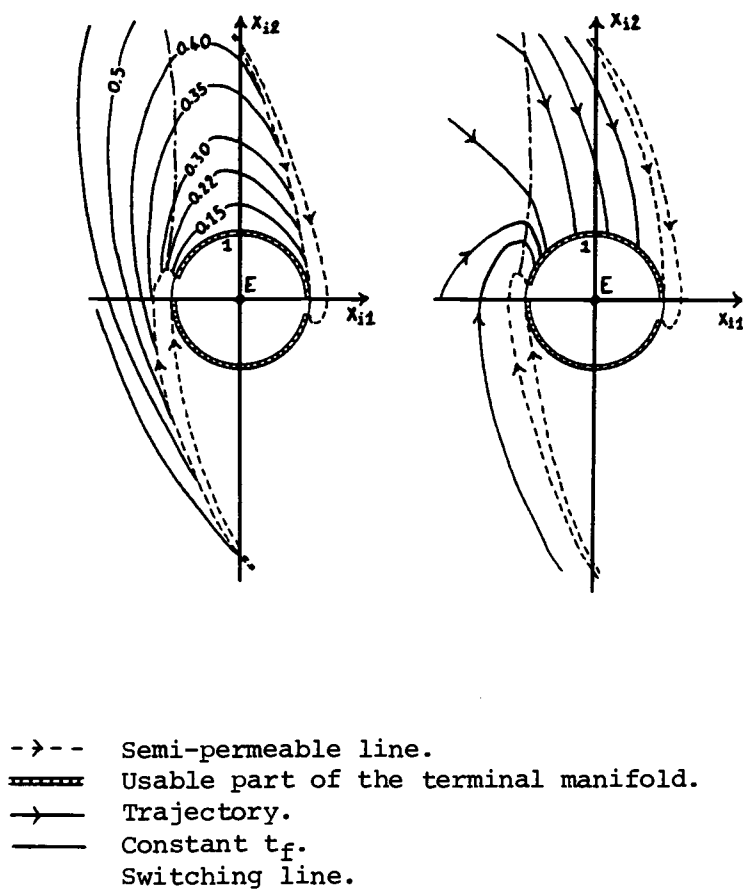
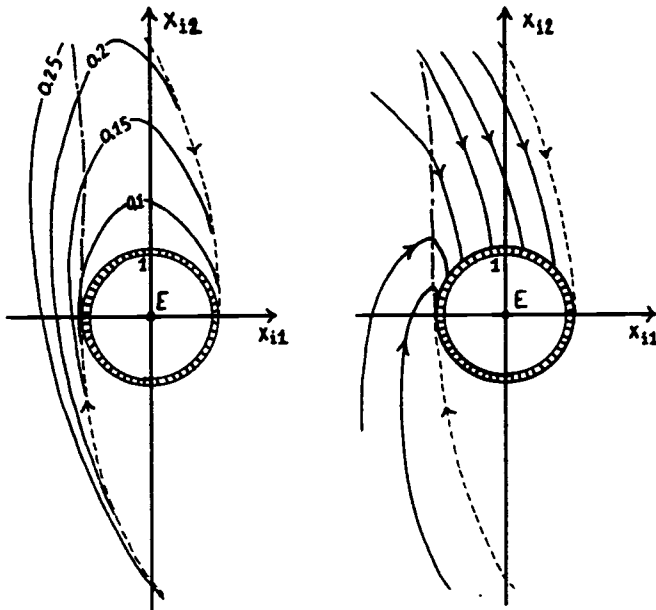

Figure 21. Time-optimal solution for 1-vs.1 game.

The game is symmetrical, the trajectories and the constant terminal time lines are plotted only over half of the space.

The solution to the cooperative (Pareto) game is given in Figure 22.



- >--- Semi-permeable line.
- ▨ Usable part of the terminal manifold.
- Trajectory.
- Constant  $t_f$ .
- Switching line.

Figure 22. Time-optimal solution for 1-vs-1 Pareto game.

The lines of constant terminal time are wider apart and there is no place where capture is impossible; this is expected since, in the Pareto game, E collaborates with P.

The computations for three cases are summarized in Table 1. Cases 1 and 3 correspond to a low and a high value of  $z_2$ , quantifying the cooperation. Case 2 corresponds to the worst possible case, both  $z_2 = 1$  and  $a = 0$  force a bad result. But the expected failure of the method in that case is not a problem since it can be computed that  $v^* = 0$ , this corresponds to a case of maximum advantage of the pursuit team, and this case is treated in Chapter VII.

The controls corresponding to the three cases are plotted in Figure 23. In Case 1, the equivalent pursuer has the same control as  $P_2$ ; in case 3, the same as  $P_1$ , when case 2 corresponds to an equal threat from both pursuers. Of course, both  $v^*$  and  $t_f$  are identical since it is the goal of the procedure to estimate those variables.  $P_1$  and  $P_2$ , trying to collaborate as much as possible, adopt opposite controls, so that E, playing a control opposing one of the pursuers, then plays in favor of the second pursuer.

The three different estimates of  $z_2$  are given in Table 3.  $\hat{z}_{21}$  gives excellent results in cases 1 and 3, but fails in case 2, where  $\hat{z}_{23}$  is superior.  $\hat{z}_{22}$  corresponds to  $\hat{z}_{21}$  when the various limiting times are not available. The results are centered around  $z_2 = 1$ ; in case of uncertainty, the best estimate is a rather equal cooperation between the pursuers.

Figure 24 shows, as an example, how  $t_{1M}$  is computed for case 1.

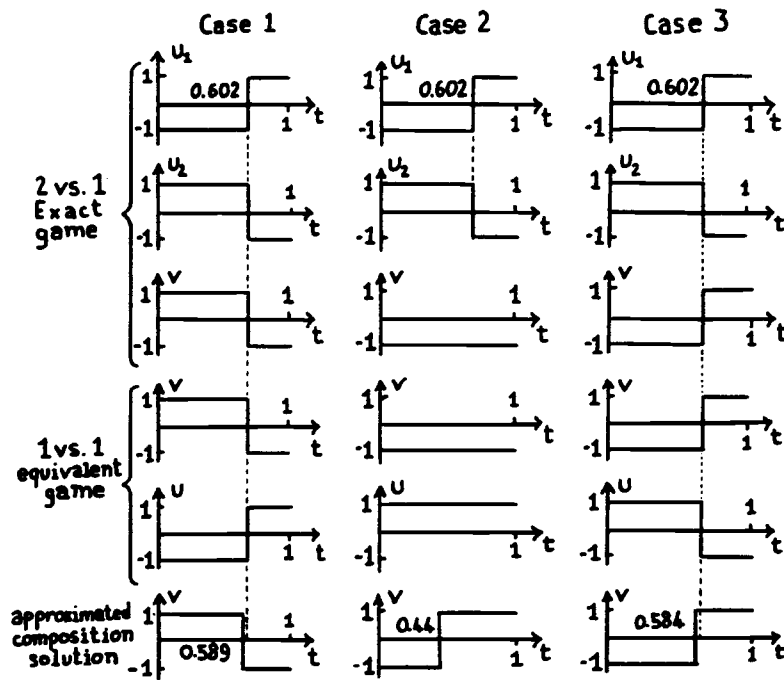

Figure 23. Time-optimal control approximations for Table 1.

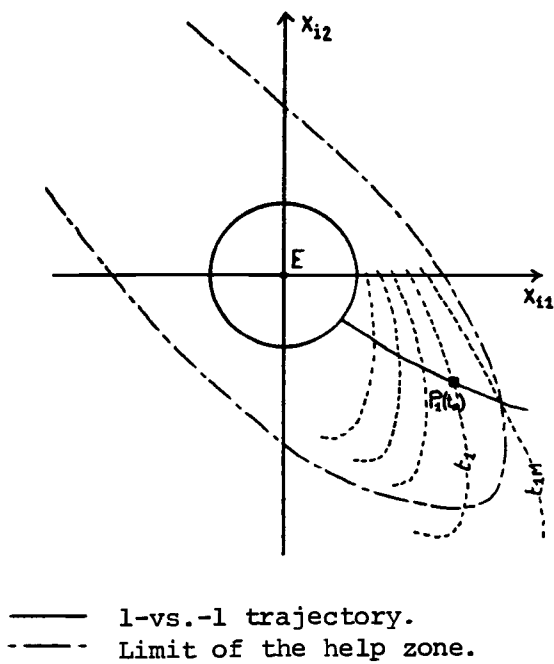

Figure 24. Computation of cooperation-time limit.

Table 3. Time-optimal approximate solution comparisons for three different degrees of cooperation.

		Case 1	Case 2	Case 3
Examples	$P_1(t_0)$	(-5.36, 13.0)	(-7.67, 19.2)	(-7.79, 19.4)
	$P_2(t_0)$	(7.78, -19.4)	(5.47, -12.5)	(5.35, -13.0)
2-vs.-1 exact solution	$P_1(t_f)$	(-0.2, 0.98)	(-0.20, 0.98)	(-0.20, 0.98)
	$P_2(t_f)$	(0.2, -0.98)	(0.20, -0.98)	(0.20, -0.98)
	$z_2$	0.2	1.	5.
	$t_f$	1.00	1.00	1.00
Exact composition	$P(t_0)$	(-5.38, 13.08)	(4.27, -16.16)	(5.38, -13.08)
	$P(t_f)$	(-0.20, 0.98)	(-0.98, -0.20)	(0.20, -0.98)
Estimating $z_2$	$t_1$	1.0025	1.100	1.1075
	$t_2$	1.1075	1.0425	1.0025
	$t_{1m}$	0.860	0.780	0.7525
	$t_{2m}$	0.7525	0.850	0.860
	$t_{1M}$	1.40	1.27	1.32
	$t_{2M}$	1.32	1.40	1.40
	$\hat{z}_{21}$	0.199	1.85	5.007
	$\hat{z}_{23}$	0.905	1.05	1.105
	$\hat{z}_{22}$	0.819	1.103	1.22
	Estimated	$\ x_e\ _{t_f} = a$	0.787	0.943
Exact	$\ x_e\ _{t_f} = a$	0.8	0.	4.
Approximated composition:	$P(t_0)$	(-4.81, 11.61)	(2.618, -4.412)	(4.71, -11.34)
Switch in v:	$t_v$	0.589	0.44	0.584
Exact switch:	$t_v$	0.602	--	0.602

## VII. A CONTROLLABILITY STUDY FOR LINEAR QUADRATIC TEAM GAMES

### 1. INTRODUCTION

The fixed terminal time aspect of the linear, quadratic team games is studied in this chapter. A controllability study of the 1-vs.-1 version of the problem was made by Behn and Ho [26]. These results are adapted to suit the N-vs.-1 team game under study, and the controllability of the team is used as a measure of the efficiency of the individual pursuers, providing a sufficient condition for a pursuer to be useful to a team.

The evader is shown to be neutralized by the maximum controllability strategies. In cases where these strategies are game-optimal, it yields a simple method of solving the difficult problem of optimal disposition of a team of pursuers by providing a choice of optimal conditions to simplify the search for the optimal solution.

### 2. FORMULATION OF THE GAME

The state of pursuer  $P_i$ , controlling  $u_i$ , is defined by the linear dynamic system

$$\dot{x}_i = F_i(t)x_i + \bar{G}_i(t)u_i(t) , \quad (125)$$

$$x_i(t_0) = x_{i0} .$$

The state of the evader, controlling  $v$ , takes a similar form:

$$\dot{x}_e = F_e(t)x_e + \bar{G}_e(t)v(t) \quad , \quad (126)$$

$$x_e(t_0) = x_{e0} \quad -$$

where  $i = 1, 2, \dots, N$ ;  $x_i, x_e \in \mathbb{R}^n$ ,  $u_i \in \mathbb{R}^m$ ,  $v \in \mathbb{R}^p$ , and  $F_i(t)$ ,  $\bar{G}_i(t)$ ,  $F_e(t)$ ,  $\bar{G}_e(t)$  are matrices of appropriate dimensions.

The performance index is given in terms of a miss distance at the fixed terminal time  $t_f$  and an energy integral component as

$$J = \frac{1}{2} a^2 \sum_i \left\| x_i(t_f) - x_e(t_f) \right\|_{A^T A}^2 + \frac{1}{2} \int_{t_0}^{t_f} \sum_i \left\| u_i(t) \right\|_{R_i}^2 - \left\| v(t) \right\|_{R_e}^2 dt \quad , \quad (127)$$

where  $A^T A$  selects the relevant components of the state;  $R_i$ ,  $R_e$  are appropriate positive-definite matrices, and  $a$  is a weighting factor such that, if  $a^2 \rightarrow \infty$ , the problem is to capture the evader with minimum energy. Here  $a^2 \rightarrow \infty$  is used in the sense  $\frac{1}{2} a^2 \sum_i \left\| x_i(t_f) - x_e(t_f) \right\|_{A^T A}^2 = 0$  if  $\sum_i \left\| x_i(t_f) - x_e(t_f) \right\|_{A^T A}^2 = 0$  and  $\infty$  otherwise. Such a performance index, including a summation of the pursuer's achievements does not favor as much cooperation between teammates as a performance involving a minimum operator on the miss distances would, as discussed in Chapter VIII.

A reduced state vector is defined, for each pursuer, as

$$y_i(t) = A \left[ \Phi_i(t_f, t)x_i - \Phi_e(t_f, t)x_e(t) \right] \quad , \quad (128)$$

$$i = 1, 2, \dots, N \quad ,$$

where  $\Phi_i$  and  $\Phi_e$  are the state transition matrices corresponding to (125) and (126).  $y_i(t)$  is the terminal miss  $A(x_i(t_f) - x_e(t_f))$  predicted at time  $t$ , on the basis that no control will be applied during the interval  $[t, t_f]$ . Consequently, a new set of state differential equations is defined by

$$\begin{aligned} \dot{y}_i(t) &= G_i(t_f, t)u_i(t) - G_e(t_f, t)v(t) \quad , \\ y_i(t_0) &= y_{i0} \quad , \quad i = 1, 2, \dots, N \quad , \end{aligned} \quad (129)$$

where  $G_i$  and  $G$  are time-varying matrices satisfying

$$\begin{aligned} G_i(t_f, t) &= A\Phi_i(t_f, t)\bar{G}_i(t) \quad , \\ G_e(t_f, t) &= A\Phi_e(t_f, t)\bar{G}_e(t) \quad , \end{aligned} \quad (130)$$

and the performance index is restated as

$$\begin{aligned} J &= \frac{1}{2} a^2 \sum_i ||y_i(t_f)||^2 + \frac{1}{2} \int_{t_0}^{t_f} (\sum_i ||u_i(t)||_{R_i}^2 \\ &\quad - ||v(t)||_{R_e}^2) dt \quad . \end{aligned} \quad (131)$$

Then, applying the classical calculus of variations, and without lumping the controls of the pursuers into a single control vector, the open-loop optimal controls can be shown to be

$$\begin{aligned} u_i^*(t) &= - a^2 R_i^{-1}(t) G_i^T(t_f, t) y_i(t_f) \quad , \\ v^*(t) &= - a^2 R_e^{-1}(t) G_e^T(t_f, t) (\sum_i y_i(t_f)) \quad . \end{aligned} \quad (132)$$



The optimal controls are a function of the terminal misses, multiplied by a gain which varies according to a position estimate. The form of the control of the pursuers is irrelevant to the number of the teammates, enhancing the relative independence of each pursuer; on the other hand, the evader must compound the various threats represented by the pursuers.

To derive the feedback solutions, two approaches are possible. The first one defines the controls, for  $a = 1$ , as

$$\begin{aligned} u_i^* &= -R_i^{-1} G_i^T K_i^{-1} y_i, \\ v^* &= -R_e^{-1} G_e^T (\sum_i K_i^{-1} y_i), \end{aligned} \quad (133)$$

where matrix  $K_i$  obeys

$$\begin{aligned} \dot{K}_i(t_f, t) K_i^{-1}(t_f, t) y_i(t) &= -G_i(t_f, t) R_i^{-1}(t) G_i^T(t_f, t) K_i^{-1}(t_f, t) y_i(t) \\ &+ G_e(t_f, t) R_e^{-1}(t) G_e^T(t_f, t) \sum_j (K_j^{-1}(t_f, t) y_j(t)), \end{aligned} \quad (134)$$

$$K_i(t_f, t_f) = I.$$

$I$  is the identity matrix. (134) can immediately be simplified for a two-player game,  $i = j = 1$ , but for the team game under study, simplification of (134) requires the introduction of a strategic matrix  $Z_i(t)$  according to Chapter V, defined as a symmetric, non-singular matrix which satisfies

$$K_i^{-1}(t_f, t) y_i(t) = Z_i(t) K_1^{-1}(t_f, t) y_1(t). \quad (135)$$

Then the propagation of  $K_i$  simplifies into

$$\begin{aligned} \dot{K}_i(t_f, t) = & -G_i(t_f, t)R_i^{-1}(t)G_i^T(t_f, t) \\ & + G_e(t_f, t)R_e^{-1}(t)G_e^T(t_f, t)(\sum_j Z_j(t))Z_i^{-1}(t) \end{aligned} \quad (136)$$

By differentiation of (135),  $\dot{Z}_i(t)$  can be shown to be null—a direct consequence of the reduction chosen in (128). Then  $Z_i(t)$  is a constant matrix, which might be a bit surprising, but is true only for the game-optimal strategies.

This approach to the solution is used by Behn and Ho [26] for the simpler two-player case; its advantage is to lend itself to nice controllability interpretations. The major drawback is the inversion of  $K_i$  required to compute the controls. A better computational form was adopted in Chapter V, where

$$\begin{aligned} u_i^* &= -R_i^{-1}G_i^T T_i y_i, \\ v^* &= -R_e^{-1}G_e^T (\sum_i T_i y_i) \end{aligned} \quad (137)$$

and  $T_i$  propagates according to Riccati equations that are readily simplified, using the same strategic matrix approach, into

$$\begin{aligned} \dot{T}_i(t) = & T_i(t) [G_i(t_f, t)R_i^{-1}(t)G_i^T(t_f, t) \\ & - G_e(t_f, t)R_e^{-1}(t)G_e^T(t_f, t)(\sum_j Z_j(t))Z_i^{-1}(t)]T_i(t) \\ T_i(t_f) = & a^2 I \end{aligned} \quad (138)$$

This form is computationally superior, and a strict derivation of the simpler two-player, linear, quadratic games of this kind can be found in Ichikawa [24].

Using  $Z_i$ , the optimal control of the evader can be restated as

$$v^*(t) = -a^2 R_e^{-1}(t) G_e^T(t_f, t) (\sum_i Z_i(t)) K_1(t_f, t) y_1(t). \quad (139)$$

The computation of the optimal controls requires that the  $N$  matrices  $K_i$  be inverted. According to Ho, Bryson and Baron [27], the non-singularity of  $K_i$  is equivalent to the non-existence of a conjugate point, in the one-vs.-one case. Existence of  $K_i^{-1}$  is studied in terms of the team controllability.

### 3. CONTROLLABILITY STUDY OF THE TEAM DIFFERENTIAL GAME

From (136), the  $N$  matrices  $K_i$  are integrated, from the terminal time, as

$$K_i(t_f, t) = I/a^2 + \int_t^{t_f} G_i(t_f, \tau) R_i^{-1}(\tau) G_i^T(t_f, \tau) d\tau \\ - \sum_j \int_t^{t_f} G_e(t_f, \tau) R_e^{-1}(\tau) G_e^T(t_f, \tau) Z_j(\tau) Z_i^{-1}(\tau) d\tau. \quad (140)$$

Matrices  $Z_i(t)$  being constant, a more compact notation is

$$K_i(t_f, t) = I/a^2 + M_{ri}(t_f, t) - M_e(t_f, t) (\sum_{j \neq i} Z_j) Z_i^{-1}, \quad (141)$$

where

$$\begin{aligned}
 M_{ri}(t_f, t) &= M_i(t_f, t) - M_e(t_f, t) \quad , \\
 M_i(t_f, t) &= \int_t^{t_f} G_i(t_f, \tau) R_i^{-1}(\tau) G_i^T(t_f, \tau) d\tau \quad , \\
 M_e(t_f, t) &= \int_t^{t_f} G_e(t_f, \tau) R_e^{-1}(\tau) G_e^T(t_f, \tau) d\tau \quad .
 \end{aligned}
 \tag{142}$$

From [26],  $M_i$  and  $M_e$  are the reduced controllability grammians of the pursuer and of the evader, and, for the 1-vs.-1 game, where  $P_i$  faces  $E$ ,  $M_{ri}$  is called the relative controllability grammian of pursuer  $P_i$ . It expresses the control superiority of pursuer  $P_i$  over the evader, in the 1-vs.-1 game.

A sufficient condition to ensure existence of matrices  $K_i^{-1}$  is the semi-positive definiteness of the  $N$  matrices

$$M_{ri}(t_f, t) - M_e(t_f, t) \left( \sum_{j \neq i} z_j \right) z_i^{-1} \geq 0 \quad ,
 \tag{143}$$

where, for the 1-vs.-1 case, a sufficient condition is

$$M_{ri}(t_f, t) \geq 0 \quad .
 \tag{144}$$

If all the pursuers are playing a "positive" role in the game, pursuer  $P_i$  must be better off as a team member than playing alone.

Therefore a sufficient condition for pursuer  $P_i$  to be efficient is that

$$- M_e(t_f, t) \left( \sum_{j \neq i} z_j \right) z_i^{-1} \geq 0 \quad ,
 \tag{145}$$

holds. Since  $M_e$  is positive definite, another sufficient condition is

$$\left( \sum_{j \neq i} z_j \right) z_i^{-1} \leq 0 \quad .
 \tag{146}$$

Both conditions provide criteria to select the relevant pursuers to form a team.

(143) can also be expressed as

$$M_i(t_f, t) - M_e(t_f, t) (\sum_j Z_j) Z_i^{-1} \geq 0 \quad . \quad (147)$$

Then a possible strategy for  $P_i$ , to which corresponds a strategic matrix  $Z_i$ , is to try and maximize (147), in order to be as "efficient" as possible. This strategy is named the maximum controllability strategy since it is related to the relative controllability grammians. If all the pursuers play a maximum controllability strategy, then the sum of the terms as (147), i.e.

$$\sum_{i=1}^N ((M_i(t_f, t) - M_e(t_f, t) (\sum_j Z_j) Z_i^{-1})) Z_i^2 \quad , \quad (148)$$

is also maximized, since  $Z_i^2$  is a non-singular, positive-definite matrix. (148) can be reorganized as

$$\sum_i M_i(t_f, t) Z_i^2 - M_e(t_f, t) (\sum_j Z_j) (\sum_i Z_i) \quad . \quad (149)$$

(149) is named the team controllability grammian. Due to the symmetry of the strategic matrices, the product

$$(\sum_j Z_j) (\sum_i Z_i) = (\sum_i Z_i)^2 \quad , \quad (150)$$

is positive definite, and so are  $M_i$ ,  $M_e$  and  $Z_i^2$ . Then, in order to play a maximum controllability strategy, (150) must be maximized and  $(\sum_i Z_i) = 0$  must hold or, for all  $i = 1, \dots, N$ , the pursuers must play a strategy such that

$$Z_i = - \sum_{j \neq i} Z_j \quad , \quad (151)$$

From (151) and (139), the optimal control of the evader corresponding to the maximum controllability strategy of the team, is identically null. If the game is to be played, the best strategy of the evader is to do...nothing! The evader is denied any incentive to move and is said to be neutralized by this (possibly non-game optimal) strategy played by the team.

#### 4. MOST CONTROLLABLE DISPOSITION OF PURSUIT TEAM

The most controllable disposition of a pursuit team is such that the maximum controllability strategy is also the game-optimal strategy for the team of pursuers. And, as shown, the evader is neutralized by that disposition. Then the team is said to be optimal.

If the matrices defined in (145) are positive definite, then multiplying each end by the vector  $K_i^{-1}(t_f, t)y_i(t)$  and using definition (135), yields the scalar inequality

$$-y_i^T(t)K_i^{-T}(t_f, t)M_e(t_f, t) \sum_{j \neq i} K_j^{-1}(t_f, t)y_j(t) \geq 0, \quad (152)$$

and, as  $t \rightarrow t_f$ ,  $M_e(t_f, t)$  is proportional to

$$C(t_f) = A\bar{G}_e(t_f)R_e^{-1}(t_f)\bar{G}_e^T(t_f)A^T. \quad (153)$$

Then, since  $K_j(t_f, t) = I/a^2$  at  $t = t_f$ , (153) becomes

$$\alpha y_i^T(t_f)C(t_f) \sum_{j \neq i} y_j(t_f) \leq 0, \quad (154)$$

where  $\alpha$  is a positive constant.

In order for pursuer  $P_i$  to play a maximum controllability strategy, and for a given miss distance,  $y_i(t_f)$  must minimize the

vector product (154); it expresses the fact that an efficient teammate  $P_i$  must, at the terminal time, face the vectorial sum of the miss vectors of the remaining pursuers, modified by the constant matrix  $C(t_f)$ , expressing the evader's interest and capabilities, to cut the evader's main exit direction.

If a pursuer  $P_i$  is to be joined to the team  $(P_j)$ ,  $i \neq j$ , to provide a maximum controllability strategy over the evader, then (154) must be minimized. Or, in order for a team of pursuers to be optimal facing an evader, then the set of equations (154) must be jointly minimized. (154) provides  $N - 1$  independent terminal time equations for  $N$  pursuers, greatly simplifying the formidable task of finding the optimal controls of this  $(N + 1)$  point, boundary-value problem.

One important consequence for two-identical pursuer games is that (151) becomes  $Z_1 = -Z_2 = I$ , because of the very definition of the strategic matrices (135). Then, for a fixed  $x_1(t_0)$ ,  $x_2(t_f)$  is chosen as to minimize (154). The trajectories corresponding to the two-player game  $(P_1, E)$  and the trajectory of  $P_1$  in the three-player game  $(P_1, P_2, E)$  must match at  $t = t_0$ . Due to the symmetry of the differential game, to locate "optimally"  $P_2$  as to obtain the most controllable of the pursuit team, the two-pursuer game does not need to be studied at all i.e., the one-pursuer game  $(P_2, E)$  equations are merely integrated backwards in time from the terminal state  $y_2(t_f)$  given by (154), to find, at  $t = t_0$ , the position of  $P_2$  which is optimal.

The above procedure applies, in fact, whenever  $N-1$  pursuers are already located, then the study of the  $(N-1)$ -pursuer game gives the solution. Then the trajectories and controls of the  $N$ -pursuer game are computed from a simple one-sided, control problem, since the game-optimal strategy is a maximum controllability strategy for the optimal team, and, as shown, it implies that the evader is neutralized, i.e.,  $v^* = 0$  and  $N-1$  independent terminal-time relations minimizing (154) are known to hold.

### 5. EXAMPLE

A second-order, two-pursuer game is studied, in which both pursuers are identical, with  $A = I$ ,  $R_e = R_i = I$ ,  $\bar{G}_i = I$ ,  $\bar{G}_e = \frac{1}{2} I$ ,  $t_f = 0.75$  and

$$F_i = F_e = \begin{pmatrix} -0.1 & 0.1 \\ 0.1 & -0.2 \end{pmatrix} . \quad (155)$$

Figure 25 shows the real trajectories, with  $x_e(t_0) = (0, 0)$ . The line is traced which corresponds to every possible position  $x_2(t_0)$  for a fixed  $x_1(t_0)$  and such that the terminal optimal condition (154) is minimized. This line of perfect help passes exactly through the point  $-x_1(t_0)$ , as expected. This line is limited because the miss distances of  $P_1$  and  $P_2$  must be positive. Considering  $x_2(t_0)$  as a parameter, the line of perfect help can be thought of as separating the area in which  $P_2$  strives to decrease the terminal miss from the area in which  $t_f$  is large enough to allow  $P_2$  to primarily think of reducing its energy spending.



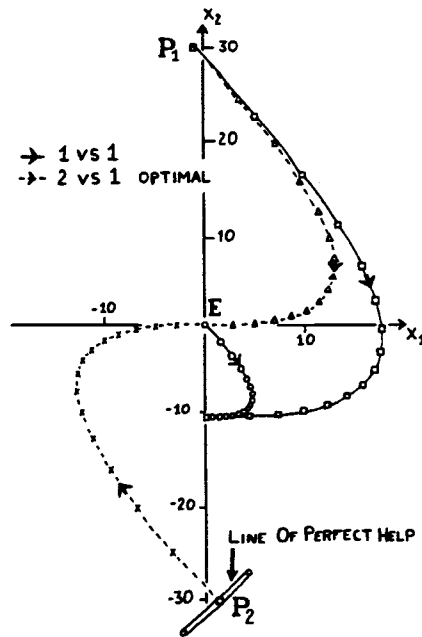

Figure 25. Most controllable two-pursuer team.

A more painstaking study, to compute the lines of constant terminal payoff, is required to use the 1-vs.-1 trajectory to locate optimally pursuer  $P_2$ , constrained to a zone at  $t = t_0$ , in order to minimize the terminal payoff. This task is more feasible concerning minimum time problems.

## VIII. STRUCTURAL CHOICES OF A STOCHASTIC DIFFERENTIAL TEAM GAME

### 1. INTRODUCTION

Stochastic differential games in which both parties make noisy measurements of the state have a closure problem due to the fact that an optimal control should take advantage of the estimate of the error made by the opponent in its own estimate, but this estimate, in turn, is not exact and must be estimated by the former player, etc.

On the other hand, games in which only one party makes perfect measurements do not have such problems. Moreover, the separation principle, dividing the stochastic game into an estimation problem followed by a game analysis, can easily be studied. In the problem studied below, the evader makes perfect measurements.

The team stochastic differential game arises between two sonars (or radar) systems and a target. The target uses a mixed strategy by adding white noise into its controller to hamper the tracking of the sonars. The study, relying on the classical calculus of variations, provides insight into the solutions of difficult problems specific to team games. In particular, various cooperative modes between the two sonar systems are shown to produce different results. The game is studied according to a centralized or a decentralized organization which are equivalent for passive targets that do not use their white noise control capabilities. Conditions are derived under which the Nash-optimal choices of a structure are demonstrated.

To illustrate further team-game problems, a non-optimal, generated, scalar case is presented in which the decentralized structure is proven superior, and where singularities are studied. Due to the open-loop nature of the problem, a Stackelberg (hierarchical) game can be defined in the same context.

## 2. GAME STATEMENT

Two ships, equipped with sonar (or radar) systems are tracking a target whose dynamics are assumed to have the linear form

$$\dot{x} = F(t)x + G(t)v, \quad (156)$$

where  $F(t)$  and  $G(t)$  are known matrices of dimension  $n \times n$  and  $n \times p$ ;  $x$  is an  $n$ -vector of state variables, and  $v$  is a  $p$ -control vector.

The action of the ships as a team is not the a posteriori result of a coalition dictated by a common interest but an a priori assumption whereby the overall performance of the team supersedes the individual payoffs.

The target, detected at time  $t_0$ , is tracked up to time  $t_f$ . In the mean time, it uses its control capabilities to achieve both good accuracy in reaching its destination and a maximum in the tracking error estimate made by the ships.

Ho [28] suggests a control law of the form  $u = K(t)x + \zeta$ .  $K(t)$  is a  $p \times n$  feedback matrix and  $\zeta$  a  $p$ -vector of Gaussian white noise components with statistical parameters  $E(\zeta(t)) = 0$  and  $E(\zeta(t)\zeta(\tau)) = T(t)\delta(t-\tau)$ , where  $T(t)$  is a  $p \times p$  matrix used by the target as a control variable. Through the control of the statistical

parameters in the matrix  $T$ , the target is able to play a mixed strategy to complicate the estimation algorithm of the tracking team, but at the expense of self-inflicted perturbations.

The ships simultaneously, but on an independent basis, record continuous noisy measurements of the state  $x$  of the target, in the following form:

$$z_i = H_i(t)x + s_i, \quad i = 1, 2. \quad (157)$$

$H_i$  is a known  $q \times n$  matrix, and  $s_i$  is a  $q$ -vector containing Gaussian white noise components such that  $E(s_i) = 0$  and  $E(s_i(t)s_i^T(\tau)) = S_i(t)\delta(t-\tau)$  where  $S_i(t)$  is given. For convenience,  $s_1$  and  $s_2$  are assumed to be statistically independent, i.e.,  $S_{12} = E(s_1(t)s_2^T(\tau)) = 0$ .

From these two measurements, and knowing the target dynamics (156), the tracking team is able to design a (Kalman) filter by optimizing its gain according to the performance index. If  $T(t)$  were known by the team, then  $\zeta$  could be treated as a mere corrupting noise of given characteristics, to be averaged out by the filter. Unfortunately, the actual characteristics of the corrupting noise  $\zeta$  are unknown to the pursuers since it is controlled by the target. At this point, two approaches are possible. The brute-force method assumes in (156) a value  $T_{\max}$  of maximum corrupting-noise covariance, covering the worst possible case, and performs the state estimation on that basis. This method has the obvious advantage of great simplicity but might be overwhelmingly penalizing if the target decides not to use a mixed control at all.

Consequently, the second method, namely the gaming approach, is considered here. The overall problem might be decomposed into two

steps: first, the game is solved by the tracking team which computes the game-optimal controls played by the target. Then, on line, when the target is actually detected, the tracking is performed according to these assumptions. Of course, the actual target might not adopt the controls predicted by the game analysis, but the tracking team is guaranteed a minimum payoff by playing according to the game-optimal controls. The same type of approach is used by the target to predict the optimal filter gains on which to base its optimal control strategy.

A remark of importance is that neither the tracking team, nor the target is able to compute the exact performance. Actually, the error estimate covariance computed on line by the tracking team corresponds to the truth only in the physically improbable event of an optimal play made by both parties. Throughout, it will be assumed that a referee has access to both sides to compute the real performance.

Therefore, the problem as introduced is a game and not a classical estimation problem. In the sequel, the optimality of the filters does not refer to the control actually played by the target but the filters are to be understood as game-optimal filters.

Team game analysis, as opposed to the 1-vs.-1 game problem, such as studied by Speyer [23] is the main objective. In particular, the various communication structures that define cooperation levels reflected by the very choice of the performance index, together with structural choices that supersede control strategies, are examined.

### 3. COMMUNICATION STRUCTURE

Perfect information is assumed; in particular, the form of the target dynamics and control, the measurement equations, the form of the estimator filters as well as the statistical parameters of the various random variables and the initial states are known by both parties.

Several filtering structures to estimate the state of the target from the measurements are discussed but, throughout, the various filters have the linear form

$$\dot{\bar{x}}_i = (F + GK)\bar{x}_i + L_i(z_i - \bar{z}_i), \quad (158)$$

where  $\bar{z}_i = H_i\bar{x}_i$  and  $L_i$  is the filter gain (control) to be optimized.

The linear form of the equations and the Gaussian assumptions allow a restatement of the game in terms of a differential equation governing the propagation of the covariance of the state variables by

$$\dot{X} = (F + GK)X + X(F + GK)^T + GTG^T, \quad (159)$$

$$X = E(x(t)x^T(\tau)).$$

The target makes perfect measurements of its own state; the separation principle holds, and the stochastic game is reformulated as a deterministic game of perfect information, belonging to the class of problems investigated by Isaacs [3].

Similarly, a linear estimator based on measurements  $z_i = H_i(t)x + s_i$  has an error-covariance matrix propagating as

$$\dot{P}_i = (F+GK-L_i H_i)P + (F+GK-L_i H_i)^T P + L_i S_i L_i^T + GTG^T, \quad (160)$$

$$P_i = E((x - \bar{x}_i)(x - \bar{x}_i)^T).$$

The cooperation levels between the members of the team are related to the density of their communication network. For example, when the two ships are not allowed, or do not possess the ability, to improve their estimate by comparing their results, then the target strives to increase the uncertainty of the best performer according to the performance index

$$J = \text{tr}\{0.5 AA^T X(t_f) - 0.5 \int_{t_0}^{t_f} \min_{1,2}(P_1(t), P_2(t)) dt\}, \quad (161)$$

with  $AA^T$  an  $n \cdot n$  weighting matrix and  $\text{tr}$  the trace operator. Though playing independently, it can be shown that teammates cannot solve the game unless they can compare  $P_1$  with  $P_2$  to compute the target control that is used. The operator "min" can be eliminated by defining an equivalent 3-vs.-1 game, somewhat as suggested by Gourishankar and Salama [30], as shown in Section III.2.

On the other hand, a fairly easy generalization of a result due to Speyer [29] can be derived by defining  $J$  as

$$J = \text{tr}\{0.5 AA^T X(t_f) - 0.5 \int_{t_{0i}}^{t_f} \sum_i P_i(t) dt\}. \quad (162)$$

In that case, it can be shown that no communication is required between teammates; therefore, the structure of the game does not possess feedback links. Though in a simpler form, this performance index is ill defined since, from the target's point of view, a large  $P_1$  does not compensate for a small  $P_2$ .

When a permanent link is established between the pursuers, then cooperation can be total. The tracking team comes up with a unique estimate and associated covariance  $P(t)$  according to the performance index, adopted from now on:

$$J = \text{tr}\{0.5 AA^T X(t_f) - 0.5 \int_{t_0}^{t_f} P(t) dt\} . \quad (163)$$

Computing directly the overall optimal tracking strategy will not be attempted, but rather, structures are defined a priori in order to compare the classical 1-vs.-1 game with the more peculiar team games. Two filtering structures are developed in detail in the next section. In the first one, referred to henceforth as the centralized structure, the two input measurements are merged together using a zero-memory filter to produce a unique early estimate; this is conceptually equivalent to a measurement which is the object of the study. Therefore, the game becomes a 1-vs.-1 game of the classical type, such as studied by Speyer [29].

In the second case, named decentralized structure, each team member optimizes its very own filter gain, producing an estimate which is, in a later stage, combined with that of its copursuer to produce the overall team estimate. This 2-vs.-1 game structure is compared to the previous one.

The estimation counterpart to this game problem, i.e., the brute-force method proposed earlier, is also interesting. Both structures can be compared with the overall optimal linear filter based on the optimization of the gains  $L_1$  and  $L_2$  as



$$\dot{\bar{x}} = (F + GK) \bar{x} + L_1(z_1 - \bar{z}_1) + L_2(z_2 - \bar{z}_2) , \quad (164)$$

$$\bar{z}_i = H_i \bar{x} .$$

On the other hand, the decentralized structure, because of the common information it is based upon, is not to be compared with a decomposition scheme, such as arises when the optimal smoothing solution for linear dynamic systems is derived as the combining of two Kalman filters working on intervals  $(t_o, t)$  and  $(t, t_f)$ , for non overlapping measurement subsets.

#### 4. THE TWO STRUCTURES

##### 4.1 The centralized structure

Figure 26 shows a block-diagram representation of the centralized structure. The two measurements  $z_1$  and  $z_2$  collected from the sonar channels are merged in a zero-memory, linear filter (LF) of the form

$$\bar{z} = z_1 + C(z_2 - z_1) . \quad (165)$$

C is to be computed as to minimize the mean square error:

$$S = E((\bar{z} - z)(\bar{z} - z)^T) , \quad (166)$$

where  $z = Hx$ . For  $H_i = H$ , S can be computed as

$$S = S_1 + S_{12} C^T - S_1 C^T + C S_{12} - C S_1 + C(S_1 + S_2 - 2S_{12}) C^T , \quad (167)$$

or alternatively as

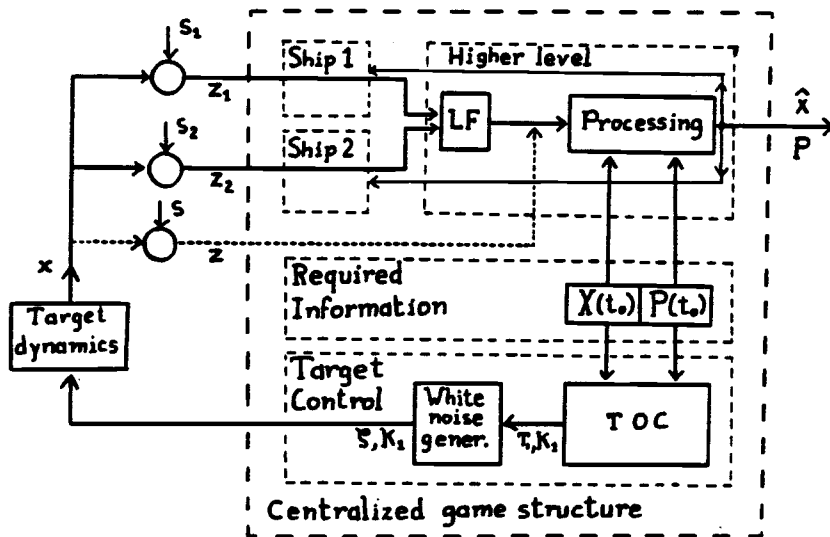

Figure 26. Block diagram of the centralized game structure. TOC is the target optimal controller.

$$S = S_1 - M_1(S_1 - S_{12}) + (C - M_1)(S_1 + S_2 - 2S_{12})(C - M_1)^T, \quad (168)$$

$$M_i = (S_i - S_{12})(S_1 + S_2 - 2S_{12})^{-1}.$$

Now, since  $M_1$  and  $(S_1 + S_2 - 2S_{12})$  are positive definite, (168) is minimized for  $C = M_1$ , and then, using (157), (165) can be expressed as

$$\bar{z} = Hx + (M_1 s_2 + M_2 s_1). \quad (169)$$

An equivalent noise  $s$  is defined as

$$s = M_1 s_2 + M_2 s_1. \quad (170)$$

It can be verified that  $E(s) = 0$  and the covariance of  $s$ , i.e.,  $S = E(s(t)s^T(\tau))$ , is

$$S = S_1(S_1 + S_2)^{-1}S_2, \quad (171)$$

$$\text{or } S^{-1} = S_1^{-1} + S_2^{-1},$$

since  $S_{12} = 0$  is assumed. Thus, the result of the merging of the two measurements is conceptually equivalent to a single measurement vector  $z$ , corrupted by the Gaussian white noise  $s$ . By using the zero-memory linear filter, the problem is reduced to a simple 1-vs.-1 game. Thus 1-vs.-1 game is then solved using calculus of variations. The performance index and the variational Hamiltonian are defined as

$$J(K_1, T_1) = \text{tr}\{X_1(t_f) - 0.5 \int_{t_0}^{t_f} P(t) dt\}, \quad (172)$$

$$\begin{aligned}
H = \text{tr}\{-0.5 P + \Lambda_x ((F+GK_1)X_1 + X_1(F+GK_1)^T + GT_1G^T) \\
+ \Lambda_p ((F+GK_1-LH)P + P(F+GK_1-LH)^T + LSL^T + GT_1G^T)\} .
\end{aligned}
\tag{173}$$

$\Lambda_x$  and  $\Lambda_p$  are the Lagrange-multiplier matrices associated with the covariances  $X$  and  $P$ .  $T_1$  is the target variance control and  $P$  is the estimator error variance.  $K$  is the feedback-control matrix.

The costate variables propagate as

$$\begin{aligned}
\dot{\Lambda}_x &= -\Lambda_x(F+GK_1) - (F+GK_1)^T\Lambda_x , \\
\Lambda_x(t_f) &= I , \\
\dot{\Lambda}_p &= 0.5 I - \Lambda_p(F+GK_1) - (F+GK_1)^T\Lambda_p , \\
\Lambda_p(t_f) &= 0 .
\end{aligned}
\tag{174}$$

The necessary conditions of optimality yield the optimal control gain  $L$  as

$$\frac{\partial H}{\partial L} = (-2HP + 2SL^T) \Lambda_p = 0 ,
\tag{175}$$

and since it can be checked from (174) that  $\Lambda_p$  is non-singular except at  $t = t_f$ , the optimal control  $L$  for this 1-vs.-1 case is

$$L = PH^TS^{-1} .
\tag{176}$$

Substituted back into (160), this yields the familiar Kalman-filter formulation,

$$\dot{P} = (F+GK_1)P + P(F+GK_1)^T - PH^TS^{-1}HP + GT_1G^T ,
\tag{177}$$

optimized according to the given couple  $(K_1, T_1)$ .

The target control  $T_1$  takes values in the interval  $[0, T_{\max}]$ , and the feedback matrix  $K_1$  is bounded by the matrices  $K_{\min}$  and  $K_{\max}$ . The optimal control law  $K_1$  is computed as

$$\frac{\partial H}{\partial K_{lij}} = \{(2X\Lambda_x + 2P\Lambda_p)G\}_{ji} \begin{array}{l} > 0 \rightarrow K_{lij} = K_{ijmin} , \\ < 0 \rightarrow K_{lij} = K_{ijmax} \end{array} \quad (178)$$

and  $T_1$  is

$$\frac{\partial H}{\partial T_{lij}} = \{G^T(\Lambda_x + \Lambda_p)G\}_{ji} \begin{array}{l} > 0 \rightarrow T_{lij} = 0 , \\ < 0 \rightarrow T_{lij} = T_{ijmax} , \end{array} \quad (179)$$

The above generalizes the results obtained in [29] where, for the scalar case, it is proven that no singular arc can occur in (178). However, singularities play a major role for  $T_1$  in the derivation of the solution of the 1-vs.-1 game. This point is illustrated by an example in [29] which is unfortunately in error.

#### 4.2 The decentralized structure

In the 2-vs.-1 team game depicted in Figure 27, each ship computes its own estimate  $\bar{x}_i$  and associated error covariance  $P_i$  which are then combined by the same type of zero memory linear filter as in the previous structure. Each ship is given more processing power but the task of the higher hierarchical level is a lot simpler than for the centralized structure.

The processing algorithms P1 and P2 associated with the ships include the sonar channel, a Kalman filter and a model of the target dynamics. Feedback, under the form of the output covariance  $Q$  is

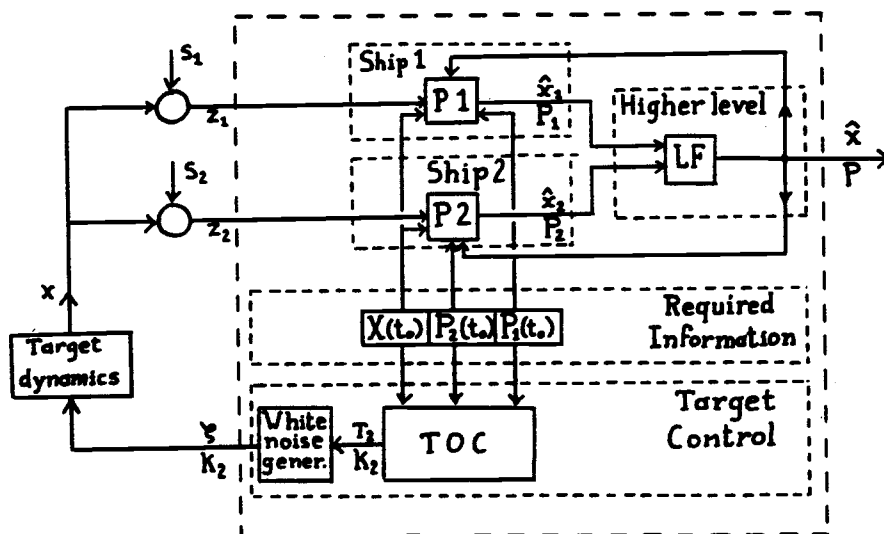

Figure 27. Block diagram of the decentralized game structure.

required by the individual ships to compute their optimal controls. Elaborated information is passed on to the higher level whereas, previously, raw measurements are communicated.

According to section 4.1, the output covariance is

$$Q = P_1 - (P_1 - P_{12}) (P_1 + P_2 - 2P_{12})^{-1} (P_1 - P_{12}) , \quad (180)$$

or 
$$Q = 0.5 (P_1 M_2^T + P_2 M_1^T + P_{12}) , \quad (181)$$

where 
$$M_i = (P_i - P_{12}) (P_1 + P_2 - 2P_{12}) . \quad (182)$$

$P_{12}$  is the cross covariance defined as  $P_{12} = E((x - \bar{x}_1)(x - \bar{x}_2)^T)$  and can be shown to propagate as

$$\dot{P}_{12} = GT_2 G^T , \quad (183)$$

where

$$\begin{aligned} P_{12}(t_0) &= E(x(t_0) - \bar{x}_1(t_0))(x(t_0) - \bar{x}_2(t_0))^T \\ &= E(s_1(t_0)s_2^T(t_0)) = 0 . \end{aligned} \quad (184)$$

Thus, it can be seen that, through the use of the mixed strategy  $T_2$ , the target is able to control directly the amount of cross covariance or redundancy in the computation performed by the teammates.

Then, the game is solved using the calculus of variations approach. The performance index is

$$I(K_2, T_2) = \text{tr}\{X_2(t_f) - 0.5 \int_{t_0}^{t_f} Q(t) dt\} , \quad (185)$$

where  $Q$  is given by (181). The state equations are

$$\begin{aligned}
\dot{X}_2 &= (F+GK_2)X_2 + X_2(F+GK_2)^T + GT_2G^T, \\
\dot{P}_i &= (F+GK_2)P_i + P_i(F+GK_2)^T - L_iH_iP_i - P_iH_i^TL_i^T + L_iS_iL_i^T + GT_2G^T, \\
\dot{P}_{12} &= GT_2G^T.
\end{aligned} \tag{186}$$

The Hamiltonian is

$$\begin{aligned}
H = \text{tr}\{ &-0.5 Q + \Lambda_x ((F+GK_2)X_2 + X_2(F+GK_2)^T + GT_2G^T) + \Lambda_{p12}GT_2G^T \\
&+ \Lambda_{p1} ((F+GK_2)X_2 + X_2(F+GK_2)^T - L_1H_1P_1 - P_1H_1^TL_1^T + L_1S_1L_1^T + GT_2G^T) \\
&+ \Lambda_{p2} ((F+GK_2)X_2 + X_2(F+GK_2)^T - L_2H_2P_2 - P_2H_2^TL_2^T + L_2S_2L_2^T + GT_2G^T) \},
\end{aligned} \tag{187}$$

where the Lagrange matrices  $\Lambda_x$ ,  $\Lambda_{p1}$ ,  $\Lambda_{p2}$  and  $\Lambda_{p12}$  obey

$$\begin{aligned}
\dot{\Lambda}_x &= -\Lambda_x(F+GK_2) - (F+GK_2)^T\Lambda_x; \Lambda_x(t_f) = I, \\
\dot{\Lambda}_{p12} &= -0.5(M_1M_2^T + M_2M_1^T); \Lambda_{p12}(t_f) = 0, \\
\dot{\Lambda}_{p1} &= 0.5(M_1M_1^T + M_2M_1^T + M_1M_2^T) - \Lambda_{p1}(F+GK_2) - (F+GK_2)^T\Lambda_{p1} \\
&\quad + \Lambda_{p1}^T P_1 H_1^T L_1^T + L_1 H_1 P_1 \Lambda_{p1}^T; \Lambda_{p1}(t_f) = 0, \\
\dot{\Lambda}_{p2} &= 0.5(M_2M_2^T + M_2M_1^T + M_1M_2^T) - \Lambda_{p2}(F+GK_2) - (F+GK_2)^T\Lambda_{p2} \\
&\quad + \Lambda_{p2}^T P_2 H_2^T L_2^T + L_2 H_2 P_2 \Lambda_{p2}^T; \Lambda_{p2}(t_f) = 0,
\end{aligned} \tag{188}$$

and

$$M_i = (P_i - P_{12})(P_1 + P_2 - 2P_{12})^{-1}. \tag{182}$$



The necessary conditions of optimality yield the optimal controls

$L_1$  and  $L_2$  as

$$\frac{\partial H}{\partial L_i} = (-2H_i P_i + 2S_i L_i^T) \Lambda_{pi} = 0, \quad (189)$$

or

$$L_i = P_i H_i^T S_i^{-1}. \quad (190)$$

The target controls are given by

$$\frac{\partial H}{\partial K_{2ij}} = \{(2X_2 \Lambda_x + 2P_1 \Lambda_{p1} + 2P_2 \Lambda_{p2}) G\}_{ji} \begin{array}{l} > 0 \rightarrow K_{2ij} = K_{ijmin} \\ < 0 \rightarrow K_{2ij} = K_{ijmax} \end{array} \quad (191)$$

and

$$\frac{\partial H}{\partial T_{2ij}} = \{G^T (\Lambda_x + \Lambda_{p1} + \Lambda_{p2} + \Lambda_{p12}) G\}_{ji} \begin{array}{l} > 0 \rightarrow T_{2ij} = 0, \\ < 0 \rightarrow T_{2ij} = T_{ijmax} \end{array} \quad (192)$$

#### 4.3 Comparison of the structures

In order to make a decision concerning the choice of structure,  $I(K_2, T_2)$  is to be compared with  $J(K_1, T_1)$ . A possible way involves extensive simulation for the very example under study. Here, an analytical method aimed at deriving sufficient conditions is chosen instead. For all  $(K, T)$ , the Nash optimal inequalities,

$$I(K_2, T_2) \leq I(K, T), \quad (193)$$

$$J(K_1, T_1) \leq J(K, T),$$

hold since the target, controlling K and T, is the minimizing player; in particular

$$\begin{aligned} I(K_2, T_2) &\leq I(K_1, T_1) , \\ J(K_1, T_1) &\leq J(K_2, T_2) , \end{aligned} \tag{194}$$

and the above problem is solved if  $I(K_1, T_1)$  and  $J(K_1, T_1)$  or  $I(K_2, T_2)$  and  $J(K_2, T_2)$  can be compared. The four payoffs of (194) can be rearranged according to the matrix form in Table 4. If  $I(K_1, T_1) \leq J(K_1, T_1)$ , then, considering (194), the above matrix game admits a Nash equilibrium in pure strategies corresponding to the centralized choice of structure. On discrete games, among others, Luce and Raiffa [31] can be referred to. Conversely, if  $J(K_2, T_2) \leq I(K_2, T_2)$ , then the decentralized choice made by both parties is the Nash optimal.

Table 4. Payoff matrix.

		Tracking structure:	
		centralized	decentralized
Structure of the (minimizing) target.	centralized	$J(K_1, T_1)$	$I(K_1, T_1)$
	decentralized	$J(K_2, T_2)$	$I(K_2, T_2)$

Consequently, by studying the perfect information game in which both players are bound to jointly choose either structure, and using the above approach, the solution of the non-perfect information game in which neither player is sure of the other's choice of structure is also solved.

$I(K_1, T_1)$  is the performance achieved when the target plays the strategies  $K_1, T_1$ , optimal if the tracking team adopts the centralized structure when, actually, the tracking team adopts the decentralized structure, based on the assumption that the target plays accordingly. Therefore, the tracking filters are not fitted to the real control policy  $K_1, T_1$ . Let  $I^*(K, T)$  be the payoff of the filter optimized with respect to the very pair  $(K, T)$ . Then, due to optimality,

$$I(K, T) \leq I^*(K, T) \quad (195)$$

holds for the maximizing tracking team. And, in particular,

$$I(K_1, T_1) \leq I^*(K_1, T_1) , \quad (196)$$

which, together with (194) yields

$$I(K_2, T_2) \leq I^*(K_1, T_1) . \quad (197)$$

$(K_2, T_2)$  is the control pair assumed by the tracking team to optimize I. Therefore,

$$I^*(K_2, T_2) = I(K_2, T_2) \quad (198)$$

and, eventually

$$I^*(K_2, T_2) \leq I^*(K_1, T_1) . \quad (199)$$

Similar demonstration performed on  $J(K_2, T_2)$  gives

$$J^*(K_1, T_1) \leq J^*(K_2, T_2) . \quad (200)$$

(199) and (200) form a set equivalent to (194). Therefore,

$$I^*(K_1, T_1) \leq J^*(K_1, T_1) \rightarrow I(K_1, T_1) \leq J(J_1, T_1) , \quad (201)$$

$$J^*(K_2, T_2) \leq I^*(K_2, T_2) \rightarrow J(K_2, T_2) \leq I(K_2, T_2) .$$

Though more restrictive in the conclusions, working with  $I^*$  and  $J^*$  has the advantage that the performance computed by the tracking team and the real performance do coincide, thereby simplifying the computation task attempted in the next section.

As pointed out previously, neither the target nor the tracking team has access to the real value of  $I(K_1, T_1)$  or  $J(K_2, T_2)$  during the actual tracking phase; only a referee, having free access to both sides could compute these values. The performances computed by either side differ since they are based upon different assumptions. If a decision had to be taken according to these quantities, it would define a non-zero sum game which translates into a bimatrix game. This approach, a little more involved, though more satisfying for the players, is the one adopted in the example of Section 7.

##### 5. COMPARING $I(K_1, T_1)$ WITH $J(K_1, T_1)$

The target plays according to the centralized structure, corresponding to equations (159), (160), (172) to (179). It thinks it achieves a payoff computed on the basis of  $X_1(t_f)$  and  $P(t)$ .

The tracking team, on the other hand, plays according to the decentralized structure, described by equations (180) to (191), adopting the control policy  $L_1 = P_1 H_1^T S_1^{-1}$  and  $L_2 = P_2 H_2^T S_2^{-1}$  defined in (190), and assuming an achievement  $I(K_2, T_2)$  computed after  $X_2(t_f)$  and  $Q(t)$  as in (185).

Nevertheless, the true performance achieved is

$$I(K_1, T_1) = \text{tr}\{\bar{X}(t_f) - 0.5 \int_{t_0}^{t_f} \bar{Q}(t) dt\}, \quad (202)$$

where the over bars denote the true values, such that

$$\dot{\bar{X}} = (F+GK_1)\bar{X} + \bar{X}(F+GK_1)^T + GT_1G^T, \quad (203)$$

$$\dot{\bar{Q}} = 0.5 (\bar{P}_1 \bar{M}_2^T + \bar{P}_2 \bar{M}_1^T + \bar{P}_{12}),$$

where  $\bar{P}_1$  and  $\bar{P}_2$  propagate as

$$\begin{aligned} \dot{\bar{P}}_1 &= (F+GK_1)\bar{P}_1 + \bar{P}_1(F+GK_1)^T - P_1 H_1^T S_1^{-1} H_1 \bar{P}_1 - \bar{P}_1 H_1^T S_1^{-1} H_1 P_1 \\ &\quad + P_1 H_1^T S_1^{-1} H_1 P_1 + GT_1G^T, \end{aligned} \quad (204)$$

$$\begin{aligned} \dot{\bar{P}}_2 &= (F+GK_2)\bar{P}_2 + \bar{P}_2(F+GK_2)^T - P_2 H_2^T S_2^{-1} H_2 \bar{P}_2 - \bar{P}_2 H_2^T S_2^{-1} H_2 P_2 \\ &\quad + P_2 H_2^T S_2^{-1} H_2 P_2 + GT_1G^T, \end{aligned}$$

$$\dot{\bar{P}}_{12} = GT_1G^T.$$

The initial conditions are identical. Computing  $I(K_1, T_1)$  amounts to solving in parallel three differential games, some equations being interdependent as (204) shows. When  $I^*(K_1, T_1)$  is studied, the performance computed by the tracking team is the real performance; therefore equations (202) to (204) are irrelevant, resulting in considerable simplifications.

$I(K_1, T_1)$  is to be compared with  $J(K_1, T_1)$  which actually corresponds to the performance assumed by the target and expressed by (172). Simulation of the above, for even a two dimensional case, amounts to 68 scalar differential equations, 16 switching functions and 24 parameters from trial and error (the 2-vs.-1 game is a 4-point boundary-value problem). This task must be somewhat duplicated to compute  $J(K_2, T_2)$ . The complexity is a characteristic of team games.

Since  $\bar{X}(t_0) = X(t_0)$ , (203) and (159) are identical propagation functions, therefore,  $\bar{X}(t_f) = X(t_f)$ . In other words, since, in both cases, the target plays the same strategy, it alters its strategy the same way. Thus, the two integral terms in (202) and (172) are to be compared. As a sufficient condition, their differential elements  $\bar{Q}(t)$  and  $P(t)$  are compared. If  $\bar{Q}(t) - P(t)$  is positive definite for all  $t$  in the interval considered (i.e.,  $\bar{Q}(t) \geq P(t)$ ), then  $I(K_1, T_1) \leq J(K_1, T_1)$ , and the centralized structure is to be chosen. If  $\bar{Q}(t) - P(t)$  is negative definite, then the decentralized structure is best. Since  $\bar{Q}(t_0) = P(t_0)$ , the study focuses on  $\dot{P}$  and  $\dot{\bar{Q}}$ .

Next, the identities

$$\bar{M}_1 + \bar{M}_2 = \bar{M}_1^T + \bar{M}_2^T = I, \quad (205)$$

$$(\bar{P}_i - \bar{P}_{12}) \dot{\bar{M}}_i^T = -\bar{M}_i (\dot{\bar{P}}_1 + \dot{\bar{P}}_2 - 2\dot{\bar{P}}_{12}) \bar{M}_i^T + \bar{M}_i (\dot{\bar{P}}_i - \dot{\bar{P}}_{12}),$$

are recognized, and  $\Delta P_i = P_i - \bar{P}_i$  is introduced as the difference between the covariance computed by the trackers and the real one.

Then, after some cumbersome algebra,

$$\begin{aligned} \dot{\bar{Q}} = & (F+GK_1)\bar{Q} + \bar{Q}(F+GK_1)^T - \bar{Q}H^T S^{-1} H Q + G^T_1 G^T \\ & - \bar{M}_1 \bar{B}_1 \bar{P}_{12} \bar{M}_2^T - (\bar{M}_1 \bar{B}_1 \bar{P}_{12} \bar{M}_2^T)^T - \bar{M}_2 \bar{B}_2 \bar{P}_{12} \bar{M}_1^T - (\bar{M}_2 \bar{B}_2 \bar{P}_{12} \bar{M}_1^T)^T, \end{aligned} \quad (206)$$

where

$$\begin{aligned} \bar{B}_1 = & F + GK_1 - \bar{P}_2 R_2 - 0.5 \bar{M}_1^{-1} \bar{M}_2 (\bar{P}_{12} R_2 + \Delta P_1 R_1 \Delta P_1 P_{12}^{-1}), \\ \bar{B}_2 = & F + GK_1 - \bar{P}_1 R_1 - 0.5 \bar{M}_2^{-1} \bar{M}_1 (\bar{P}_{12} R_1 + \Delta P_2 R_2 \Delta P_2 P_{12}^{-1}), \end{aligned} \quad (207)$$

and  $R_i = H_i^T S_i^{-1} H_i$ .

(206) is to be compared with

$$\dot{P} = (F+GK_1)P + P(F+GK_1)^T - PH^T S^{-1} HP + G^T_1 G^T. \quad (177)$$

Two remarks are in order at this point. First, the difference between both equations is seen to come from the feedback control and from the quadratic term. Then, when the target decides not to use its mixed strategy,  $P_{12}$  remains zero and  $\dot{\bar{Q}}$  is identical to  $\dot{P}$ ; thus, both structures perform equally.

Matrices  $\bar{M}_1$ ,  $\bar{P}_{12}$  are positive definite, therefore, if  $\bar{B}_1$  and  $\bar{B}_2$  are negative definite then  $\bar{Q}(t) \geq P(t)$  is ensured and the centralized structure chosen.

Except for the term  $(F+GK_1)$ , both  $\bar{B}_1$  and  $\bar{B}_2$  are negative definite terms; thus, in order for the centralized structure to be chosen,  $F+GK_{\max}$  must not be so positive definite as to force the integral of  $\bar{Q}$  to be larger than the integral of  $P$ . Since it is difficult to estimate bounds on  $\bar{B}_i - (F+GK_1)$ , unless performing the actual simulation, a sufficient condition to ensure the choice of the centralized structure is  $F+GK_{\max} \leq 0$  or  $GK_{\max} \leq -F$ . As an

example, if  $F$  is negative definite and little positive feedback is used, then the centralized structure is chosen.

When  $I^*(K_1, T_1)$  is compared to  $J^*(K_1, T_1)$  then  $P_i = \bar{P}_i$  and  $\Delta P_i = 0$ ; thus it is more difficult for  $\bar{B}_1$  and  $\bar{B}_2$  to be negative definite.

#### 6. COMPARING $J(K_2, T_2)$ with $I(K_2, T_2)$

This is the dual case to the one developed previously. The actual covariance is  $\bar{P}$ , where

$$\begin{aligned} \dot{\bar{P}} = & (F+GK_2)\bar{P} + \bar{P}(F+GK_2)^T - PH^T S^{-1} H \bar{P} - \bar{P} H^T S^{-1} H P \\ & + PH^T S^{-1} H P + GT_2 G^T . \end{aligned} \quad (208)$$

The target assumes a decentralized structure, computing  $K_2, T_2$  and a covariance  $Q$  according to equations (180) to (192) when the tracking team computes its control  $L = PR$  according to the centralized structure described by equations (159), (160), (172) to (179).

$\dot{Q}$  is compared to  $\dot{\bar{P}}$ , using a similar derivation; i.e.,

$$\begin{aligned} \dot{Q} = & (F+GK_2)Q + Q(F+GK_2)^T - GH^T S^{-1} H Q + GT_2 G^T - M_1 B_1 P_{12} M_2^T \\ & - (M_1 B_1 P_{12} M_2^T)^T - M_2 B_2 P_{12} M_1^T - (M_2 B_2 P_{12} M_1^T)^T , \end{aligned} \quad (209)$$

where

$$\begin{aligned} B_1 = & (F+GK_2) - P_2 R_2 - 0.5 M_1^{-1} M_2 (P_{12} R_2 - \Delta P R_1 \Delta P P_{12}^{-1}) , \\ B_2 = & (F+GK_2) - P_1 R_1 - 0.5 M_2^{-1} M_1 (P_{12} R_1 - \Delta P R_2 \Delta P P_{12}^{-1}) , \end{aligned} \quad (210)$$

$$\Delta P = P - \bar{P} .$$



A sufficient condition for the decentralized structure to be chosen is that  $B_1$  and  $B_2$  be positive definite. Confronting (210) and (207), the term involving  $\Delta P$  plays, in both cases, a favorable role in forcing a definite conclusion, when, if  $J^*(K_2, T_2)$  and  $I^*(K_2, T_2)$  are computed, then  $\Delta P = 0$  and that factor disappears. Again, it is difficult to evaluate (210). The decentralized structure is adopted, for example, when  $F$  and  $GK_{\min}$  are positive definite matrices of fairly large norm.

As a last remark, at  $t = t_f$ ,  $T = 0$ . Thus, for games of short total duration  $t_f - t_0$ , no switch in  $T$  can occur; then  $P_{12} = 0$  and, consequently, both structures are identical. Otherwise, depending on the very game studied, in particular the target capabilities and the initial state, either structure might be chosen.

## 7. A MODIFIED SCALAR CASE

A simplified scalar, and slightly modified example is developed here to illustrate further some particularities of team games.

To focus on the sole study of the effect of the mixed strategy, the feedback control  $K$  is forced to zero; also  $F = 0$ ,  $G = 1$ ,  $H_1 = H_2 = 1$ , and  $T$  is constrained to  $[0, 1]$ , where the maximum tolerable self-added noise in the target's dynamics is 1.

Then, the state and observation equations for the centralized case are

$$\begin{aligned} \dot{x} &= \zeta \\ z_1 &= x + s_1, \\ z_2 &= x + s_2. \end{aligned} \tag{211}$$

The two measurements  $z_1$  and  $z_2$  are combined into the equivalent measurement  $z$ :

$$z = x + s, \quad (212)$$

where the equivalent noise  $s$  has covariance  $S = S_1 S_2 / (S_1 + S_2)$ . The covariances associated with  $x$  and the error estimate propagate as

$$\dot{\hat{x}} = T, \quad (213)$$

$$\dot{\hat{p}} = -2LP + L^2 S + T.$$

The performance index and Hamiltonian are

$$J(T_1) = x(t_f) - 0.5 \int_{t_0}^{t_f} P(t) dt, \quad (214)$$

$$H = -0.5 P + \Lambda_x T_1 + \Lambda_p (-2LP + L^2 S + T_1),$$

and the necessary conditions of optimality yield the optimal control variable  $L$  as

$$\frac{\partial H}{\partial L} = \Lambda_p (-2P + 2SL) = 0, \quad \text{or} \quad L = P/S. \quad (215)$$

Substitution back into (213) yields

$$\dot{\hat{p}} = -P^2/S + T_1, \quad (216)$$

when the costate variables propagate as

$$\begin{aligned} \dot{\Lambda}_x &= 0, \quad \Lambda_x(t_f) = 1, \\ \dot{\Lambda}_p &= P\Lambda_p + 0.5, \quad \Lambda_p(t_f) = 0. \end{aligned} \quad (217)$$

The Pontryagin maximum principle is applied to find the optimal control  $T_1$  as

$$\Lambda_x + \Lambda_p < 0 \rightarrow T = 1 , \quad (218)$$

$$\Lambda_x + \Lambda_p > 0 \rightarrow T = 0 ,$$

Singularities play an important role whenever bang-bang policies are present for differential games. A reference on the subject is provided by Forhouar and Leondes [32].

A singularity of order  $n$  at the switching point arises whenever the generalized Legendre-Clebsch condition is met, i.e.,

$$\frac{\partial^n}{\partial T^n} \left[ \frac{\partial^2}{\partial t^2} \left[ \frac{\partial H}{\partial T} \right] \right] < 0 . \quad (219)$$

Furthermore, stationarity along the singular arc implies that

$$\frac{\partial}{\partial t} \left[ \frac{\partial H}{\partial T} \right] = 0 , \quad (220)$$

and

$$\frac{\partial^2}{\partial t^2} \left[ \frac{\partial H}{\partial T} \right] = 0 . \quad (221)$$

Together with the switching condition, this yields three equations to fix the three unknowns  $P$ ,  $\Lambda_p$  and  $T$ . Then, the equations are solved forward in time and backwards in time on either side of the singular arc, yielding the solution.

The decentralized structure has the performance index

$$J(T_2) = X(t_f) - 0.5 \int_{t_0}^{t_f} P_1(t)P_2(t)/(P_1(t) + P_2(t))dt. \quad (222)$$

It differs somewhat from (185) and (180). This modification of the decentralized structure is assumed by both parties. Such an assumption over a non-optimal structure might be questioned as far as the target is concerned, but the purpose here is to study the team game peculiarities rather than choosing a given tracking structure. A study similar to the previous one yields the equations for the two Kalman filters and target policy as

$$\begin{aligned} \dot{x} &= \zeta, \\ z_1 &= x + s_1, \end{aligned} \quad (211)$$

$$z_2 = x + s_2,$$

$$\begin{aligned} \dot{x} &= T_2, & x(t_0) &= 1, \\ \dot{P}_1 &= -P_1^2/S_1 + T_2, & P_1(t_0) &= P_{10}, \end{aligned} \quad (223)$$

$$\dot{P}_2 = -P_2^2/S_2 + T_2, \quad P_2(t_0) = P_{20},$$

$$\begin{aligned} \dot{\Lambda}_x &= 0, & \Lambda_x(t_f) &= 1, \\ \Lambda_{P1} &= 2P_1\Lambda_{P1}/S + 0.5 P_2^2/(P_1 + P_2)^2, & \Lambda_{P1}(t_f) &= 0, \end{aligned} \quad (224)$$

$$\Lambda_{P2} = 2P_2\Lambda_{P2}/S + 0.5 P_1^2/(P_1 + P_2)^2, \quad \Lambda_{P2}(t_f) = 0,$$

$$\begin{aligned} \Lambda_x + \Lambda_{P1} + \Lambda_{P2} &< 0 \rightarrow T_2 = 1, \\ &> 0 \rightarrow T_2 = 0. \end{aligned} \quad (225)$$

A possibility for a singular arc arises again whenever the switching function is equal to zero. Stationarity along the singular arc implies that the first two time derivatives of the switching function be zero. These three equations cannot fix the five unknowns, namely  $P_1$ ,  $P_2$ ,  $\Lambda_{P1}$ ,  $\Lambda_{P2}$  and  $T_2$ . In the five-dimensional space spanned by the unknowns, a manifold is defined of two dimensions, constrained further by the restrictions on time,  $t \in [t_0, t_f]$  and on  $T_2 \in [0, 1]$ . Reaching such a manifold happens under rarely met initial conditions, as the simulation proved. The conclusion is that the singularity does not play a major role in the decentralized structure, unlike the centralized structure.

To compare both structures, the differential equation governing the propagation of the error covariance of the decentralized structure can be computed as

$$\dot{Q} = -Q^2/S + T_2 - 2T_2 P_1 P_2 / (P_1 + P_2)^2, \quad (226)$$

and is compared with (213).

If the target is passive, then  $T_2 = 0$  and both structures are equivalent. Otherwise, for  $T_2 = T_1$ ,  $P(t) \geq Q(t)$  due to the fact that the term  $P_1 P_2 / (P_1 + P_2)^2$  is bounded by 0 and 0.25. Thus,  $I^*(T) \geq J^*(T)$  for any given policy  $T$ , and, as shown previously, it implies that the decentralized structure is to be chosen.

Simulation was performed for noise levels  $S_1 = 8$  and  $S_2 = 4$ . Figures 28 and 29 show the optimal solutions corresponding to two different initial conditions. The resulting control policies differ widely but a higher covariance in the centralized case is compensated

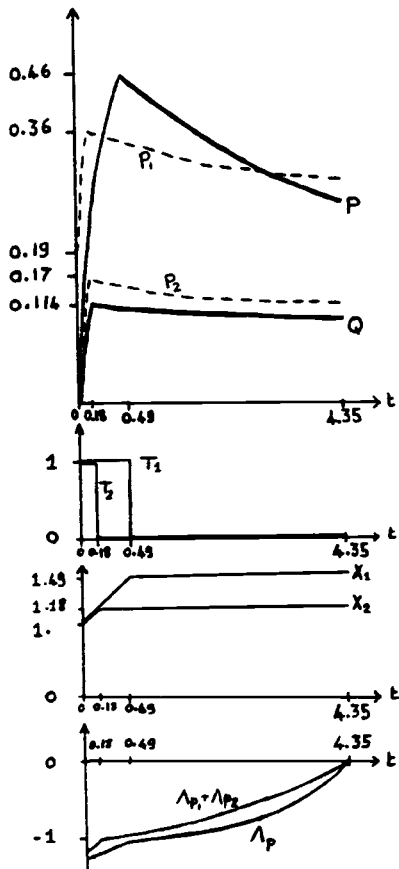

$J(T_1) = 0.731$  (One Switch)  
 $I(T_2) = 0.843$  (One Switch)

Figure 28. Optimal trajectories. for case 1.

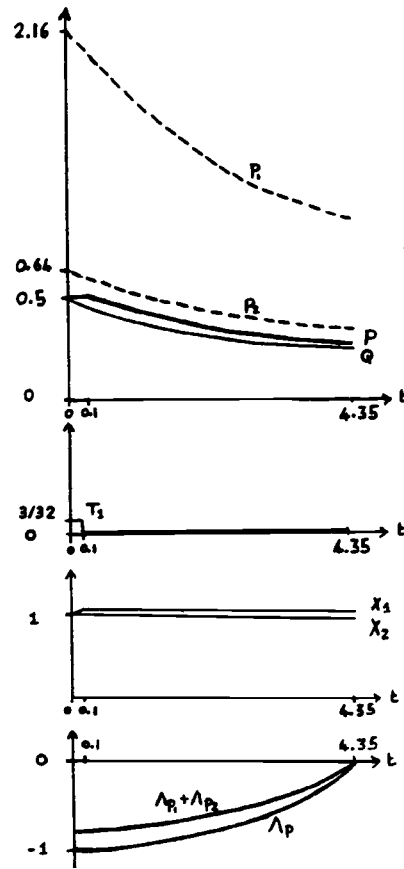

$J(T_1) = 0.223$  (Singular arc)  
 $I(T_2) = 0.385$  ( $T_2=0$  uniformly)

Figure 29. Optimal trajectories for case 2.

to some extent by an increase in  $X(t_f)$ . As expected,  $I(K_2, T_2) \geq J(K_1, T_1)$  is verified.

More cooperation, resulting in a larger difference in  $J(K_1, T_1)$  and  $I(K_2, T_2)$  would have happened if both measurements had identical noise levels as previous results by Mohler, Kolodziej and Bugnon [22] show.

Thus far, the target and the ships were assumed to play according to either the centralized scheme or the decentralized scheme. When the choice of the opponent is unknown, both parties must choose a structure and play accordingly. As explained earlier, in that non-perfect information case, the performance indices differ and the game is of the non-zero sum type. It defines a bimatrix game which, for the case of Figure 28, is given by Table 5.

Table 5. Performances for non-perfect information game.

		Target strategies				Target strategies	
		a	b			a	b
Ships strategies	a	0.94	0.96	Ships strategies	a	0.94	1.04
	b	0.84	0.73		b	0.76	0.73
Ships performance				Target performance			

A Nash equilibrium in pure strategies exists for this example. It is unique and corresponds to the assumption of a decentralized structure made by both parties.

Actually, the open-loop nature of the structures depicted in Figures 26 and 27 allows an implementation of both strategies in parallel by the tracking team, a simple device could compare the

performance indices obtained from both schemes in order to select the best choice.

Viewed from such a perspective, the above bimatrix game becomes a Stackelberg or leader-follower game in which the target (the leader) announces its strategy first, and the ships (the followers) react accordingly. The Stackelberg equilibrium and the Nash equilibrium coincide for all five examples run in simulation. The conclusion is that both the target and the ships should play according to the decentralized structure, even in the event of non-perfect information.

## 8. CONCLUSION

A stochastic team differential game is presented, in which the target, by the use of a mixed strategy, has a direct control over the cross correlation between the members of the tracking team. The study is conducted in the general case and two important features of team games are demonstrated; they are as follows:

i) Depending on the kind of cooperation allowed between the team members, various games can be defined. It ranges from independent players up to totally collaborating members. In the latter case, certain choices must be made in the game structure which are not readily apparent in the 1-vs.-1 case.

ii) Hierarchical structures naturally arise with the classical trade off between performance and computational burden.

Two particular game structures, i.e., a centralized and a decentralized one, are compared, yielding a matrix-game study in a



non-perfect information frame. The choice of structure can be expressed as a (hierarchical) Stackelberg game due to the open-loop nature of the problem. It is remarkable that the same problem can be studied as a zero-sum matrix game, a non-zero sum bimatrix game and a Stackelberg game.

Complexity and dimensionality are major issues in team games. For example, to use the same approach as in this chapter, there are 15 ways to combine the measurements of a 4-vs.-1 team game, resulting in a 15 by 15 matrix game!

Both structures yield equivalent results whenever the target does not use mixed strategy, or is passive. Otherwise, sufficient conditions, that depend on the game dynamics, are derived under which one or the other structure is to be chosen.

The centralized structure might be viewed as a convenient way to alleviate difficulties by rejecting the game study up to a unique higher player in the hierarchy. Nevertheless, the advantages of the decentralized structure are numerous. Among others, the structure is more practical, by distributing the computational burden among the players. Thus it can be adapted to several team configurations or can recover better from individual failures. Also, the example shows that it is a lot less likely that a singularity will be encountered in a team game.

## IX. A NONLINEAR APPROACH TO THE DIRECTION-FINDING PROBLEM

### 1. INTRODUCTION

Deterministic team games presented in the first chapters are of perfect information. That is, the number of players is common knowledge, the state of the pursuers and evader is perfectly known by both parties. In stochastic team games as the one studied in Chapter VIII, the second requirement is relaxed somewhat, since the players are measuring the opponent's state corrupted by additive noise. Nevertheless, at time  $t = t_0$ , the game is clearly defined in terms of the number of the players. In a practical, competitive situation, both the pursuers and the evaders, before the theoretical beginning of the game and as the game evolves, are searching for information about the other party. Then the problem is one of detection, localization and identification. In the underwater case, from a set of spatially distributed measurements, high resolution techniques such as the direction-finding techniques allow retrieval of both the number and the direction of arrival of incident waves. These waves are unwillingly emitted by the pursuers (machineries, communications, etc.), or, in a competitive situation, by potential jammers. Obviously high-power jamming can be used, to hide a given source. But even a low power jammer, which emits an identical signature away from the source, is efficient since classical, i.e., linear, direction-finding

methods fail in the case where coherent signals are received, as shown below.

Eigenstructure based methods have been successfully applied to the harmonic retrieval problems (Pisarenko [33]). Likelihood methods are used to derive detection tests for the number of sources, as studied by several authors: Bienvenu and Kopp [34], Rissanen [35], Wax and Kailath [36]. On the other hand, the related problem of estimators for the location of the sources has been studied by Bienvenu and Kopp [34] and Henderson [37].

These direction-finding methods based on the eigenstructure usually rely on the hypothesis that the signals are not coherent, i.e. not fully correlated. Unfortunately, coherent sources occur frequently in practical problems, in case of jamming or in case of multipath propagation. When this hypothesis is no longer valid, the spectral density matrix of the sources becomes singular. This results in an inconsistency in the eigenstructure method: though  $u$  sources are detected, the associated direction vectors are not proper. Then, for example, linear processing techniques performed by Henderson [37] propagate the singularity of the source spectral density matrix, and the methods described fail.

Shan, Wax and Kailath [38] propose a method to recover from coherent sources by averaging spectral densities computed from different linear subarrays, taking advantage of the regular spacing of the sensors. This spacial smoothing approach trades off, in fact, half the effective aperture to recover from the possible coherence of the sources.

The nonlinear approach developed below solves the case where all the sources are coherent. It can be applied to any type of array and shows drastic improvements in terms of minimal aperture when the number of coherent sources is high. Multiplicative nonlinear signals are built by convolution operations on the data to provide a sufficient number of Mth-order direction vectors to solve the problems. In general, the minimum number of sensors required to solve a particular problem is theoretically independent of the total number of sources, but rather depends on the number of uncoherent sources. The nonlinear method also provides the coherence coefficients between the sources, unlike the method by Shan, Wax and Kailath [38]. Formulae relating the number of sources to the order of the nonlinear method required are also provided. A brief discussion of the practical limitations of the method concludes the chapter.

## 2. PROBLEM STATEMENT

$n$  wideband sources  $s_k$  are impinging on a linear array from directions  $\theta_k$ . The linear array consists of  $d$  sensors located at distances  $D_i$  of sensor 1, such that  $0 = D_1 < \dots < D_d$ . Then the signals received at sensor  $r_i$  are

$$r_i(t) = \sum_{k=1}^n s_k \left( t - \frac{D_i \sin \theta_k}{c} \right) + n_i(t) \quad , \quad (227)$$

where  $c$  is the speed of propagation, and the additive noises at the  $i$ th sensor,  $n_i(t)$  are independent, identically distributed, Gaussian noises. When the noise field is unknown, techniques described by Paulraj and Kailath [39] can be applied.

For a finite observation time, the vectors  $R$ ,  $S$ ,  $N$  are defined as

$$\begin{aligned} R^T(\omega) &= [R_1(\omega), \dots, R_d(\omega)] , \\ S^T(\omega) &= [S_1(\omega), \dots, S_n(\omega)] , \\ N^T(\omega) &= [N_1(\omega), \dots, N_d(\omega)] , \end{aligned} \quad (228)$$

where  $R_i(\omega)$ ,  $S_k(\omega)$  and  $N_i(\omega)$  are the Fourier transforms of  $r_i(t)$ ,  $s_k(t)$  and  $n_i(t)$ . Then the Fourier transform of (227) yields

$$R_i(\omega) = \sum_{k=1}^n e^{-j\omega\tau_{ik}} s_k(\omega) + N_i(\omega) , \quad (229)$$

where  $\tau_{ik} = \frac{D_i}{c} \sin \theta_k$ . More generally,

$$R(\omega) = A_1(\omega) S(\omega) + N(\omega) , \quad (230)$$

and matrix  $A_1(\omega)$  is the (first-order) direction matrix

$$A_1(\omega) = \begin{bmatrix} 1 & \dots & 1 \\ e^{-j\omega\tau_{11}} & \dots & e^{-j\omega\tau_{1n}} \\ \vdots & & \vdots \\ e^{-j\omega\tau_{d1}} & \dots & e^{-j\omega\tau_{dn}} \end{bmatrix} \quad (231)$$

whose columns are the direction vectors of sources  $s_k$ :

$$\vec{d}_k^T(\omega) = [1, e^{-j\omega\tau_{1k}}, \dots, e^{-j\omega\tau_{nk}}] . \quad (232)$$

Multiplying (230) by its conjugate transpose, and taking expectations, for a sufficiently long observation time, the result converges in the mean to the spectral density matrix with the usual

covariance problems associated with the periodogram estimate for finite-length samples. Now this estimate of the (first-order) spectral density  $L_1(\omega)$  is given by

$$L_1(\omega) = A_1(\omega) E(S(\omega)\bar{S}(\omega)) \bar{A}_1(\omega) + E(N(\omega)\bar{N}(\omega)) , \quad (233)$$

where the overbar denotes the conjugate transpose. Or, dropping the arguments for short,

$$L_1 = A_1 P_1 \bar{A}_1 + \sigma^2 I , \quad (234)$$

with

$$P_1 = E(S(\omega)\bar{S}(\omega)) \quad (235)$$

and  $\sigma^2$  is the Gaussian noise spectral density coefficient.

Equation (234) has the desired structure to apply the eigenstructure method. If  $P_1$  has rank  $n$ , i.e., if no two sources are coherent, the  $d$  by  $d$  spectral density matrix  $L_1$  has  $n$  eigenvalues larger than  $\sigma^2$  and  $d - n$  identical eigenvalues equal to  $\sigma^2$ . The associated eigenvectors are orthogonal to the columns of the direction matrix  $A_1$ , i.e., to the direction vectors.

If two sources are coherent, e.g.,  $s_2 = \alpha s_1$ , then  $P_1$  has rank  $n - 1$  and the  $d - n + 1$  eigenvectors are not orthogonal to the direction vectors as defined in (232) but are orthogonal to the  $d$  by  $(n - 1)$  direction matrix

$$A_1 = \begin{bmatrix} 1 + \alpha & 1 & \dots & 1 \\ e^{-j\omega\tau_{11}} + \alpha e^{-j\omega\tau_{12}} & e^{-j\omega\tau_{13}} & \dots & e^{-j\omega\tau_{1n}} \\ \vdots & \vdots & \ddots & \vdots \\ e^{-j\omega\tau_{d1}} + \alpha e^{-j\omega\tau_{d2}} & e^{-j\omega\tau_{d3}} & \dots & e^{-j\omega\tau_{dn}} \end{bmatrix} \quad (236)$$

with a compound direction vector in the first column, as a function of three unknowns, namely  $\theta_1$ ,  $\theta_2$  and  $\alpha$ .  $A_1$  has one less column compared to (231).

If there are only  $d = n + 1$  sensors, then there are only two eigenvalues equal to  $\sigma^2$  with eigenvectors that are orthogonal to the compound direction vector. This provides two equations that cannot fix the three unknowns and the problem cannot be solved using this method, as pointed out in [38].

### 3. THE EIGENSTRUCTURE GENERATING FUNCTION

Mth-order signals, from  $r_{i,1}(t) = r_i(t)$  down to  $r_{i,M}(t)$  are constructed from the definition

$$r_{i,M}(t) = r_{i,M-1}(t) * r_i(t), \quad (237)$$

where  $*$  denotes the convolution operator. Then, the corresponding Mth-order vector  $R_M$  is

$$R_M^T = [R_1^M, R_2^M, \dots, R_d^M], \quad (238)$$

and it follows that the Mth-order spectral density matrix is defined as

$$L_M(\omega) = E[R_M(\omega) \bar{R}_M(\omega)], \quad (239)$$

or

$$L_M = E \begin{bmatrix} (R_1 \bar{R}_1)^M & (R_1 \bar{R}_2)^M & \dots & \cdot \\ (R_2 \bar{R}_1)^M & (R_2 \bar{R}_2)^M & \dots & \cdot \\ \cdot & \cdot & \cdot & \cdot \\ \cdot & \cdot & \cdot & \cdot \end{bmatrix} \quad (240)$$

Introducing a new matrix operator  $\Delta$ ,  $R_M$  is defined as the integer Mth power of R,

$$R_M(\omega) = R(\omega)^{\Delta M}, \quad (241)$$

in terms of  $\Delta$  products. E.G. when  $M = 2$ , each matrix element is simply squared.

$\Delta$  performs a component to component multiplication, i.e.

$$A \Delta B = \leftrightarrow c_{ij} = a_{ij} \cdot b_{ij}, \quad (242)$$

where it is implicit that matrices A, B and, of course, C are of identical dimensions.

Applied to p by q matrices, useful identities are

$$A \Delta B = B \Delta A,$$

$$A \Delta (B \Delta C) = (A \Delta B) \Delta C,$$

$$\overline{A \Delta B} = \overline{A} \Delta \overline{B}, \quad (243)$$

$$(A + B) \Delta C = A \Delta C + B \Delta C,$$

$$I \Delta I = I,$$

and for n by 1 vectors,

$$(A \Delta B) \overline{C \Delta D} = (\overline{AC}) \Delta (\overline{BD}) = (\overline{AD}) \Delta (\overline{BC}), \quad (244)$$

$$(AB)^{\Delta M} = A^{\Delta M} B^{\Delta M},$$

and, by definition, it is assumed that



$$(AD) \Delta (BC) = AD \Delta BC . \quad (245)$$

Applied to complex scalars,  $\Delta$  is the regular scalar multiplication, i.e.

$$t^{\Delta M} = t^M . \quad (246)$$

The  $\Delta$ -exponential of matrix A takes a form analogous to the classical matrix exponential:

$$e^{\Delta(A)} = \sum_{M=0}^{\infty} A^{\Delta M} / M! , \quad (247)$$

where the regular matrix product has been replaced by the  $\Delta$ -product.

Let an Mth-order spectral-density generating function be given by

$$\Phi_{\Delta RR}^-(t) = E[e^{\Delta(RRt)}] . \quad (248)$$

Then, using definition (248) and properties (244), (248) yields

$$\Phi_{\Delta RR}^-(t) = \sum_{M=0}^{\infty} E((RR)^{\Delta M}) t^M / M! , \quad (249)$$

where

$$L_M = E((RR)^{\Delta M}) \quad (250)$$

is immediately identified. Thus

$$\Phi_{\Delta RR}^-(t) = \sum_{M=0}^{\infty} L_M t^M / M! , \quad (251)$$

and hence the name of Mth-order spectral-density generating function.

As an example,  $L_2$  is computed as

$$L_2 = E((\overline{RR})^{\Delta 2}) = E((A_1 \overline{SSA_1} + A_1 \overline{SN} + \overline{NSA_1} + \overline{NN})^{\Delta 2}) , \quad (252)$$

Then, using the independence of the noises with respect to the sources, for Gaussian noises, odd powers of  $N$  and  $\overline{N}$  are averaged out. Moreover, terms as  $E(N \Delta N)$  and  $E(\overline{N} \Delta \overline{N})$  go to zero since

$$E(N_i \Delta N_i) = \mathcal{F} (E(n_i(t) * n_i(t)) , \quad (253)$$

where  $\mathcal{F}$  is the Fourier transform operator.  $E(n_i(t) * n_i(t))$  is the correlation estimate between  $n_i(t)$  and  $n_i(-t)$  and is expected to be zero since, for any time shift  $\tau$ , at most one point is correlated.

Thus  $L_2$  is equal to

$$L_2 = B_2 + 4 B_1 \Delta \sigma^2 I + E((\overline{NN})^{\Delta 2}) , \quad (254)$$

where

$$B_M = E((A_1 \overline{SSA_1})^{\Delta M}) , \quad (255)$$

and, for Gaussian noises,

$$E((\overline{NN})^{\Delta M}) = \frac{(2M)!}{M! 2^M} \sigma^{2M} I . \quad (256)$$

More generally, it can be shown that

$$L_M = \sum_{p=0}^M B_p \binom{p}{M}^2 \Delta E((\overline{NN})^{\Delta(M-p)}) , \quad (257)$$

with  $B = I$ , and  $\binom{p}{M}$  is the binomial coefficient, or

$$L_M = B_M + \sum_{p=0}^{M-1} B_p \Delta \frac{M!^2 (2(M-p))!}{(M-p)! p! 2^{M-p}} \sigma^{2(M-p)} I . \quad (258)$$

Let  $K_M$  be the  $M$ th-order eigenstructure matrix defined as

$$K_M = B_M + \sigma^{2M} I . \quad (259)$$

Then  $K_M$  can be computed from  $L_M$  by the recurrent relation

$$K_1 = L_1$$

$$K_M = L_M - \sum_{p=1}^{M-1} K_p \sigma^{2(M-p)} \frac{M!^2 (2(M-p))!}{(M-p)! p! 2^{2(M-p)}} \Delta I + \quad (260)$$

$$\sum_{p=1}^{M-1} \sigma^{2(M-p)} \frac{M!^2 (2(M-p))!}{(M-p)! p! 2^{2(M-p)}} I - \sigma^{2M} \frac{(2M)!}{M! 2^M} I + \sigma^{2M} I .$$

$K_M$  and  $L_M$  differ only by their diagonal components  $\sigma^2$  is estimated as the smallest eigenvalue of  $L_1$ .

Then, the eigenstructure generating function is defined as

$$\Phi_{\square RR}(t) = \sum_{M=0}^{\infty} K_M t^M / M = E(e^{\square(RRt)}) , \quad (261)$$

or

$$K_M = E((\overline{RR}) \square^M) , \quad (262)$$

where the  $\square$ -operator is defined a posteriori from relations (260) and (262).

When all the sources are coherent,  $A_1$  is composed of a unique compound vector and

$$B_M = E((A_1 \overline{SSA_1})^{\Delta M}) = A_{MM} \overline{A_M} , \quad (263)$$

where

$$A_M = A_1^{\Delta M} \quad (264)$$

is the Mth-order compound vector and

$$P_M = P_1^{\Delta M} \quad (265)$$

is now a scalar (dimension 1).

Then the  $d$  by  $d$   $M$ th-order eigenstructure matrices  $K$  have the prescribed structure

$$K_M = A_M P_M \bar{A}_M + \sigma^{2M} I. \quad (266)$$

Thus 1 of the  $d$  eigenvalues is larger than  $\sigma^{2M}$ , the remaining  $d - 1$  eigenvalues are equal to  $\sigma^{2M}$  and the associated eigenvectors are orthogonal to the columns of matrices  $A_M$ , i.e. to the  $M$ th-order direction vectors, thereby yielding, for each other  $M = 1, 2, \dots$  another set of equations which are functions of the unknown parameters.

Moreover, the  $M$ th-order direction vector has for components the components of the corresponding first-order direction vector raised to power  $M$ . Thus they are, in general, independent vectors and functions of the very same parameters.

The  $M$ th-order eigenstructure method is applied to matrices  $K_1, K_2, \dots, K_M$ . Consequently there are no theoretical limitations to  $M$ , nor to the number of equations provided by the method. The only constraint is that there must be at least one eigenvalue equal to  $\sigma^{2M}$ , and thus  $d - n \geq 1$  is enforced, i.e.  $d \geq 2$  where  $n = 1$  is now the order of the source spectral-density matrix, which is the number of non-coherent sources, 1 in the case where all sources are coherent.

#### 4. MINIMUM SENSOR CONFIGURATIONS

The incident source signals impinging on the array are classified

by  $(n:u,c,k)$  where

$n$  is the total number of sources,

$u$  is the number of non-coherent sources,

$c$  is the number of coherent sources,

$k$  is the maximum number of coherent sources present in uncorrelated groups of sources, and  $k$  is smaller than  $n$ .

Then it can be shown that

$$n = u + c ,$$

$$k + 1 \in [ \lfloor n/u \rfloor , c + 1 ] \quad \text{for } u > 1 , \quad (267)$$

$$k + 1 = c + 1 \quad \text{for } u = 1 ,$$

and  $\lfloor \cdot \rfloor$  is such that  $\lfloor n/u \rfloor$  is the greatest integer smaller or equal to  $n/u$ .

For an array of  $d$  sensors, receiving signals from  $n$  directions, the classical, i.e. first-order, method is applied first. If coherent sources are present, the  $u$  non-coherent sources are detected and only  $q \leq u$  orthogonal proper direction vectors are computed. Then there are  $n - u = c$  coherent sources that are a function of the  $u - q$  non-coherent ones. It must be emphasized that, at this point,  $c$  is to be guessed by the experimenter. Nevertheless, a large value for  $c$  solves all problems where  $c$  is smaller but at the expense of more computation. A trial and error procedure, choosing first  $c = 1$  and increasing to  $c = 2$  if no match is found is also possible.

The nonlinear method is applied when all the sources are coherent. In that case  $u = 1$  and  $k = n - 1$ . The sources are

$$s_i(t) = \alpha_i s_1(t) , \quad (268)$$

$i = 1, 2, \dots, n$ ,  $\alpha_i$  are complex constants,  $\alpha_1 = 1$ . The compound direction vector is

$$A_1 = \vec{d}_1 = \sum_{i=1}^n \alpha_i \vec{d}_i^* , \quad (269)$$

where  $\vec{d}_i^*$  are the uncompounded direction vectors as defined in equation (231).  $\vec{d}_1$  is a function of  $2n - 1$  unknowns:  $n - 1$  coherence coefficients  $\alpha_i$  and  $n$  direction parameters  $\theta_i$ .

In the minimum configuration case, there is only one eigenvalue equal to  $\sigma^{2M}$  and thus, each order produces one more equation from the orthogonality of the corresponding eigenvector with the compound eigenvector  $\vec{d}_1^{\Delta M}$ .

Consequently, the minimum configuration to solve the problem is

$$\begin{aligned} d &= u + 1 = 2 \\ M &= 2n - 1 . \end{aligned} \quad (270)$$

When  $d = n + 1$ , then there are at least  $n$  minimum eigenvalues equal to  $\sigma^{2M}$ , as a consequence,  $n$  new equations are produced from each order. Thus the second-order nonlinear method produces  $2n$  equations that solve the problem in its entirety.

More generally if  $d_1$  is the minimum number of sensors required by the method described in [38],  $d_2$  by the second-order nonlinear method and  $d_M$  by the  $M$ th-order nonlinear method, then

$$\begin{aligned} d_1 &= n + k + 1 = 2n , \\ d_2 &= n + 1 , \\ d_M &= u + 1 = 2 . \end{aligned} \quad (271)$$

Figure 30 compares minimum sensor configurations that allow to solve the problem for these three methods. Gains in terms of sensors are substantial for high number of coherent sources. The required value of  $M$  in the  $M$ th-order method is indicated in parenthesis.

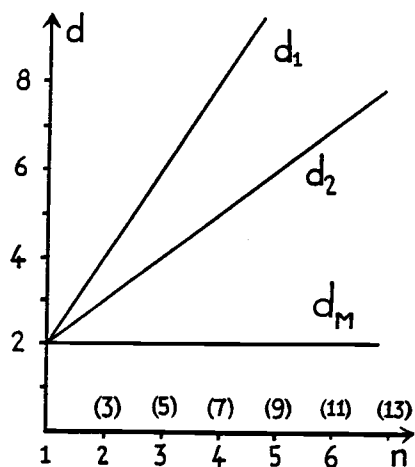

Figure 30. Minimum sensor configuration for  $n$  coherent sources.

## 5. CONCLUSION

The  $M$ th-order nonlinear method yields, theoretically, the receiving angles and the coherence coefficients in the case of coherent sources. For a constant number of sensors, an increased number of coherent sources is usually followed by an increase in the order of the non-linear method requested to solve the problem.

Practically, for a finite observation time  $T$ , the  $M$ th-order signals have lengths  $M.T$ , but even though they are longer, they do not converge any better than the first-order signals to the  $M$ th-order spectral-density matrices. Actually, for a short observation

time, the repeated convolutions have the drawback of enhancing the irregularities in the noise. This clearly sets a limitation on the practical order of the method, for a given observation time, added to the computational requirements to derive the Mth-order matrices.

Nevertheless, it must be underlined that, for each order, the smallest eigenvalue is  $\sigma^{2M}$ ; which provides a convenient way of checking degree of convergence for the corresponding estimated Mth-order matrix compared to the first order.

The most serious limitation of the method is that, so far, it can only be applied to the particular case where all the sources are coherent.



## X. CONCLUSIONS

Team differential games feature several particular problems. Classical N-player games are, generally, N point boundary value problems but an (N-1)-pursuer-1 evader team differential game includes N-2 extra unknowns due to the fact that optimality applies to the team as a unit and not to individuals. For minimum-time problems, these unknowns are modeled as strategic variables whose values quantify the activity of the pursuers. Singularities that play a major role in the solution of a two-player differential game do not appear nearly as important for team games. On the other hand, the study of the game of kind is a lot more complex and crucial.

Early choices on the kind of cooperation allowed between teammates are reflected in the form of the performance index, simpler choices yield formulae easily generalized at the expense of a reduced interaction level in the team, hampering the result. More powerful team structures can be treated classically only by increasing the dimensions of the game. Through a suitable definition of the reduced coordinates, convenient studies of team games can be conducted but depend on the type of analysis conducted for the very type of game.

Due to its relative simplicity, the one-versus-one game can often be studied quite extensively. In most instances, the addition of an extra pursuer to a team is not directly reflected on the form of the controls of the pursuers as it is on the control of the evader.

Moreover, useful time and performance limitations to the team game can be derived from the 1-versus-1 game. Then, it allows a study of the team game from geometrical analogies or the computation of approximate solutions which are tailored to a given game as the composition approximation or the simple suboptimal solution to the linear quadratic team game. The same approach can even yield the exact solution to the otherwise untractable problem of optimal location of a pursuer in a team. Maximum team controllability criteria though generally non-game optimal, still provide with handy relationships to approximate terminal time state unknowns.

Because of the complexity of team differential games, structures and hierarchies arise naturally. Analysis or computational burden is the reason for introducing structures that break the solution into easier steps, as in the games involving a minimum operator in the performance index that show two distinct phases or as the composition approximation. When the hierarchy that corresponds to the complete solution is prohibitively complex, a careful sensitivity study can yield suboptimal hierarchies to reduce both the information structure and the computations required.

The stochastic team differential game investigated shows that hierarchical choices must be made beforehand that reflect a team philosophy or an early strategic option. Decentralized structures are probably more adequately adapted to team games but optimality is usually not achieved.

The nonlinear approach to the direction finding problem addresses the problems of jamming and multipath propagation. Although

computationally costly, it shows great improvements when the coherence level of the received signals is high. For a given number of sensors, it enables the solution of a wider class of problems, but the observation time sets a limitation on the order of the method, thereby limiting the possibilities.

## XI. BIBLIOGRAPHY

1. BAR-SHALOM, Y., BIRMIWAL, K., "Variable Dimension Filter for Maneuvering Target Tracking", IEEE Trans. on Aerospace and Electronic Systems, Vol. AES-18,5, 621, 1982.
2. VON NEUMANN, J., MORGENSTERN, O., "Theory of Games and Economic Behaviour", Princeton Univ. Press, 1947.
3. ISAACS, R. P., "Differential Games", J. Wiley Series in Applied Mathematics, Vol. XXV, New York, 1965.
4. FRIEDMAN, A., "Differential Games", J. Wiley Pure and Applied Mathematics, Vol. XXV, New York, 1971.
5. JARMARK, B., "A Realistic Aerial Combat Duel as a Differential Game Study", Proceedings of the IEEE Conf. on Decision and Control, San Antonio, Dec. 14-16, Vol. 2, 682, 1983.
6. SHINAR, J., "Optimum Missile Avoidance and Improved Air Combat Models", Technion Israel Institute of Technology, Haifa, Isreal, AFWAL-TR-81-1115, 1981.
7. BAR-SHALOM, Y., "Tracking Methods in a Multitarget Environment", IEEE Trans. on Automatic Control, Vol. AC-23, 618, 1978.
8. BREAKWELL, J. V., HAGEDORN, P., "Point Capture of Two Evaders in Succession", J. of Optimization Theory and Applications, 27, 89, 1979.
9. BAGCHI, A., BASAR, T., "Team Decision Theory for Linear Continuous Time Systems", IEEE Trans. on Automatic Control, Vol. AC-25, 6, 1154, 1980.
10. HAJEK, O., "Pursuit Games: An Introduction to the Theory and Applications of Differential Games of Pursuit and Evasion", Academic Press, New York, 1975.
11. DOLEZAL, J., "Differential Games with Parameters", 9th IFIP Conf. on Optimization Techniques, Warsaw, Sept. 3-9, 1979.
12. SKOWRONSKI, J. M., "Conjectures on Liapunov Qualitative Games", Int'l J. of Control, 16, 501, 1972.
13. SIMAAN, M., CRUZ, J. B., "Sampled-data Nash Control in Non-zero-sum Differential Games", Int'l J. of Control, 17, 1201, 1973.

14. RAGADE, R. K., SARMA, I. G., "A Note on Controlability, Observability and Sufficient Coordinates in Linear Differential Games", Int'l J. of Control, 10, 331, 1969.
15. HAGEDORN, P., BREAKWELL, J. V., "A Differential Game with Two Pursuers and One Evader", J. of Optimization Theory and Applications, Vol. 18, 15, 1976.
16. FOLEY, M. H., SCHMITENDORF, W. E., "A Class of Differential Games with Two Pursuers Versus One Evader", IEEE Trans. on Automatic Control, Vol. AC-19, 3, 239, 1974.
17. PSHENICHNYI, B. N., CHIKRII, A. A., RAPPOPORT, I. S., "An Efficient Method of Solving Differential Games with Many Pursuers", Soviet Mathematics Doklady, Vol. 23, 104, 1981.
18. PONTRYAGIN, L. S., "Linear Differential Games", SIAM J. Control, Vol. 12, 262, 1974.
19. BRYSON, A. E., HO, Y. C., "Applied Optimal Control", Hemisphere Publishing Corporation, 1975.
20. SATIMOV, M., AZAMOV, A., KHAIDAROV, B. K., "Simple Pursuit of a Fleeing Object by Several Pursuers", Soviet Mathematics Doklady, Vol. 12, 3, 1981.
21. CLEMHAUT, S., WAN, H. Y., "Survey Paper: Interactive Economic Dynamics and Differential Games", J. of Optimization Theory and Applications, Vol. 27, 7, 1979.
22. MOHLER, R. R., KOLODZIEJ, W. J., BUGNON, F. J., "Hierarchical Command, Control and Coupled Bilinear Systems", Proc. 9th IFAC World Congress, Budapest, Hungary, July 2-6, 1984.
23. SIMAAN, M., CRUZ, J. B., "On the Solution of the Open-loop Nash Riccati Equation in Linear Quadratic Differential Games", Int'l J. of Control, Vol. 18, 57, 1973.
24. ICHIKAWA, A., "Linear Quadratic Differential Games in Hilbert Space", SIAM J. Control, Vol. 14, 120, 1976.
25. HAMALAINEN, R. P., "Recursive Algorithms for Nash Strategies in Two Player Difference Games", Int'l J. of Control, Vol. 27, 229, 1978.
26. BEHN, R. D., HO, Y. C., "On a Class of Linear Stochastic Differential Games", IEEE Trans. on Automatic Control, Vol. AC-13, 227, 1968.
27. HO, Y. C., BRYSON, A. E., BARON, S., "Differential Games and Optimal Pursuit-Evasion Strategies", IEEE Trans. on Automatic Control, Vol. AC-10, 385, 1965.

28. HO, Y. C., "Optimal Terminal Maneuver and Evasion Strategy", SIAM J. on Control, Vol. 4, 1966.
29. SPEYER, J. L., "A Stochastic Differential Game with Controllable Statistical Parameters", IEEE Trans. on Systems, Science and Cybernetics, Vol. SSC-3, 1, 17, 1967.
30. GOURISHANKAR, V., SALAMA, A., "A Technique for Solving a Class of Differential Games", Int'l J. of Control Theory, Vol. 15, 529, 1972.
31. LUCE, R. D., RAIFFA, H., "Games and Decisions", Wiley, New York, 1957.
32. FOROUHAR, K., LEONDES, C. T., "Singular Differential Game Numerical Techniques", J. of Optimization Theory and Applications, Vol. 37, 71, 1982.
33. PISARENKO, V. F., "The Retrieval of Harmonics from a Covariance Function", Geophys. J. Roy. Astron. Society, Vol. 33, 247, 1973.
34. BIENVENU, G., KOPP, L., "Optimality of High Resolution Array Processing Using the Eigensystem Approach", IEEE Trans. on Acoustics, Speech and Signal Processing, Vol. ASSP-31, 1235, 1983.
35. RISSANEN, J., "A Universal Prior for the Integers and Estimation by Minimum Description Length", Ann. of Stat., Vol. 11, 417, 1983.
36. WAX, M., KAILATH, T., "Detection of Signals by Information Theoretic Criteria", IEEE Trans. on Acoustics, Speech and Signal Processing, Vol. ASSP-33, 387, 1985.
37. HENDERSON, T. L., "Rank Reduction for Broadband Waves Incident on a Linear Receiving Aperture", Proc. 19th Asilomar Conference on Circ., Systems, Computers, Pacific Grove, CA, 1985.
38. SHAN, T. J., WAX, M., KAILATH, T., "Spatial Smoothing Approach for Location Estimation of Coherent Sources", Proc. 18th Asilomar Conf. on Circ., Syst. and Computers, Pacific Grove, CA, 1984.
39. PAULRAJ, A., KAILATH, T., "Eigenstructures Methods for Direction of Arrival Estimation in the Presence of Unknown Noise Fields", IEEE Trans. on Acoustics, Speech and Signal Processing, Vol. ASSP-34, 13, 1986.