



OREGON 4-H HORSE ADVANCEMENT PROGRAM



4-H 1302R
Revised October 2013

Table of Contents

An Introduction to Oregon 4-H Advancement Programs 1
Using the Horse Advancement Program 3

General Advancements

Level 1

Knowledge Advancements 4
Ground Work Advancements 8
Riding Advancements 9
Personal Development Advancements 10

Level 2

Knowledge Advancements 11
Ground Work Advancements 14
Riding Advancements 15
Personal Development Advancements 16

Level 3

Knowledge Advancements 17
Ground Work Advancements 22
Riding Advancements 23
Personal Development Advancements 24

Specialty Advancements

Trail Advancements

Level 1 25
Level 2 26
Level 3 27

Jumping Advancements

Level 1 28
Level 2 29
Level 3 30

Driving Advancements

Level 1 31
Level 2 32
Level 3 33

Specialty Advancements (contd.)

Gaming Advancements

Level 1	34
Level 2	35
Level 3	36

Ranch Horse Advancements

Working Ranch Horse Advancements

Level 1	37
Level 2	38
Level 3	39

Ranch Horse Trail Advancements

Level 1	40
Level 2	41
Level 3	42

Cow Working Advancements

Level 1	43
Level 2	44
Level 3	45

Roping Advancements

Level 1	46
Level 2	47
Level 3	48

Identification and Skills Advancements

Level 1	49
Level 2	50
Level 3	51

Advancements and Completion Checklist	52
--	-----------

An Introduction to Oregon 4-H Advancement Programs

4-H advancement programs consist of a series of steps that provide a framework for progressive learning within a specific project area. Advancement programs allow 4-H members to move at their own speed and encourage self-learning that is based on members' interests and abilities. Advancement programs are self-paced, age- and skill-level appropriate, and can be a tremendous help to members as they set their goals each year. In addition, advancement programs are useful to Junior Leaders and more experienced 4-H members who wish to work with younger or less-experienced members.

Benefits of 4-H Advancement Programs

Advancement programs:

- Make projects more interesting
- Assist members in setting and achieving goals
- Encourage self-paced learning
- Help members learn more about their projects
- Encourage age-appropriate skill building
- Provide new, enjoyable experiences
- Help prepare members for participation in certain activities and events
- Provide recognition for work well done
- Provide incentive to members to stay in a project over a longer time period

Life Skill Development and 4-H Advancement Programs

Participation in 4-H advancement programs is instrumental in the development of life skills, a major emphasis of 4-H programming. Young people who participate in 4-H are not just gaining knowledge about their project area, they are also developing skills that will be useful throughout their life. Specifically, the 4-H advancement programs are designed to develop life skills in:

- Learning to learn
- Making decisions
- Keeping records
- Planning and organizing
- Achieving goals
- Completing a project or task
- Communicating
- Being responsible
- Developing self-esteem

Recording Progress in the Advancement Program

Leaders should encourage members to keep the advancement program with their records. Doing so allows leaders and members to evaluate the 4-H experience, review progress, and

establish goals for the future. Upon completing an element, the 4-H member fills in the date and the leader initials the record. Upon completing all the elements of an advancement area, the leader (or other knowledgeable expert) signs and dates the advancement record and initials the advancement completion checklist.

Recognizing Advancement

The National 4-H Recognition Model outlines five different ways in which 4-H members can be recognized.

1. Participation

This type of recognition program emphasizes the importance of acknowledging young people who have been involved in 4-H educational experiences. For some youth, participation in a 4-H learning experience is an accomplishment.

2. Progress toward self-set goals

Parents and other adults can help youth set realistic goals. Recognition for progress toward self-set goals, no matter how small, is an integral part of this type of recognition.

3. Achievement of standards of excellence

Experts in a given area establish standards of excellence. By measuring personal progress against standards of excellence, youth can gain insight into their own efforts and abilities.

4. Peer competition

Peer competition subjectively identifies, in a concrete time and place, the best team or individual. Peer competition is a strong motivator for some youth but is inappropriate for youth under age 8.

5. Cooperation

Learning and working together promotes high achievement. Cooperation takes advantage of all the skills represented in the group and the process the group uses to approach a learning task or goal. Through cooperation, everyone is rewarded.

Advancement Certificates

The 4-H Advancement Program is an excellent way to promote and recognize members' efforts in progressing toward self-set goals and achieving standards of excellence through learning. Advancement certificates that are customized for each project area are available from your county Extension office. Contact a county 4-H staff member to request advancement certificates in your project area.

Earning an advancement certificate deserves recognition. When members have completed a level of advancement, it should be recognized. This can be done at an achievement meeting or other community event. Extension 4-H staff members can also help leaders prepare newspaper and radio press releases about members' achievements.

Using the Horse Advancement Program

Advancement programs are written to provide a learning sequence for all members. While youth will progress at different rates through the various steps, it is important that members are continually advancing with their project. To that end, members should complete steps every year.

Much of the information leaders and members need to complete advancement steps can be found in the horse project manuals. In some advanced steps, members will need to refer to other sources.

A knowledgeable person should sign horse advancements. This person may be different for different areas. For example, a club leader or parent may not have the expertise needed to sign advancements for driving, jumping, or cow working. 4-H members should find a person with expertise in the area they are working on to check their advancements.

Many of the horse advancement steps are included for safety reasons. 4-H is committed to teaching its members how to safely handle, ride, and show their animals. 4-H also wants to ensure the safety of others, whether at a club riding meeting or a county fair.

Therefore, to meet youth development goals and safety considerations, the following guidelines are in effect:

Mandatory

- To compete at a county fair in showmanship, members must first complete the Level 1 Ground Work Advancements.
- To compete at a county fair in any riding class, members must first complete the Level 1 Riding Advancements.
- To compete at a county fair in any specialty advancement area (such as jumping or gaming) or any ranch horse advancement area (such as roping or cow working), members must first complete the Level 1 Advancements for that specific area.
- Dad Potter: Before attempting any three-step Dad Potter Certificate of Merit, members must first complete their three selected Dad Potter steps in the Riding Advancements. Members must complete all 10 Dad Potter elements specified in the Riding Advancements before participating in a Dad Potter trial.

Recommended

- By the end of their junior years (usually 6th grade), members should have completed the Level 1 Knowledge, Ground Work, and Riding Advancements.
- By the end of their intermediate years (usually 9th grade), members should have completed the Level 2 Knowledge, Ground Work, and Riding Advancements.
- By the end of their senior years (usually 12th grade), members should have completed the Level 3 Knowledge, Ground Work, and Riding Advancements.
- For showing in specialty advancement areas, intermediate members should have completed Level 2 Advancements in those areas and senior members should have completed Level 3 Advancements in those areas.
- All members should complete at least two personal development options each year.

1 KNOWLEDGE ADVANCEMENTS

1. In the table below, list three different horse breeds and the following information about them.

Breed:			
Origin:			
Characteristics:			
Primary uses:			

2. What are the five basic coat colors? Name and briefly describe them.

- 1.
- 2.
- 3.
- 4.
- 5.

3. What are the five major variations to the basic coat colors? Name and briefly describe them.

- 1.
- 2.
- 3.
- 4.
- 5.

4. On the pictures below, draw the following face markings: star, stripe, blaze, snip, and bald face.

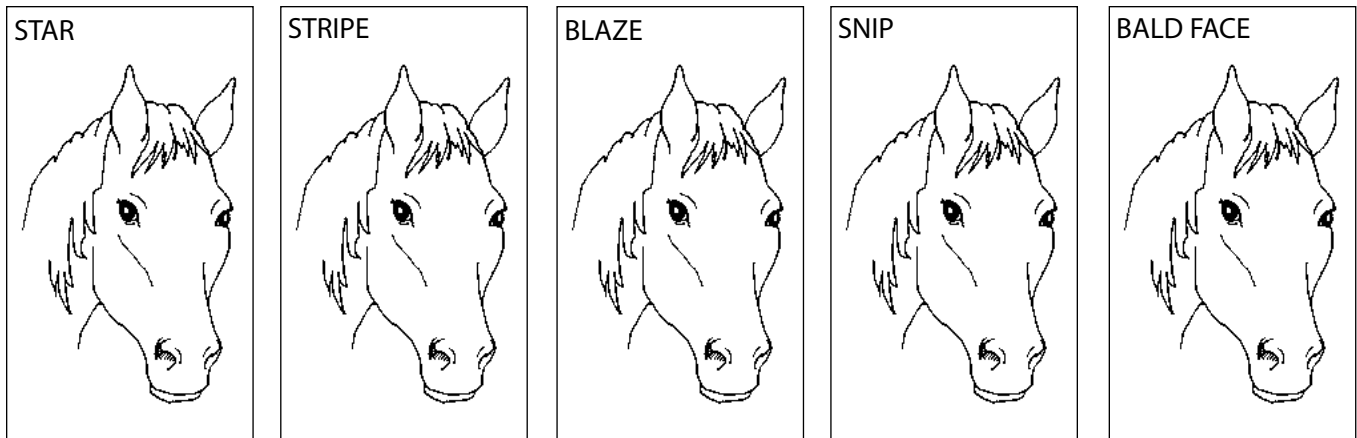

KNOWLEDGE ADVANCEMENTS (contd.)

5. Identify the following parts of the hunt seat saddle.
Write their names in the boxes.

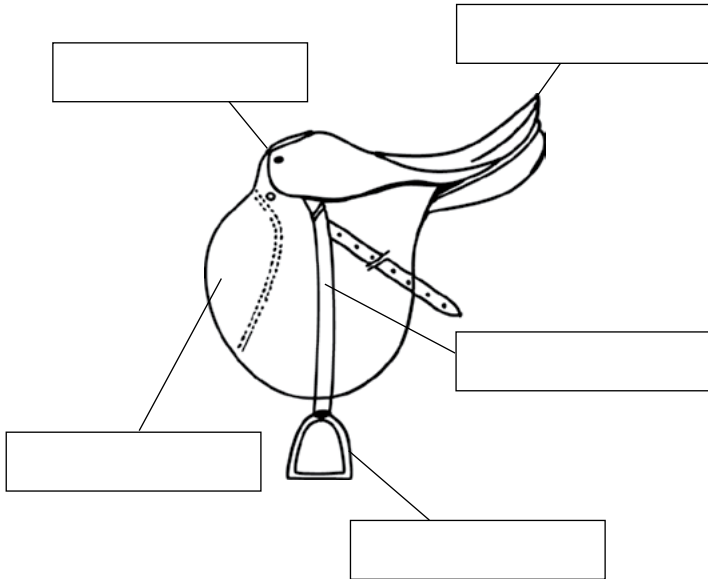

6. Identify the following parts of the English bridle.
Write their names in the boxes.

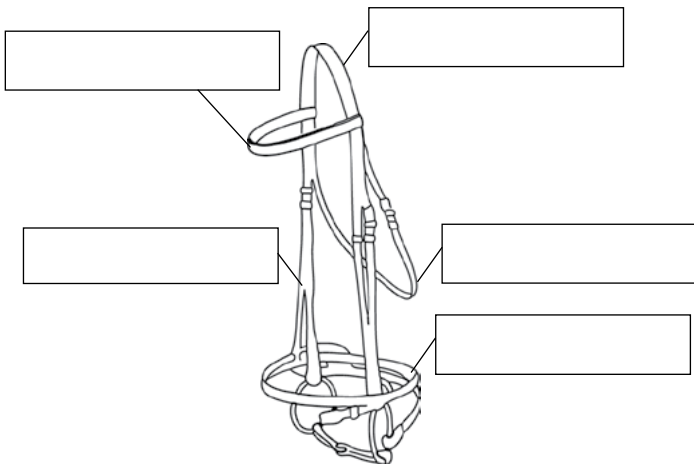

7. Number the order in which you would use the following grooming tools, with "1" as the first tool and "6" as the last.

- ___ Body brush
- ___ Mane and tail comb
- ___ Dandy brush
- ___ Cloth
- ___ Curry comb
- ___ Hoof pick

8. List three reasons why grooming is beneficial to your horse's health.

- 1.
- 2.
- 3.

9. Below are statements regarding catching and/or approaching a horse. Indicate whether the statements are true ("T") or false ("F").

- ___ When possible, approach the horse at an angle and come in near its shoulder.
- ___ Most horses are likely to jump and/or kick if they are startled.
- ___ If it is necessary to approach the horse from the rear, you should not speak to the horse to avoid startling it.
- ___ When behind the horse, you should stay close to its body.
- ___ You should use grain to catch a horse, even if other horses are present.

KNOWLEDGE ADVANCEMENTS (contd.)

10. Match the following terms (on the left) to their definitions (on the right). Draw a line from the term to its definition.

- | | |
|-------------|-------------------------------------|
| A. Filly | 1. An unweaned horse |
| B. Mare | 2. A male horse that is castrated |
| C. Colt | 3. Female horse under age 3 |
| D. Foal | 4. A mature female, age 3 or older |
| E. Gelding | 5. A male horse able to sire a foal |
| F. Stallion | 6. Male horse under age 3 |

11. Name five items that you should take with you when you go on a trail ride.

- 1.
- 2.
- 3.
- 4.
- 5.

12. Identify the following parts of the western saddle. Write their names in the boxes.

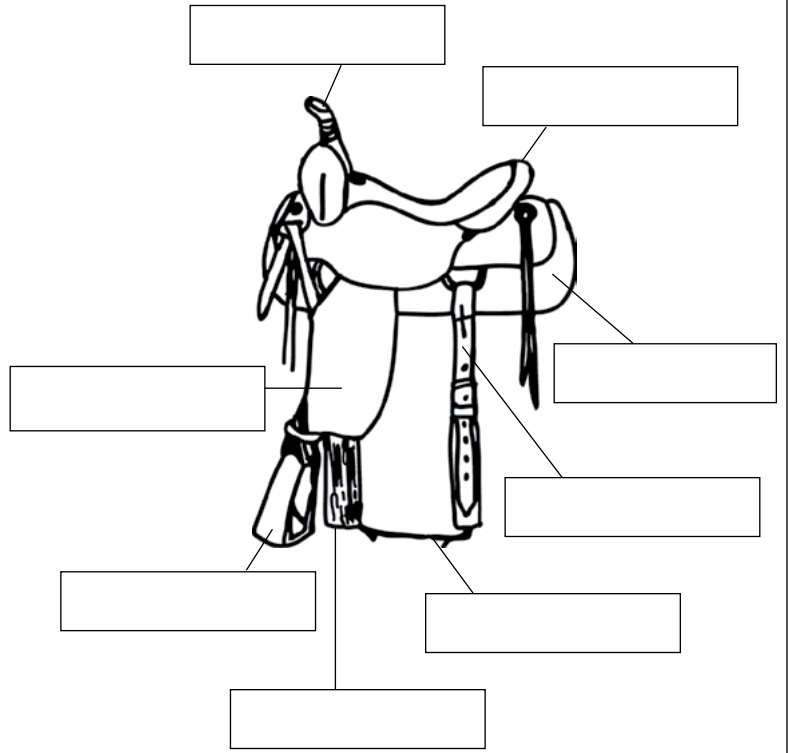

13. Identify the following parts of the western bridle. Write their names in the boxes.

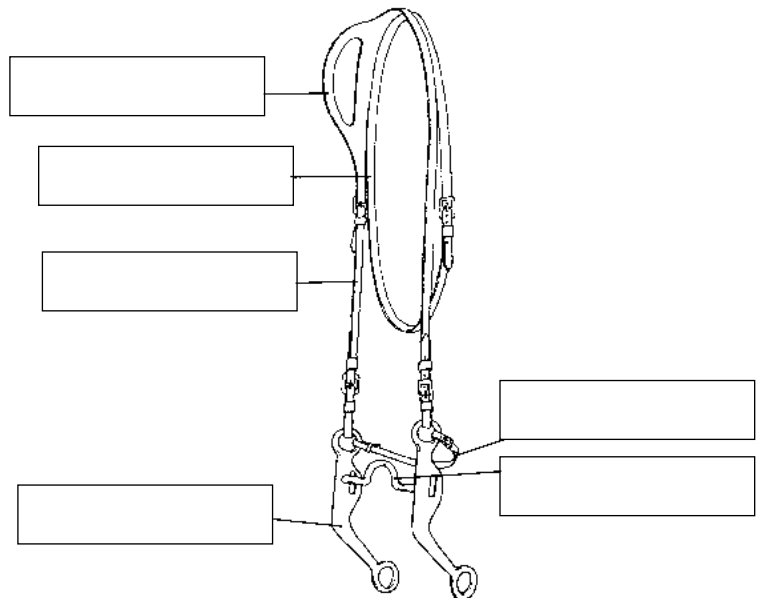

1 KNOWLEDGE ADVANCEMENTS (contd.)

14. On the pictures below, draw the following leg markings: coronet, pastern, ankle, sock (half-stocking), stocking, and full stocking.

CORONET

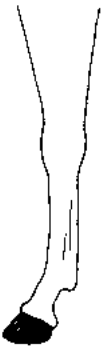

PASTERN

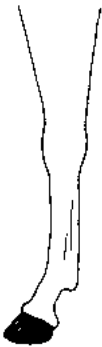

ANKLE



SOCK



STOCKING



FULL STOCKING



15. On the picture below, draw a line indicating where you would measure the horse's height.

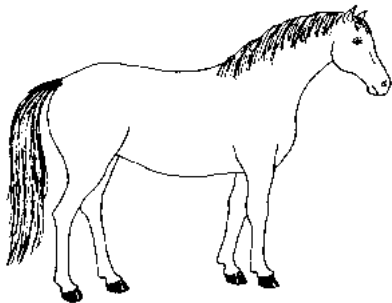

16. Match the following gaits (on the left) to their descriptions (on the right). Draw a line from the gait to its description.

- | | |
|-----------------|--|
| A. Walk | 1. Western term for slow trot |
| B. Sitting trot | 2. Western term for the three-beat gait |
| C. Posting trot | 3. English term for free-moving, two-beat gait |
| D. Canter | 4. Four-beat gait |
| E. Jog | 5. English term for smooth, three-beat gait |
| F. Lope | 6. English term for a two-beat gait slower than a posting trot |

17. Identify the following parts of the horse. Write their names in the boxes.

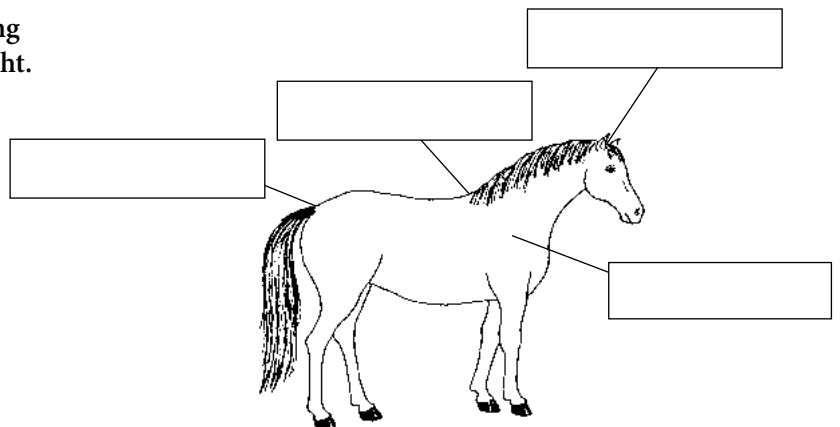

Congratulations! You have successfully completed Level 1 of the Knowledge Advancements!

<p>_____</p> <p style="text-align: center;"><i>Name of Club Member</i></p>	<p>has satisfactorily completed all of the above knowledge elements and has, therefore, completed Level 1 of the Oregon 4-H Knowledge Advancements.</p>
<p>Leader's Signature: _____</p>	<p>Date Approved: _____</p>

GROUND WORK ADVANCEMENTS

1. Ask your club leader to watch you perform the following ground work elements and sign off that you perform them accurately and safely.

Element	Date Completed	Leader's Initials
Demonstrate proper quartering		
Pose your horse (as in showmanship)		
Back from the ground the requested number of steps		
Halter your horse (showing proper halter adjustment)		
Tie your horse with a quick-release knot		
Properly brush your horse		
Lead your horse at a walk and trot from the near side		
Perform a 90-degree haunch turn (both directions)		
Demonstrate how to properly approach and catch your horse		
Show how to properly attach a chain over the nose and under the chin		

2. What is the purpose of showmanship in 4-H?

3. If a chain is used in showmanship, approximately how long should it be?

_____ inches

4. What are the five areas of the horse you should clip for a show?

- 1.
- 2.
- 3.
- 4.
- 5.

Congratulations! You have successfully completed Level 1 of the Ground Work Advancements!

_____ has satisfactorily completed all of the above ground work elements and has, therefore, completed Level 1 of the Oregon 4-H Ground Work Advancements.

Name of Club Member

Leader's Signature: _____ Date Approved: _____

1 RIDING ADVANCEMENTS

1. Ask your club leader to watch you perform the following riding elements and sign off that you perform them accurately and safely.

Element	Date Completed	Leader's Initials
Mount your horse from the near side		
Dismount your horse from the near side		
Perform a serpentine at a walk and trot		
Canter/lope on the rail (both directions)		
Halt from a walk, trot, and canter/lope		
Perform a series of figure 8s at the trot, changing diagonals		
Perform a series of figure 8s at the canter/lope, executing a simple change of lead		
Perform a 180-degree haunch turn (both directions)		
Perform a 180-degree forehand turn (both directions)		
Perform a posting trot on a straightaway and change diagonals three times as requested by your leader (Dad Potter Step #7)		
Walk forward and backward the exact number of steps requested (Dad Potter Step #1)		

2. Describe one way to cue a horse to stop.

3. Describe one way to make a horse trot.

4. What are three aids (natural or artificial) that you might use when riding your horse?

- 1.
- 2.
- 3.

5. What are three things you should consider when choosing a riding instructor?

- 1.
- 2.
- 3.

Congratulations! You have successfully completed Level 1 of the Riding Advancements!

_____ has satisfactorily completed all of the above riding elements and has, therefore, completed Level 1 of the Oregon 4-H Riding Advancements.

Name of Club Member

Leader's Signature: _____ Date Approved: _____

PERSONAL DEVELOPMENT ADVANCEMENTS

Members should complete at least two personal development options each year. Indicate the personal development options that you complete and ask your leader to sign off that you have completed them.

Option	Date Completed	Leader's Signature
Lead the Pledge of Allegiance and the 4-H pledge at a club meeting	_____	_____
Observe a horse being shod	_____	_____
Visit a tack store	_____	_____
Read a horse book	_____	_____
Attend a 4-H camp	_____	_____
Serve as host for a 4-H meeting	_____	_____
Give a presentation	_____	_____
Create an educational display	_____	_____
Participate in a judging contest	_____	_____
Participate in a hippology contest	_____	_____
Participate in a horse bowl contest	_____	_____
Participate in your county fair	_____	_____
Participate in a community service project	_____	_____
Conduct a horse-related science inquiry	_____	_____
Other: _____	_____	_____
Other: _____	_____	_____
Other: _____	_____	_____

Congratulations! You have successfully completed Level 1 of the Personal Development Advancements!

_____ has satisfactorily performed the required amount of personal development options listed above and has, therefore, completed Level 1 of the Oregon 4-H Personal Development Advancements.

Name of Club Member

Leader's Signature: _____ Date Approved: _____

1. What are five signs of a normal, healthy horse?

- 1.
- 2.
- 3.
- 4.
- 5.

2. Name five diseases that you can (and should) vaccinate your horse for.

- 1.
- 2.
- 3.
- 4.
- 5.

3. Match the following internal parasites (on the left) to their descriptions (on the right). Draw a line from the parasite to its description.

- | | |
|---------------------|---------------------------|
| A. Large strongyles | 1. Least harmful |
| B. Ascarids | 2. Largest |
| C. Pinworms | 3. Most harmful |
| D. Tapeworms | 4. Larvae of bot fly |
| E. Bots | 5. Require immediate host |

4. What are three ways to control internal parasites?

- 1.
- 2.
- 3.

5. Name three external parasites and list one control method for each of them.

Parasite	Control Method

6. What are the six essential nutrients?

- 1.
- 2.
- 3.
- 4.
- 5.
- 6.

2 KNOWLEDGE ADVANCEMENTS (contd.)

7. List the three types of hunt seat saddles and a feature of each one.

- 1.
- 2.
- 3.

8. Below are various examples of aids that you might use when riding your horse. In the space provided, write an “N” if the aid is a natural aid or an “A” if it is an artificial aid.

- _____ Hands
- _____ Crop
- _____ Legs
- _____ Weight
- _____ Spurs
- _____ Voice

9. How long is a horse’s gestation period?

10. What is the name of the concentrated milk that a dam secretes for the first few days after giving birth?

11. Below are various qualities of hay. Circle the qualities that are good for hay to have. Cross out the qualities that are bad for hay to have.

- Cut when mature
- Green
- Low leaf-to-stem ratio
- Sweet smelling
- Free of weeds, dust, and dirt
- Moldy

12. What are the two categories of hay?

- 1.
- 2.

13. Name two types of legumes.

- 1.
- 2.

14. Name three types of grass hay.

- 1.
- 2.
- 3.

15. Identify the following parts of the curb bit. Write their names below.

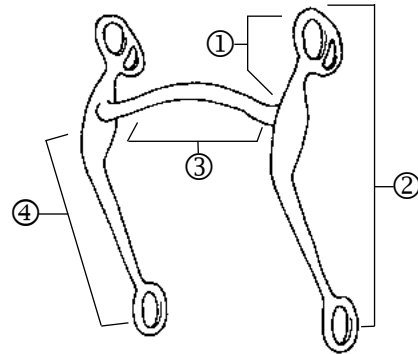

- ① _____
- ② _____
- ③ _____
- ④ _____

2 KNOWLEDGE ADVANCEMENTS (contd.)

16. Name and briefly describe the three types of lead changes.

- 1.
- 2.
- 3.

17. What are five items you should have in your equine first aid kit?

- 1.
- 2.
- 3.
- 4.
- 5.

18. What are five factors you should consider when looking to buy a horse?

- 1.
- 2.
- 3.
- 4.
- 5.

19. What is a horse's normal temperature?

_____ degrees Fahrenheit

20. What is a horse's normal standing pulse?

_____ beats/minute

21. What is a horse's normal standing respiration rate?

_____ breaths/minute

22. What are two benefits of controlling your horse's grazing?

- 1.
- 2.

23. Briefly describe how you should store the following items of tack.

1. Bridle:
2. Saddle:
3. Blanket:

24. What is the definition of a stable vice?

Congratulations! You have successfully completed Level 2 of the Knowledge Advancements!

_____ has satisfactorily completed all of the above knowledge elements and has, therefore, completed Level 2 of the Oregon 4-H Knowledge Advancements.

Name of Club Member

Leader's Signature: _____ Date Approved: _____

2 GROUND WORK ADVANCEMENTS

1. Ask your club leader to watch you perform the following ground work elements and sign off that you perform them accurately and safely.

Element	Date Completed	Leader's Initials
Tie a bowline knot		
Pick up and clean front and back hooves		
Saddle your horse		
Bridle your horse		
Unsaddle your horse		
Unbridle your horse		
Perform a 180-degree haunch turn (both directions)		
Perform a 180-degree forehand turn (both directions)		
Lead your horse from the off side at a walk		

2. What are two benefits of longeing your horse?

- 1.
- 2.

3. Why is it important that your horse learns to stand still while you pick up its feet?

4. Describe how to safely load a horse in a trailer.

5. How long should a lead rope be for showing?

_____ feet

6. Describe how to safely cross-tie a horse.

Congratulations! You have successfully completed Level 2 of the Ground Work Advancements!

_____ has satisfactorily completed all of the above ground work elements and has, therefore, completed Level 2 of the Oregon 4-H Ground Work Advancements.

Name of Club Member

Leader's Signature: _____ Date Approved: _____

2 RIDING ADVANCEMENTS

1. Ask your club leader to watch you perform the following riding elements and sign off that you perform them accurately and safely.

Element	Date Completed	Leader's Initials
Mount your horse from the off side		
Dismount your horse from the off side		
Pick up a canter/lope from walk (both leads)		
Pick up a canter/lope from trot (both leads)		
Perform an extended jog/trot		
Sidepass at least 12 steps (both directions) with the forefeet completely crossing over (Dad Potter Step #2)		
Stand still for 10 seconds		
Perform a 360-degree haunch turn (both directions), keeping the pivot foot in a 3-foot circle and maintaining forward motion (Dad Potter Step #4)		
Perform a 360-degree forehand turn (both directions), keeping the pivot foot in a 2-foot circle and maintaining forward motion (Dad Potter Step #3)		
Demonstrate proper body and leg position at all gaits		
Demonstrate how to properly hold split reins and romal reins		

2. Name three general safety rules that 4-H members should observe when riding their horses.

- 1.
- 2.
- 3.

3. Name three safety rules that 4-H members should observe when riding on the trail.

- 1.
- 2.
- 3.

Congratulations! You have successfully completed Level 2 of the Riding Advancements!

_____ has satisfactorily completed all of the above riding elements and has, therefore, completed Level 2 of the Oregon 4-H Riding Advancements.

Name of Club Member

Leader's Signature: _____ Date Approved: _____

2 PERSONAL DEVELOPMENT ADVANCEMENTS

Members should complete at least two personal development options each year. Indicate the personal development options that you complete and ask your leader to sign off that you have completed them.

Option	Date Completed	Leader's Signature
Lead the pledges at a 4-H event	_____	_____
Visit a horse training or breeding facility	_____	_____
Visit a large, open horse show	_____	_____
Serve as a Junior Leader	_____	_____
Make arrangements for a tour for your club	_____	_____
Secure a speaker to talk at a club meeting	_____	_____
Lead an activity at a club meeting	_____	_____
Attend a state 4-H event	_____	_____
Give a presentation	_____	_____
Create an educational display	_____	_____
Participate in a judging contest	_____	_____
Participate in a hippology contest	_____	_____
Participate in a horse bowl contest	_____	_____
Participate in your county fair	_____	_____
Participate in a community service project	_____	_____
Conduct a horse-related science inquiry	_____	_____
Other: _____	_____	_____
Other: _____	_____	_____
Other: _____	_____	_____

Congratulations! You have successfully completed Level 2 of the Personal Development Advancements!

_____ has satisfactorily performed the required amount of personal development options listed above and has, therefore, completed Level 2 of the Oregon 4-H Personal Development Advancements.

Name of Club Member

Leader's Signature: _____ Date Approved: _____

3 KNOWLEDGE ADVANCEMENTS

1. Match the following grains (on the left) with their descriptions (on the right). Draw a line from the grain to its description.

- | | |
|-----------|--|
| A. Oats | 1. Susceptible to ergot fungus |
| B. Barley | 2. Easy to digest; soft and easy to roll |
| C. Corn | 3. Must be fed crimped or rolled |
| D. Wheat | 4. Can be lethal when moldy |
| E. Rye | 5. High in energy; expensive |

2. Name three common protein supplements.

- 1.
- 2.
- 3.

3. Name three common fat supplements.

- 1.
- 2.
- 3.

4. When should you add a supplement to your horse's diet?

5. What are three things that you should do to ensure your horse stays healthy when the weather is cold?

- 1.
- 2.
- 3.

6. What are four health problems that are common during the hotter months of the year?

- 1.
- 2.
- 3.
- 4.

7. What are three ways that you can prevent heat-related health problems?

- 1.
- 2.
- 3.

8. Below are scenarios that depict health issues your horse may experience. Write a "Y" if you should call a veterinarian in the situation; write an "N" if you should not call a veterinarian.

- _____ Your horse has a temperature of 101 degrees Fahrenheit.
- _____ Your horse has a deep puncture wound.
- _____ Your horse appears to have a broken bone.
- _____ Your horse appears to be limping a bit.
- _____ Your horse has persistent diarrhea.
- _____ Your horse has a wound that appears to be infected.

9. Identify the following parts of the hoof. Write their names in the boxes.

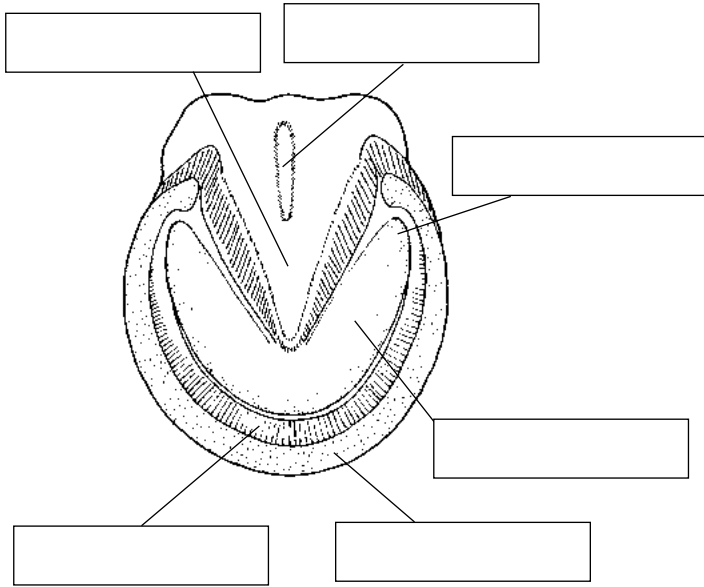

10. Match the following unsoundnesses and/or conformation faults (on the left) to their definitions (on the right). Draw a line from the conformation fault/unsoundness to its definition.

- | | |
|----------------|---|
| A. Bone spavin | 1. Depression of the muscle mass in the shoulder caused by an injury to a nerve |
| B. Bog spavin | 2. Puffy condition in the hollow of the hock |
| C. Thoroughpin | 3. Soft filling of the natural depression on the inside and front of the hock |
| D. Calf-knees | 4. Knees that protrude too far forward when viewed from the side |
| E. Buck-knees | 5. Knees that break backward when viewed from the side |
| F. Sweeney | 6. Bony enlargement on the inside and front of the hock |

11. How many permanent teeth do adult male horses have?

12. How many permanent teeth do adult female horses have?

13. Put the following teeth in order from youngest to oldest. Write the order in the space provided below.

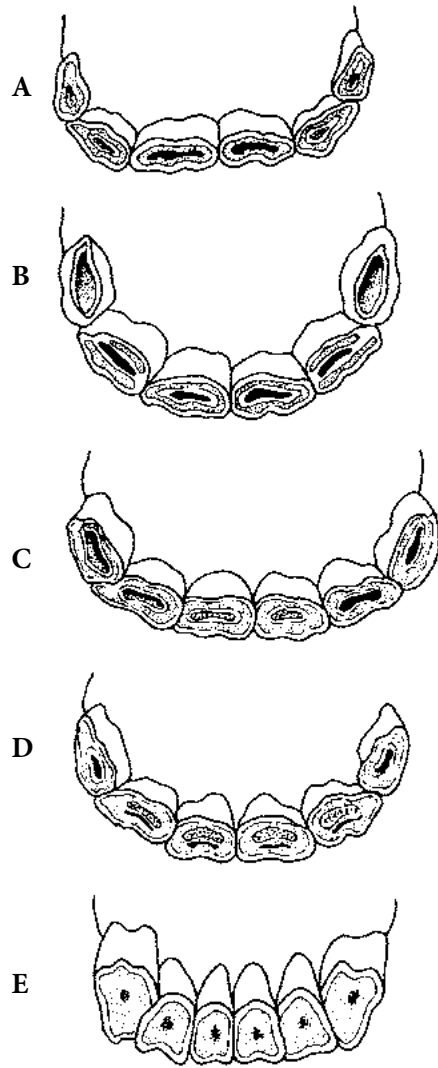

14. What are two ways that you can test to see if your horse is dehydrated?

- 1.
- 2.

15. Briefly describe the following stable vices.

Cribbing:

Wood chewing:

Weaving:

Stall walking:

16. What are five things that you can do to prevent a fire in your barn?

- 1.
- 2.
- 3.
- 4.
- 5.

17. Below are four things you should do if a fire ever breaks out in your barn. Number them in order, with "1" as the first thing you should do and "4" as the last.

- _____ Open one door of the stable.
- _____ Save equipment from the stable (if it is safe to go in the barn).
- _____ Lead the horses out of the stable (if it is safe to go in the barn).
- _____ Call the fire department.

18. Rate the following plants on their level of toxicity to horses. Use the following ranking system: 5 = very high toxicity, 4 = high toxicity, 3 = moderate toxicity, 2 = low toxicity, and 1 = no toxicity.

- _____ Chokecherry
- _____ Nightshade
- _____ Yew
- _____ Foxglove
- _____ Bracken fern
- _____ Water hemlock
- _____ Elderberry

3 KNOWLEDGE ADVANCEMENTS (contd.)

19. Below are various diseases. Circle the diseases that currently have a cure.

- West Nile virus
- Equine encephalomyelitis
- Rabies
- Tetanus
- Equine infectious anemia
- Equine influenza
- Potomac horse fever
- Strangles

20. Match the following diseases (on the left) to their descriptions (on the right). Draw a line from the disease to its description.

- | | |
|--------------|--|
| A. Tetanus | 1. Contagious upper respiratory disease |
| B. Strangles | 2. Caused by protozoa found in opossums |
| C. Influenza | 3. Serious disease; also called "lockjaw" |
| D. Rabies | 4. Mosquito-borne virus; causes encephalitis |
| E. EPM | 5. Common viral respiratory disease |
| F. EIA | 6. Seasonal disease; occurs mostly in summer |
| G. PHF | 7. Rare disease; 100% fatal |
| H. West Nile | 8. Also called "swamp fever;" no vaccine to prevent it |

21. Identify the following parts of the horse's skeleton. Write their names below.

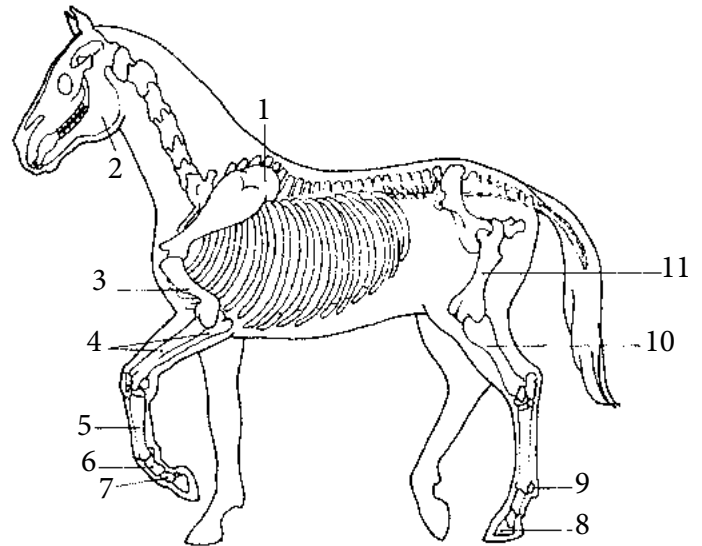

1. _____
2. _____
3. _____
4. _____
5. _____
6. _____
7. _____
8. _____
9. _____
10. _____
11. _____

KNOWLEDGE ADVANCEMENTS (contd.)

22. Briefly describe the following common hoof problems.

Thrush:

White line disease:

Sand cracks:

Laminitis:

Navicular disease:

23. Name the following boots and give an example of when you would use each type.

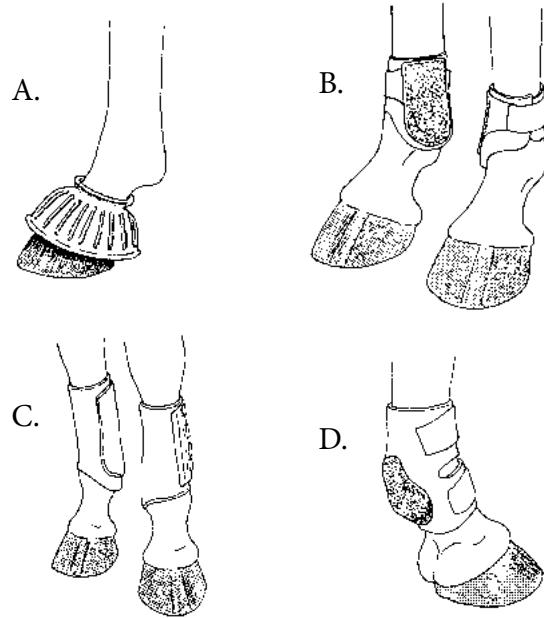

A. Name: _____

Use: _____

B. Name: _____

Use: _____

C. Name: _____

Use: _____

D. Name: _____

Use: _____

Congratulations! You have successfully completed Level 3 of the Knowledge Advancements!

Name of Club Member

has satisfactorily completed all of the above knowledge elements and has, therefore, completed Level 3 of the Oregon 4-H Knowledge Advancements.

Leader's Signature: _____

Date Approved: _____

3 GROUND WORK ADVANCEMENTS

1. Explain how you can tell whether a horse's halter is correctly adjusted and why an incorrectly adjusted halter is unsafe.

2. Describe the proper position for a longe whip at the following gaits while longeing your horse:

1. Walk:
2. Trot:
3. Canter:

3. Why should you not use a lead rope to longe a colt?

4. Ask your club leader to watch you perform the following ground work elements and sign off that you perform them accurately and safely.

Element	Date Completed	Leader's Initials
Sidepass the correct number of steps (both directions)		
Perform a 360-degree forehand turn (both directions)		
Perform a 360-degree haunch turn (both directions)		
Lead your horse from the off side at a trot		
Back your horse around a cone		
Work horse at all gaits on the longe line		
Clip your horse		

Congratulations! You have successfully completed Level 3 of the Ground Work Advancements!

_____ has satisfactorily completed all of the above ground work elements and has, therefore, completed Level 3 of the Oregon 4-H Ground Work Advancements.

Name of Club Member

Leader's Signature: _____ Date Approved: _____

3 RIDING ADVANCEMENTS

1. Describe what is meant by the term “light hand” and why a light hand is beneficial to the horse.

2. Ask your club leader to watch you perform the following riding elements and sign off that you perform them accurately and safely.

Element	Date Completed	Leader's Initials
Pick up a jog/trot from a standing position (Dad Potter Step #6)		
Pick up a canter/lope from halt (both leads)		
Perform a figure 8 at a canter/lope, executing an interrupted change of lead (Dad Potter Step #8)		
Perform an interrupted change of lead on a straight line		
Perform a figure 8 at a canter/lope, executing a flying change of lead		
Perform two flying lead changes on a straight line (Dad Potter Step #10)		
Hand gallop (both directions)		
Perform a figure 8, executing a flying lead change, then continue on to 2 circles to the left/right, another lead change, then 2 circles in the other direction (Dad Potter Step #6)		
Two track (both directions) (Dad Potter Step #5)		
Demonstrate collection at all gaits		

Congratulations! You have successfully completed Level 3 of the Riding Advancements!

_____ has satisfactorily completed all of the above riding elements and
Name of Club Member has, therefore, completed Level 3 of the Oregon 4-H Riding Advancements.

Leader's Signature: _____ Date Approved: _____

3 PERSONAL DEVELOPMENT ADVANCEMENTS

Members should complete at least two personal development options each year. Indicate the personal development options that you complete and ask your leader to sign off that you have completed them.

Option	Date Completed	Leader's Signature
Serve as a club officer	_____	_____
Serve as a teen leader	_____	_____
Be a teen counselor at a 4-H camp	_____	_____
Serve on a state planning committee	_____	_____
Serve as teen staff at State Fair	_____	_____
Write a news story for a local newspaper	_____	_____
Discuss preventative medicine with a veterinarian	_____	_____
Have a feed, soil, or fecal sample analyzed	_____	_____
Make an emergency plan for your barn	_____	_____
Conduct a safety inspection of your stall/barn	_____	_____
Interview a professional in a horse career	_____	_____
Give a presentation	_____	_____
Create an educational display	_____	_____
Participate in a judging contest	_____	_____
Participate in a hippology contest	_____	_____
Participate in a horse bowl contest	_____	_____
Participate in your county fair	_____	_____
Participate in a community service project	_____	_____
Conduct a horse-related science inquiry	_____	_____
Other: _____	_____	_____
Other: _____	_____	_____
Other: _____	_____	_____

Congratulations! You have successfully completed Level 3 of the Personal Development Advancements!

_____ <i>Name of Club Member</i>	has satisfactorily performed the required amount of personal development options listed above and has, therefore, completed Level 3 of the Oregon 4-H Personal Development Advancements.
Leader's Signature: _____	Date Approved: _____

1 TRAIL ADVANCEMENTS

1. Name five obstacles that are common in a trail class.

- 1.
- 2.
- 3.
- 4.
- 5.

2. Name three movements you might be asked to perform in a trail class.

- 1.
- 2.
- 3.

3. Name three things that a horse is judged on in a trail class.

- 1.
- 2.
- 3.

4. Name three movements your horse should be able to perform before you attempt to execute a trail course.

- 1.
- 2.
- 3.

Ask your club leader or a trail expert to watch you perform the following trail elements (while mounted) and sign off that you perform them accurately and safely.		
Element	Date Completed	Leader's Signature
1. Walk over poles		
2. Trot over poles		
3. Back between two poles		
4. Jog a serpentine around cones		
5. Walk over a bridge		

Congratulations! You have successfully completed Level 1 of the Trail Advancements!

_____ has satisfactorily completed all of the above trail elements and
Name of Club Member has, therefore, completed Level 1 of the Oregon 4-H Trail Advancements.

Leader's Signature: _____ Date Approved: _____

2 TRAIL ADVANCEMENTS

1. Describe what you should do if you get lost or separated from your group while on a trail ride.

3. Name three things that would be considered a major fault in a trail class.

- 1.
- 2.
- 3.

2. Describe when you would use the following knots on a trail ride.

Bowline: _____

Quick-release: _____

4. When backing through an “L,” what are the three steps you and your horse must perform?

- 1.
- 2.
- 3.

Ask your club leader or a trail expert to watch you perform the following trail elements (while mounted) and sign off that you perform them accurately and safely.		
Element	Date Completed	Leader’s Signature
1. Open and close a gate		
2. Sidepass pole (both directions)		
3. Back through “L”		
4. Trot over elevated poles		
5. Open and close a mailbox		

Congratulations! You have successfully completed Level 2 of the Trail Advancements!

_____ has satisfactorily completed all of the above trail elements and
Name of Club Member has, therefore, completed Level 2 of the Oregon 4-H Trail Advancements.

Leader’s Signature: _____ Date Approved: _____

3 TRAIL ADVANCEMENTS

1. Name the five things that would be defined as “off course” in a trail class.

- 1.
- 2.
- 3.
- 4.
- 5.

2. Name and describe four common ways to secure horses at camp on a trail ride.

- 1.
- 2.
- 3.
- 4.

Ask your club leader or a trail expert to watch you perform the following trail elements (while mounted) and sign off that you perform them accurately and safely.		
Element	Date Completed	Leader’s Signature
1. Put on a slicker		
2. Sidepass “L” (both directions)		
3. Back around barrels		
4. Lope over poles		
5. Perform a haunch turn in a box		
6. Perform a forehand turn in a box		
7. Carry an item while mounted		

Congratulations! You have successfully completed Level 3 of the Trail Advancements!

_____ has satisfactorily completed all of the above trail elements and
Name of Club Member has, therefore, completed Level 3 of the Oregon 4-H Trail Advancements.

Leader’s Signature: _____ Date Approved: _____

1

JUMPING ADVANCEMENTS

1. Name three things that would disqualify a rider from a Hunt Seat Equitation Over Fences class.

- 1.
- 2.
- 3.

3. Describe where to look when you are going over a jump.

2. Name five jumps that could be used in a 4-H jumping course.

- 1.
- 2.
- 3.
- 4.
- 5.

4. Name three types of saddles that are recommended for jumping.

- 1.
- 2.
- 3.

Ask your club leader or a jumping expert to watch you perform the following jumping elements and sign off that you perform them accurately and safely.

Element	Date Completed	Leader's Signature
1. Properly saddle, bridle, and adjust all tack for correct fit		
2. Show calm control of the horse at all gaits		
3. Demonstrate how to open your stirrup bars for use in jumping		
4. Two-point at all three gaits		
5. Crest release while doing cavaletti work in proper jump position		

Congratulations! You have successfully completed Level 1 of the Jumping Advancements!

_____ has satisfactorily completed all of the above jumping elements and has, therefore, completed Level 1 of the Oregon 4-H Jumping Advancements.

Name of Club Member

Leader's Signature: _____ Date Approved: _____

2 JUMPING ADVANCEMENTS

1. Name three types of bits that are allowed in jumping classes.

- 1.
- 2.
- 3.

3. What three things does caveletti work teach your horse?

- 1.
- 2.
- 3.

2. Name five jumps that are prohibited in 4-H jumping courses.

- 1.
- 2.
- 3.
- 4.
- 5.

4. What are the four parts of a jump?

- 1.
- 2.
- 3.
- 4.

Ask your club leader or a jumping expert to watch you perform the following jumping elements and sign off that you perform them accurately and safely.		
Element	Date Completed	Leader's Signature
1. Safely halt out of a hand gallop; no movement after stopping		
2. Perform leg-yields at the collected trot and extended trot		
3. Trot in jump position over a single jump (15–18 inches)		
4. Trot over a series of low jumps (18–24 inches)		
5. Jump a low (20–24 inches) 24-foot in-and-out at the canter		

Congratulations! You have successfully completed Level 2 of the Jumping Advancements!

_____ has satisfactorily completed all of the above jumping elements and has, therefore, completed Level 2 of the Oregon 4-H Jumping Advancements.

Name of Club Member

Leader's Signature: _____ Date Approved: _____

3 JUMPING ADVANCEMENTS

1. Name three ways to add variation to jumps when practicing.

- 1.
- 2.
- 3.

3. Describe how to correct a horse that jumps too soon or too close to a jump.

2. Describe how to prevent your legs from swinging while going over jumps.

4. What are four common mistakes that lead to horses refusing jumps?

- 1.
- 2.
- 3.
- 4.

Ask your club leader or a jumping expert to watch you perform the following jumping elements and sign off that you perform them accurately and safely.		
Element	Date Completed	Leader's Signature
1. Perform flying lead changes (both directions) in a figure 8		
2. Ride a course of low jumps (18–20 inches high) without irons		
3. Jump a course of at least eight jumps with an in-and-out and an oxer		
4. Change length of strides (from 4 to 5 strides) between jumps (48 inches apart)		

Congratulations! You have successfully completed Level 3 of the Jumping Advancements!

_____ has satisfactorily completed all of the above jumping elements and has, therefore, completed Level 3 of the Oregon 4-H Jumping Advancements.

Name of Club Member

Leader's Signature: _____ Date Approved: _____

1 DRIVING ADVANCEMENTS

1. Name three pieces of attire that are required in driving.

- 1.
- 2.
- 3.

3. Describe the criteria for a header, and briefly describe the header's role.

2. Explain why a longeing-type whip is not permitted in driving.

4. Name three things a horse must be able to do before driving training begins.

- 1.
- 2.
- 3.

Ask your club leader or a driving expert to watch you perform the following driving elements and sign off that you perform them accurately and safely.		
Element	Date Completed	Leader's Signature
1. Demonstrate a smooth, balanced halt from a walk and a slow trot		
2. Demonstrate a slow trot		
3. Demonstrate a working trot		
4. Change directions at a working trot		
5. Perform a circle at a working trot		

Congratulations! You have successfully completed Level 1 of the Driving Advancements!

_____ has satisfactorily completed all of the above driving elements and has, therefore, completed Level 1 of the Oregon 4-H Driving Advancements.

Name of Club Member

Leader's Signature: _____ Date Approved: _____

2 DRIVING ADVANCEMENTS

1. When choosing a driving vehicle, what are three things you should consider so that shafts are appropriate for the horse?

- 1.
- 2.
- 3.

3. Explain how to determine the total load being pulled.

2. What three points of stress on a harness should you particularly check?

- 1.
- 2.
- 3.

4. Explain what you should do if there is a runaway in a driving class.

Ask your club leader or a driving expert to watch you perform the following driving elements and sign off that you perform them accurately and safely.		
Element	Date Completed	Leader's Signature
1. Demonstrate how to safely and correctly harness your horse		
2. Back your horse and vehicle two lengths		
3. Perform a figure 8 at a slow trot		
4. Perform a 180-degree wheel pivot (both directions)		
5. Stop your horse and vehicle; stand for 10 seconds		

Congratulations! You have successfully completed Level 2 of the Driving Advancements!

_____ has satisfactorily completed all of the above driving elements and has, therefore, completed Level 2 of the Oregon 4-H Driving Advancements.

Name of Club Member

Leader's Signature: _____ Date Approved: _____

3 DRIVING ADVANCEMENTS

1. Name three types of bits used in driving and describe how each is used.

- 1.
- 2.
- 3.

3. Describe three different types of driving vehicles.

- 1.
- 2.
- 3.

2. Briefly describe the three different options for holding the reins. Demonstrate these options to your leader.

- 1.
- 2.
- 3.

4. Describe the process of sacking out a horse and getting it accustomed to the shafts and whip.

Ask your club leader or a driving expert to watch you perform the following driving elements and sign off that you perform them accurately and safely.		
Element	Date Completed	Leader's Signature
1. Perform a 360-degree wheel pivot (both directions)		
2. Back through two poles		
3. Correctly ground drive your animal; demonstrate a walk, jog trot, and halt		
4. Trot through two parallel poles with one of your wheels inside the poles		

Congratulations! You have successfully completed Level 3 of the Driving Advancements!

_____ has satisfactorily completed all of the above driving elements and has, therefore, completed Level 3 of the Oregon 4-H Driving Advancements.

Name of Club Member

Leader's Signature: _____ Date Approved: _____

1 GAMING ADVANCEMENTS

1. Use the diagrams below to draw the courses for Texas Barrels and Pole Bending. Use different colors to show the different acceptable routes for each event. Indicate the distances between the barrels/poles.

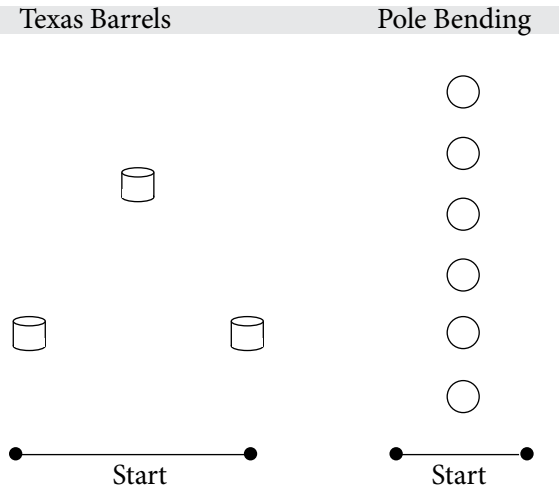

2. When does a rider need to acknowledge the judge in a gaming event?

3. Name four pieces of clothing or tack that are required in Western Games.

- 1.
- 2.
- 3.
- 4.

4. What four basic skills should all horses be able to perform before gaming training begins?

- 1.
- 2.
- 3.
- 4.

5. Name six ways a rider could be disqualified from an event in Western Games.

- 1.
- 2.
- 3.
- 4.
- 5.
- 6.

6. Identify the meaning of the following judge's signals.

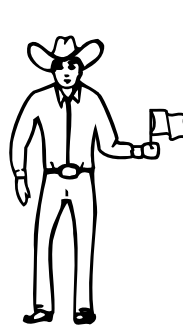

Congratulations! You have successfully completed Level 1 of the Gaming Advancements!

_____ has satisfactorily completed all of the above gaming elements and has, therefore, completed Level 1 of the Oregon 4-H Gaming Advancements.

Name of Club Member

Leader's Signature: _____ Date Approved: _____

2 GAMING ADVANCEMENTS

1. Use the diagrams below to draw the courses for the Figure 8 Stake Race and Key Race. Use different colors to show the different acceptable routes for each event. Indicate the distances between the poles.

Figure 8 Stake Race

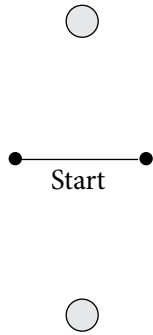

Key Race

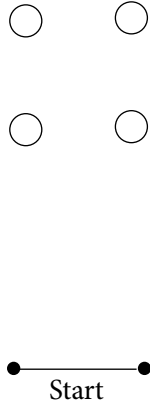

2. What are three reasons that a re-ride would be permitted?

- 1.
- 2.
- 3.

3. Describe how to properly come out of a turn and why that is the proper way.

4. What three things are stressed in all Western gaming classes?

- 1.
- 2.
- 3.

5. Name two types of bits that are allowed in Western gaming classes that are not allowed in Western Equitation.

- 1.
- 2.

6. Describe how to properly acknowledge a judge after completing the course in a gaming event.

7. Identify the meaning of the following judge's signals.

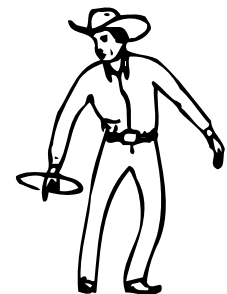

Congratulations! You have successfully completed Level 2 of the Gaming Advancements!

_____ has satisfactorily completed all of the above gaming elements and has, therefore, completed Level 2 of the Oregon 4-H Gaming Advancements.

Name of Club Member

Leader's Signature: _____ Date Approved: _____

3 GAMING ADVANCEMENTS

1. Use the diagram below to draw the course for NSCA Flag Race. Use different colors to show the different acceptable routes for the event. Indicate the distances between the start-finish line and the barrel.

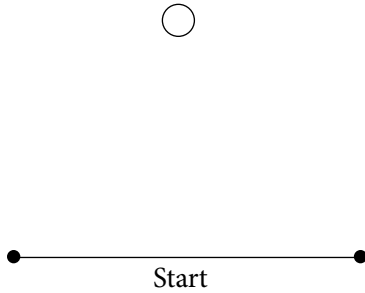

2. Why should you avoid holding on to the cante when turning or stopping?

3. Describe what a pocket is and why it is important for a turn.

4. Name three arena safety rules.

- 1.
- 2.
- 3.

5. Describe an appropriate barrel to use in gaming events. Be sure to mention weight, size, and any other required factors.

6. What is the most important aspect of the Western gaming program?

7. Identify the meaning of the following judge's signals.

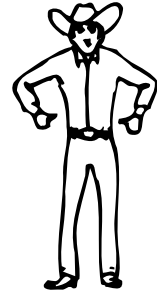
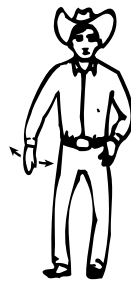

Congratulations! You have successfully completed Level 3 of the Gaming Advancements!

_____ has satisfactorily completed all of the above gaming elements and has, therefore, completed Level 3 of the Oregon 4-H Gaming Advancements.

Name of Club Member

Leader's Signature: _____ Date Approved: _____

1 WORKING RANCH HORSE ADVANCEMENTS

To complete the Level 1 Working Ranch Horse Advancements, you first must complete the Level 1 Riding Advancements.

1. Define a roll back, and describe when and why it might be used.

2. Name four characteristics of a good ranch horse.

- 1.
- 2.
- 3.
- 4.

Ask your club leader or a working ranch horse expert to watch you perform the following working ranch horse elements and sign off that you perform them accurately and safely.

Element	Date Completed	Leader's Signature
1. Demonstrate a balanced stop		
2. Trot three serpentines		
3. Lope two circles with energy		

Congratulations! You have successfully completed Level 1 of the Working Ranch Horse Advancements!

_____ has satisfactorily completed all of the above working ranch horse elements and has, therefore, completed Level 1 of the Oregon 4-H Working Ranch Horse Advancements.

Name of Club Member

Leader's Signature: _____ Date Approved: _____

2 WORKING RANCH HORSE ADVANCEMENTS

To complete the Level 2 Working Ranch Horse Advancements, you first must complete the Level 2 Riding Advancements.

1. What does the phrase “with energy” mean?

2. Describe a proper ranch horse stop.

Ask your club leader or a working ranch horse expert to watch you perform the following working ranch horse elements and sign off that you perform them accurately and safely.		
Element	Date Completed	Leader’s Signature
1. Demonstrate changes in pace at the trot and lope		
2. Perform a rollback from the lope (both directions)		
3. Back freely with energy		

Congratulations! You have successfully completed Level 2 of the Working Ranch Horse Advancements!

_____ has satisfactorily completed all of the above working ranch horse elements and has, therefore, completed Level 2 of the Oregon 4-H Working Ranch Horse Advancements.

Name of Club Member

Leader’s Signature: _____ Date Approved: _____

3 WORKING RANCH HORSE ADVANCEMENTS

To complete the Level 3 Working Ranch Horse Advancements, you first must complete the Level 3 Riding Advancements.

1. Describe a proper ranch horse haunch turn.

2. Name four characteristics that would be considered faults in a ranch horse.

- 1.
- 2.
- 3.
- 4.

Ask your club leader or a working ranch horse expert to watch you perform the following working ranch horse elements and sign off that you perform them accurately and safely.		
Element	Date Completed	Leader's Signature
1. Lope figure 8s and perform three flying lead changes		
2. Demonstrate three consecutive rollbacks, loping with energy, followed by a 10-second stand and settle		

Congratulations! You have successfully completed Level 3 of the Working Ranch Horse Advancements!

_____ has satisfactorily completed all of the above working ranch horse elements and has, therefore, completed Level 3 of the Oregon 4-H Working Ranch Horse Advancements.

Name of Club Member

Leader's Signature: _____ Date Approved: _____

1 RANCH HORSE TRAIL ADVANCEMENTS

To complete the Level 1 Ranch Horse Trail Advancements, you first must complete the Level 1 Trail Advancements.

1. Name three methods of restraining a horse.

- 1.
- 2.
- 3.

2. Identify these two different kinds of chaps:

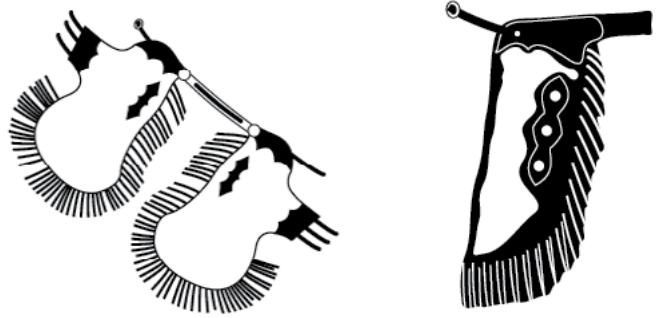

Ask your club leader or a ranch horse trail expert to watch you perform the following ranch horse trail elements and sign off that you perform them accurately and safely.

Element	Date Completed	Leader's Signature
1. Lead your horse over a log		
2. Back your horse through tight obstacles		
3. Demonstrate putting on a slicker while mounted		

Congratulations! You have successfully completed Level 1 of the Ranch Horse Trail Advancements!

_____ *Name of Club Member*

has satisfactorily completed all of the above ranch horse trail elements and has, therefore, completed Level 1 of the Oregon 4-H Ranch Horse Trail Advancements.

Leader's Signature: _____ Date Approved: _____

2 RANCH HORSE TRAIL ADVANCEMENTS

To complete the Level 2 Ranch Horse Trail Advancements, you first must complete the Level 2 Trail Advancements.

1. Describe how the horse should approach a trail obstacle.

2. What type of reins are suggested for use in a ranch horse trail class?

Ask your club leader or a ranch horse trail expert to watch you perform the following ranch horse trail elements and sign off that you perform them accurately and safely.		
Element	Date Completed	Leader's Signature
1. Lead your horse through a gate		
2. Demonstrate dallying and dragging an object (such as brush) forward		
3. Walk your horse by three unusual objects that would not be found in a regular trail class (tent, hide, sign, etc.)		
4. Ground tie your horse		

Congratulations! You have successfully completed Level 2 of the Ranch Horse Trail Advancements!

_____ has satisfactorily completed all of the above ranch horse trail elements and has, therefore, completed Level 2 of the Oregon 4-H Ranch Horse Trail Advancements.

Name of Club Member

Leader's Signature: _____ Date Approved: _____

3 RANCH HORSE TRAIL ADVANCEMENTS

To complete the Level 3 Ranch Horse Trail Advancements, you first must complete the Level 3 Trail Advancements.

1. Describe how to hobble a horse.

2. Why is a breast collar required in ranch horse trail riding?

Ask your club leader or a ranch horse trail expert to watch you perform the following ranch horse trail elements and sign off that you perform them accurately and safely.		
Element	Date Completed	Leader's Signature
1. Walk your horse through water		
2. Demonstrate dallying and dragging an object (such as brush) backward		
3. Demonstrate loading your horse in a trailer		

Congratulations! You have successfully completed Level 3 of the Ranch Horse Trail Advancements!

_____ has satisfactorily completed all of the above ranch horse trail elements and has, therefore, completed Level 3 of the Oregon 4-H Ranch Horse Trail Advancements.

Name of Club Member

Leader's Signature: _____ Date Approved: _____

1 COW WORKING ADVANCEMENTS

1. List three reasons cattle should be worked slowly and quietly.

- 1.
- 2.
- 3.

3. What is the definition of “flight zone?”

2. What are a cow’s two blind spots?

- 1.
- 2.

4. What is a cow’s automatic response to a threat?

Ask your club leader or a cow working expert to watch you perform the following cow working elements and sign off that you perform them accurately and safely.		
Element	Date Completed	Leader’s Signature
1. Walk through a herd of cattle		
2. Move a small herd across an arena or pen		

Congratulations! You have successfully completed Level 1 of the Cow Working Advancements!

_____ has satisfactorily completed all of the above cow working elements and has, therefore, completed Level 1 of the Oregon 4-H Cow Working Advancements.

Name of Club Member

Leader’s Signature: _____ Date Approved: _____

2 COW WORKING ADVANCEMENTS

1. What is the “point of balance”? How does it affect moving cattle?

2. Name three reasons it is bad to handle cattle roughly.

- 1.
- 2.
- 3.

Ask your club leader or a cow working expert to watch you perform the following cow working elements and sign off that you perform them accurately and safely.		
Element	Date Completed	Leader’s Signature
1. Hold a small herd in one location on a wall		
2. Separate two random cattle from a herd		
3. Move one calf out of a herd to a designated area, hold it for a short time, and then release it back to the herd		

Congratulations! You have successfully completed Level 2 of the Cow Working Advancements!

_____ has satisfactorily completed all of the above cow working elements and has, therefore, completed Level 2 of the Oregon 4-H Cow Working Advancements.

Name of Club Member

Leader’s Signature: _____ Date Approved: _____

3 COW WORKING ADVANCEMENTS

1. Name two reasons it is good to keep some distance between you and the cow your are working.

- 1.
- 2.

2. Name three signs that a cow is nervous.

- 1.
- 2.
- 3.

Ask your club leader or a cow working expert to watch you perform the following cow working elements and sign off that you perform them accurately and safely.		
Element	Date Completed	Leader's Signature
1. Move a calf around an obstacle (such as a cone)		
2. Move a small herd and hold it in all four corners of an arena		
3. Separate three designated calves, one at a time, from a herd		
4. Separate a designated calf from a herd, move it to the other end of a pen/arena, and hold it on a fence for at least five seconds		

Congratulations! You have successfully completed Level 3 of the Cow Working Advancements!

_____ has satisfactorily completed all of the above cow working elements and has, therefore, completed Level 3 of the Oregon 4-H Cow Working Advancements.

Name of Club Member

Leader's Signature: _____ Date Approved: _____

1 ROPING ADVANCEMENTS

1. Identify the following parts of a rope on the picture below: spoke, honda, coils, and loop.

2. Name two reasons why a rancher would rope a cow.

1.

2.

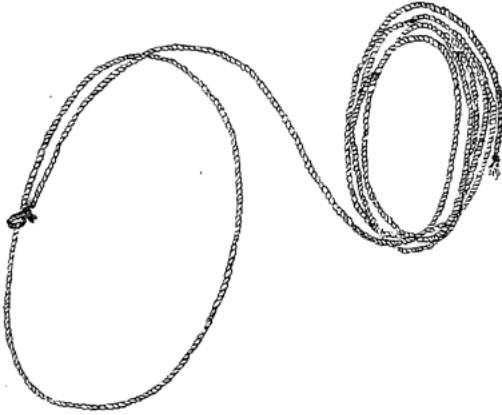

Ask your club leader or a roping expert to watch you perform the following roping elements and sign off that you perform them accurately and safely.		
Element	Date Completed	Leader's Signature
1. Demonstrate how to properly coil a lariat		
2. Demonstrate how to properly build a loop		
3. Demonstrate how to properly swing a rope		
4. From the ground, rope a calf head in a bale of hay		

Congratulations! You have successfully completed Level 1 of the Roping Advancements!

_____ has satisfactorily completed all of the above roping elements and
Name of Club Member has, therefore, completed Level 1 of the Oregon 4-H Roping Advancements.

Leader's Signature: _____ Date Approved: _____

2 ROPING ADVANCEMENTS

1. What does “wrapping the horn” mean, and why is it done?

3. Explain where the horse should be in relation to the calf when roping.

2. Explain how to select and purchase the right rope.

4. What are a “header” and a “heeler”?

Ask your club leader or a roping expert to watch you perform the following roping elements and sign off that you perform them accurately and safely.		
Element	Date Completed	Leader’s Signature
1. Demonstrate laying the rope against both sides of the horse and dragging it off both sides		
2. From horseback, rope a calf head in a bale of hay		

Congratulations! You have successfully completed Level 2 of the Roping Advancements!

_____ has satisfactorily completed all of the above roping elements and
Name of Club Member has, therefore, completed Level 2 of the Oregon 4-H Roping Advancements.

Leader’s Signature: _____ Date Approved: _____

3 ROPING ADVANCEMENTS

1. What is a breakaway honda, and why is it used?

2. What does the term “lay” refer to?

Ask your club leader or a roping expert to watch you perform the following roping elements and sign off that you perform them accurately and safely.		
Element	Date Completed	Leader’s Signature
1. Demonstrate a proper dally		
2. From horseback, rope a calf in a small pen		

Congratulations! You have successfully completed Level 3 of the Roping Advancements!

_____ has satisfactorily completed all of the above roping elements and
Name of Club Member has, therefore, completed Level 3 of the Oregon 4-H Roping Advancements.

Leader’s Signature: _____ Date Approved: _____

1 IDENTIFICATION AND SKILLS ADVANCEMENTS

1. Name three popular cattle breeds.

- 1.
- 2.
- 3.

2. What is the average temperature of a normal cow?

_____ degrees Fahrenheit

3. Name two ways to identify cow ownership.

- 1.
- 2.

4. What is a dewlap on a cow?

5. Identify the following ranch equipment items:

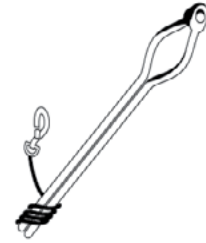

Ask your club leader or a ranch horse expert to watch you perform the following ranch horse elements and sign off that you perform them accurately and safely.		
Element	Date Completed	Leader's Signature
1. Demonstrate tying a bowline knot		
2. Demonstrate tying a slip knot		

Congratulations! You have successfully completed Level 1 of the Identification and Skills Advancements!

_____ has satisfactorily completed all of the above identification and skills elements and has, therefore, completed Level 1 of the Oregon 4-H Identification and Skills Advancements.

Name of Club Member

Leader's Signature: _____ Date Approved: _____

2 IDENTIFICATION AND SKILLS ADVANCEMENTS

1. Name three signs that a cow is healthy.

- 1.
- 2.
- 3.

2. What is the gestation period of a cow?

_____ months

3. Describe the differences between hot iron branding and freeze branding.

4. What is the definition of a composite breed?

5. Identify the following ranch equipment items:





5. How should these brands be read?



① _____

② _____

③ _____

Ask your club leader or a ranch horse expert to watch you perform the following ranch horse element and sign off that you perform it accurately and safely.

Element	Date Completed	Leader's Signature
1. Demonstrate tying a clove hitch knot and a half hitch knot		

Congratulations! You have successfully completed Level 2 of the Identification and Skills Advancements!

_____ has satisfactorily completed all of the above identification and skills elements and has, therefore, completed Level 2 of the Oregon 4-H Identification and Skills Advancements.

Leader's Signature: _____ Date Approved: _____

3 IDENTIFICATION AND SKILLS ADVANCEMENTS

1. Name three signs that a cow is not feeling well.

- 1.
- 2.
- 3.

2. Name three common vaccines for cattle.

- 1.
- 2.
- 3.

3. Describe the strengths and weaknesses of two breeds of cattle.

Breed 1: _____

Strengths: _____

Weaknesses: _____

Breed 2: _____

Strengths: _____

Weaknesses: _____

4. Identify the following ranch equipment items:



Ask your club leader or a ranch horse expert to watch you perform the following ranch horse element and sign off that you perform it accurately and safely.

Element	Date Completed	Leader's Signature
1. Demonstrate tying a honda knot and a trucker's hitch knot		

Congratulations! You have successfully completed Level 3 of the Identification and Skills Advancements!

Name of Club Member

has satisfactorily completed all of the above identification and skills elements and has, therefore, completed Level 3 of the Oregon 4-H Identification and Skills Advancements.

Leader's Signature: _____ Date Approved: _____

ADVANCEMENTS AND COMPLETION CHECKLIST

Keep track of the advancements that you complete, and have your club leader initial this sheet when you complete advancement levels.

Advancement	Level 1	Level 2	Level 3
<u>General Advancements</u>			
Knowledge Advancements	_____	_____	_____
Ground Work Advancements	_____	_____	_____
Riding Advancements	_____	_____	_____
Personal Development Advancements	_____	_____	_____
<u>Specialty Advancements</u>			
Trail Advancements	_____	_____	_____
Jumping Advancements	_____	_____	_____
Driving Advancements	_____	_____	_____
Gaming Advancements	_____	_____	_____
<u>Ranch Horse Advancements</u>			
Working Ranch Horse Advancements	_____	_____	_____
Ranch Horse Trail Advancements	_____	_____	_____
Cow Working Advancements	_____	_____	_____
Roping Advancements	_____	_____	_____
Identification and Skills Advancements	_____	_____	_____

Cover photo by Andy Hoffman

Revised by Pam Lundeberg, 4-H horse project leader; and Roberta Lundeberg, Extension 4-H youth development state program coordinator, Oregon State University. Reviewed by the Oregon 4-H State Horse Advisory. Originally developed by Duane P. Johnson, Extension 4-H specialist emeritus; and W. Dean Frischknecht, Extension animal science specialist emeritus; both of Oregon State University.

© 2013 Oregon State University.

Extension work is a cooperative program of Oregon State University, the U.S. Department of Agriculture, and Oregon counties. Oregon State University Extension Service offers educational programs, activities, and materials without discrimination based on age, color, disability, gender identity or expression, genetic information, marital status, national origin, race, religion, sex, sexual orientation, or veteran's status. Oregon State University Extension Service is an Equal Opportunity Employer.

Revised June 2005. Revised October 2013.