

AN ABSTRACT OF THE THESIS OF

William Sanford Plank for the Master of Science  
(Name) (Degree)

in Oceanography presented on July 15, 1970  
(Major) (Date)

Title: AN EXPERIMENTAL EVALUATION OF A PASSIVE ANTI-ROLL TANK SYSTEM

Abstract approved: Redacted for privacy  
Dr. George Beardsley

The effectiveness of the passive anti-roll tank system aboard the R/V YAQUINA was determined. Measurements of ship roll, effective waveslope and tank water transfer were analyzed using a systems analysis technique. Time series of the inputs and outputs of the ship/tank system and of the tank itself were processed using spectral analysis methods in order to obtain system transfer functions for stabilized and unstabilized configurations. Comparison of these transfer functions showed that the anti-roll tank system has a significant and beneficial effect on the rolling performance of the vessel.

An Experimental Evaluation of a  
Passive Anti-Roll Tank System

by

William Sanford Plank

A THESIS

submitted to

Oregon State University

in partial fulfillment of  
the requirements for the  
degree of

Master of Science

June 1971

APPROVED:

Redacted for privacy

---

Associate Professor of Oceanography

in charge of major

Redacted for privacy

---

Head of Department of Oceanography

Redacted for privacy

---

Dean of Graduate School

Date thesis is presented July 15, 1970

Typed by Barbara Eby for William Sanford Plank

## ACKNOWLEDGEMENT

The author is deeply indebted to Dr. George F. Beardsley, Jr., his thesis advisor, for his invaluable guidance and advice. Thanks are also due to Dr. Wayne V. Burt, for his interest and support of the project, and to the crew of the R/V YAQUINA, in particular Captain Howard Linse and Chief Engineer Robert Ingersoll, without whose cooperation and assistance the work could not have been done.

This investigation was supported by N00014-67-A-0369-0007.

## TABLE OF CONTENTS

|  |    |
|--|----|
| INTRODUCTION   | 1  |
| Background   | 1  |
| Statement of the Problem   | 7  |
| EXPERIMENTAL PROCEDURE   | 10 |
| The Systems Analysis Technique   | 10 |
| The Determination of the Transfer Functions for<br>the Ship- Tank System | 13 |
| The Data Acquisition System  | 18 |
| EXPERIMENTAL RESULTS   | 23 |
| DISCUSSION   | 35 |
| BIBLIOGRAPHY   | 42 |
| APPENDIX I - THE OPERATION OF THE PASSIVE ANTI-<br>ROLL TANK             | 43 |
| APPENDIX II - COMPUTER PROGRAMS  | 51 |
| APPENDIX III - RESULTS OF SPECTRAL ANALYSES                              | 56 |

## LIST OF FIGURES

| <u>Figure</u> |  | <u>Page</u> |
|---------------|--|-------------|
| 1             | Types of passive anti-roll tanks.  | 4           |
| 2             | Anti-roll tank, R/V YAQUINA (not to scale).  | 6           |
| 3             | Measurement of roll angle and effective waveslope.   | 15          |
| 4             | Yawing (Burger and Corbet, 1966).  | 16          |
| 5             | Schematic of data acquisition system.  | 19          |
| 6             | Spectral densities and coherence - Record 1131 (unstabilized).                             | 24          |
| 7             | Spectral densities and coherence - Record 1136 (stabilized).                               | 25          |
| 8             | Tank pressure spectral density and coherence between tank pressure and roll - Record 1136. | 26          |
| 9             | Comparison of measured and derived waveslope spectra.                                      | 29          |
| 10            | Phase differences.   | 31          |
| 11            | Transfer functions - unstabilized configuration.   | 32          |
| 12            | Transfer functions - stabilized configuration.   | 34          |
| 13            | Average transfer functions.  | 36          |
| 14            | Amplitude of second-order transfer functions as a function of damping ratio.               | 38          |
| A. 1          | Influence of coefficients of equations of motion (van den Bosch, 1967).                    | 45          |
| A. 2          | Components of tank moment (van den Bosch, 1967).   | 47          |
| A. 3          | Schematic presentation of tank influence (van den Bosch, 1967).                            | 49          |

# AN EXPERIMENTAL EVALUATION OF A PASSIVE ANTI-ROLL TANK SYSTEM

## INTRODUCTION

### Background

For almost a hundred years the problem of the reduction of ship roll has been investigated. Some of the considerations which have prompted these efforts have included a desire for increased comfort on passenger liners, the demands of the military for steadier gun platforms, and a need on all types of working vessels, including fishing boats and oceanographic ships, for a more stable platform which would produce safer and more efficient working conditions.

The types of stabilizers which have been tried include bilge keels, the movement of solid weights, water transfer in tanks, gyroscopes, and external fin movement. These systems can be divided into two classes--passive systems and active systems. In passive systems (bilge keels and some tanks) no control devices or external power are needed for the operation of the system. In active systems sensing elements, feedback loops, and control devices determine the motion of the ship and operate the stabilizer so as to produce the maximum stabilizing effect. In many cases, active systems can produce more effective stabilization, but at the penalties of higher cost and high power consumption.

Bilge keels are planes or fins attached at the turn of the bilge. They are most effective when they project at right angles to the hull, and they usually extend over about one-third of the ships length. First fitted to ships around 1870, bilge keels are most effective in reducing large angles of roll. The resistance they cause varies approximately with the square of the angular roll velocity, and they tend to increase the roll period.

A stabilizer system utilizing the movement of solid weights was first installed in about 1891 by Thornycroft on the yacht Cecile, and several other experimental systems of this type were tried at about the same time. These early efforts achieved little success, mainly because of a lack of knowledge of the operation of control systems and servo-mechanisms.

The use of large, high speed gyroscopes as ship stabilizers was first tried in 1906. Rigidly attached to the ship in the athwartships plane, the gyro was allowed to precess in the fore and aft plane as the ship rolled, exerting a force which resisted the rolling. Gyro stabilizers were installed in about forty ships. Although many of these installations were effective in reducing roll, production has ceased mainly due to the weight, cost, and space requirements of the system.

The external fin stabilizer has proved to be one of the most effective systems for high speed ships. The fins protrude from the hull below the water line and are operated by a control system so that



the forward motion of the ship produces a lift in one direction on one fin and in the opposite direction on the other. The resulting couple resists the rolling motion of the ship. Developed to a high degree of efficiency by the Denny Brown Company, fin stabilizers have been installed on over 100 ships including the Queen Elizabeth and Queen Mary. Most recent installations have been of the retractable type, so that the drag of the fins may be eliminated in calm seas, and no complications are encountered in docking the ship.

The first anti-roll tanks were installed on a ship by Froude in 1874. These were free surface tanks which lengthened the period of the ships roll, but also reduced its stability. Prior to World War I, Hermann Frahm (see Figure 1) developed the U-tube tank situated above the center of gravity of the ship. Situated in this position, the tanks took advantage of the stabilizing component developed by the horizontal acceleration of the water toward the high side of the ship. Frahm realized the importance of tuning the tanks so that the natural period of water transfer in the tank was approximately equal to the natural period of roll of the ship. Tuning was accomplished by varying the cross-section of the horizontal duct and/or by controlling the flow of air in a duct which connected the tops of the tanks. Frahm's passive tanks were installed in over 1,000,000 tons of German shipping before World War II.

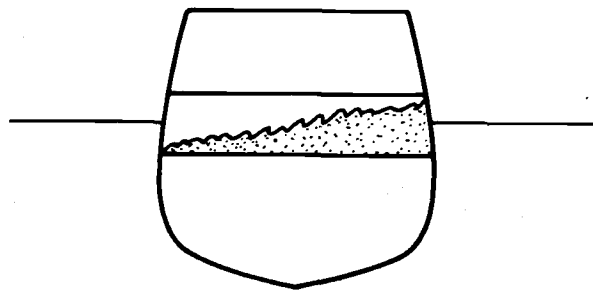

**FREE SURFACE TANK**

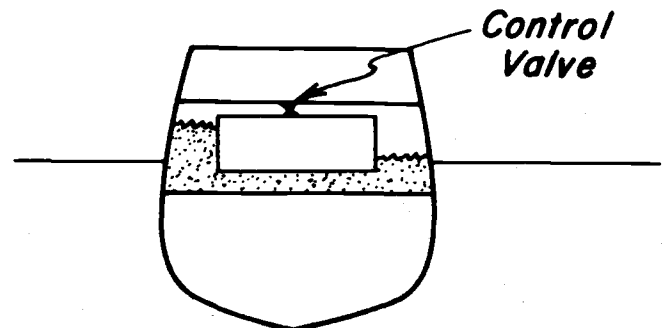

**U-TUBE TANK**

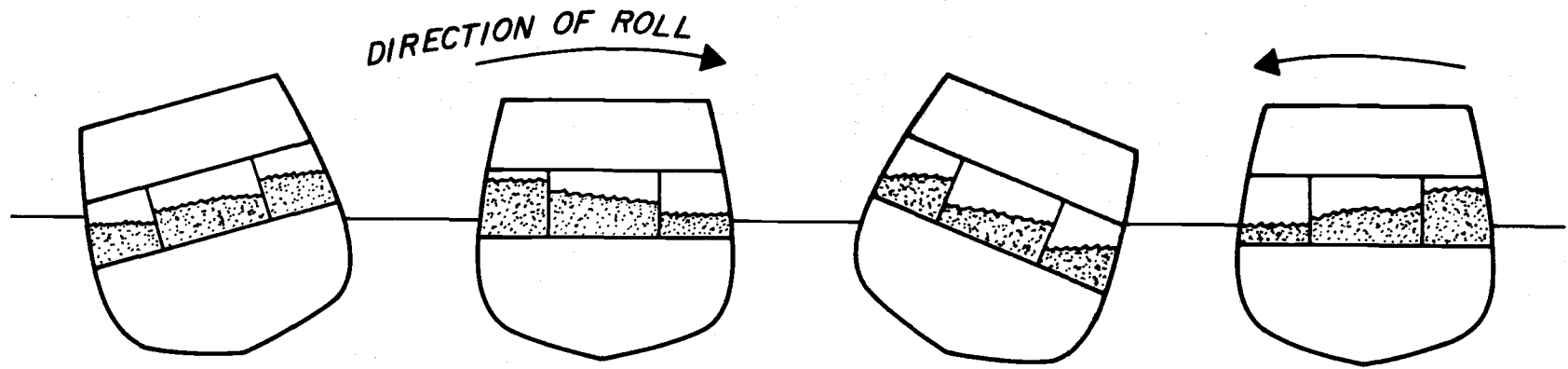

**OPERATION OF FLUME TANK**

Figure 1. Types of passive anti-roll tanks.

Activated anti-roll tanks were developed in this country by Minorsky during the 1920's. In these tanks, the flow of water was controlled by a variable pitch pump located in the horizontal duct. Using this system it was possible to attain a higher degree of stabilization over a wider range of roll frequencies, but at a higher cost because of the necessary control system.

A recent development in passive tank design has been the introduction of the "diversified" or flume tank. In this system a transverse tank is divided into three sections by two sets of nozzle restrictions or ducts. The nozzles control the rate of fluid flow back and forth in the tank. The natural frequency of the tank is determined by the cross-sectional area of the tank sections, the size and shape of the nozzles and the depth of the liquid in the tank.

In determining the type of stabilization system to be used on a ship, several factors should be considered. These include money and space available, degree of stabilization desired or required, and the mode of operation of the ship. For large, high speed ships, external fins or activated tanks can provide excellent stabilization at a relatively high price. On ships which operate at low speeds or on station, and for which cost is more important than degree of stabilization, a passive tank may be the most desirable system.

The stabilization system installed on the R/V YAQUINA, with which this paper is concerned, is of the passive flume tank type. It is

a tank of rectangular cross-section measuring 32 ft. wide by 6 ft. deep in the fore and aft direction by 4.5 ft. high with a design water depth of 2.25 ft. There are two nozzle sections, each located 8 ft. from the ends of the tank, consisting of a row of vertical stanchions of square cross-section. The stanchions are on 1.3 ft. centers with a 0.6 ft. space between. When filled to design water depths, the tank contains 13.5 tons of water which is 1.65% of the ship's displacement. A schematic of the tank is shown in Figure 2.

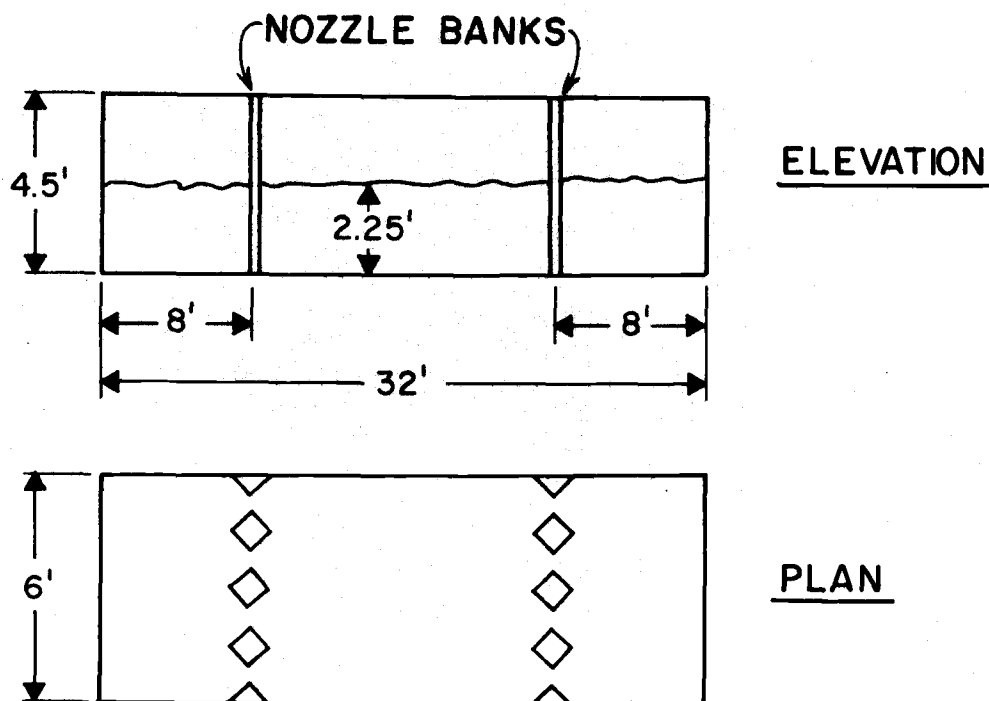

Figure 2. Anti-roll tank, R/V YAQUINA (not to scale).

## Statement of the Problem

The purpose of this study is to evaluate the performance of the anti-roll tank installation on the R/V YAQUINA. An attempt is also made to determine if any changes in the tank's performance could be effected by changing the water level in the tank.

A great deal of progress has been made in the theoretical investigation of the behavior of ships equipped with anti-roll tanks, in particular in the paper by Chadwick and Klotter (1954), and a substantial amount of model testing has also been done (Van den Bosch and Vugts, 1966). However, in the area of full-scale tests of stabilizer installations, some confusion seems to exist as to the proper method of testing and the criteria to be used in evaluating the tests. In most early tests, an attempt was made to measure maximum roll angles encountered and results are often reported in terms of percent stabilization. It is assumed that this refers to the difference in maximum roll angle under unstabilized and stabilized conditions.

The problem with evaluating a roll tank test in this way is that no account is taken of the random nature of ship roll and of the waves which cause the roll. In more recent papers the use of various statistical measures of roll tank performance is discussed. In Chadwick (1955) the results of model tests are studied by comparing root mean square (RMS) values of roll, and in Van den Bosch (1967), also

concerned with model studies, roll energy spectra are compared for stabilized and unstabilized models.

Since test conditions in model studies can be carefully controlled, both these methods are valid. However, the comparison of spectra gives more information, since the performance at different frequencies may be studied. Vasta et al. (1961) discuss the use of roll energy spectra in full-scale tests at sea. In the tests reported in this paper comparison is made between stabilized and unstabilized conditions by computing the areas under the appropriate spectra, thus obtaining an RMS value for the roll. However, the authors indicate that great care should be taken in such tests to insure that sea conditions throughout the tests are as consistent as possible. It is obvious that if sea conditions change appreciably between the times that the unstabilized and stabilized tests are made, comparison of measured roll spectra will be meaningless.

In a roll tank installation such as the one found on the R/V YAQUINA, the only method of changing the ship from the unstabilized to the stabilized condition is to fill the tank to the desired water level using the ship's pumps--a process which takes about two hours. Given this length of time between tests, it was felt that changing sea conditions would probably render invalid an evaluation made by simple comparison of spectra.

It was, therefore, felt that a better method of testing the R/V AQUINA'S roll tank was needed and that such a method was available in the form of the system's analysis technique.

## EXPERIMENTAL PROCEDURE

### The Systems Analysis Technique

It is convenient to think of an electrical or mechanical system as a "black box" which is excited by an input  $f(t)$  and which produces a response to this input--the output  $r(t)$ . An ideal system of this type is one which has constant parameters and is linear between the input or excitation point and the output or response point. A system has constant parameters if all fundamental properties of the system are invariant with respect to time. In our case this would mean that the roll moment of inertia, the roll damping coefficient, and the roll righting coefficient would not change with time. A system is linear if the response characteristics are additive and homogeneous.

While there are certain non-linearities in the ship-tank system, almost all studies of ship motion, and, especially those concerned with making engineering approximations, consider the system to be linear (Chadwick and Klotter, 1954, Weinblum and St. Denis, 1950, Chadwick, 1955). This is an especially good approximation when considering the moderate amplitudes of roll that a stabilized ship undergoes.

The dynamic characteristics of a constant parameter linear system can be described by its impulse response function  $h(t)$  which is defined as the output of the system at any time, given a unit impulse applied at  $t=0$ . For any arbitrary input  $f(t)$  the system output  $r(t)$



is given by the convolution integral

$$r(t) = \int_{-\infty}^{\infty} f(\tau)h(t-\tau)d\tau \quad (1)$$

For the purpose of this study, the most important characteristic of a linear system is the transfer function  $H(\omega)$  which is defined as the Fourier transform of the impulse response function. That is

$$H(\omega) = \int_0^{\infty} h(t)e^{-j\omega t} dt \quad (2)$$

The transfer function of a system describes the dynamic characteristics of the system in frequency space and is, of course, independent of the amplitude or frequency composition of the input. A schematic of a typical linear system is shown below.

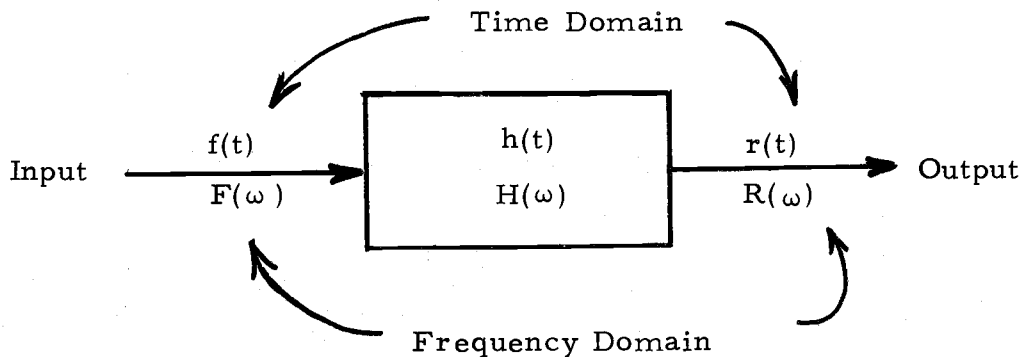

An important relationship involving the transfer function is obtained by taking the Fourier transform of both sides of Equation (1). If  $F(\omega)$  is the transform of the input  $f(t)$  and  $R(\omega)$  is the transform of the output  $r(t)$  we obtain

$$R(\omega) = H(\omega) F(\omega) \quad (3)$$

For any signal  $r(t)$  with Fourier transform  $R(\omega)$  it can be shown that the power-density spectrum  $S_r(\omega)$  is given by

$$S_r(\omega) = \lim_{T \rightarrow \infty} \frac{|R(\omega)|^2}{T} \quad (4)$$

Given a system with input  $r(t)$  and output  $f(t)$  we have, using Equation (3)

$$\begin{aligned} S_r(\omega) &= \lim_{T \rightarrow \infty} \frac{1}{T} |H(\omega) F(\omega)|^2 \\ &= |H(\omega)|^2 \lim_{T \rightarrow \infty} \frac{1}{T} |F(\omega)|^2 \end{aligned}$$

$$S_r(\omega) = |H(\omega)|^2 S_f(\omega)$$

or

$$|H(\omega)| = \sqrt{\frac{S_r(\omega)}{S_f(\omega)}} \quad (5)$$

where  $S_f(\omega)$  is the power-density spectrum of the input signal  $f(t)$  and  $|H(\omega)|$  is the magnitude of the complex function  $H(\omega)$ . Equation (5) provides the essential relationship utilized in this study. We see that, if we can determine the power-density spectra for the inputs and outputs of the ship-tank system, we can then determine the transfer function. If we do this when the tank is operating and when it is not operating, the comparison of the two resulting transfer functions

should reveal what, if any, effect the tank has on the rolling of the ship. Note that the sea conditions do not have to be the same during the "operating" and the "non-operating" test, since the transfer function is independent of the amplitude and frequency composition of the input and output. We are thus free to conduct the tests at any time and in almost any sea conditions. Of course, there must be a rough enough sea to provide measurable roll but not so rough that the non-linearities of the system become important.

#### The Determination of the Transfer Functions for the Ship-Tank System

We may now draw a diagram of the ship-tank system with appropriate inputs and outputs:

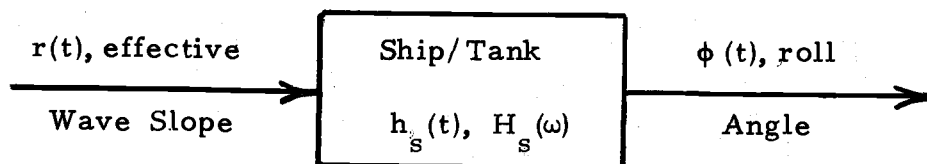

The slope of the sea surface on which the ship rides is the most appropriate variable for describing the input to the system, in this case, since the torque which tends to roll the ship is closely related to the waveslope. If we were to attempt to measure the torque directly we would require a sufficient number of pressure sensors on the hull of the ship to adequately describe the pressure field--a relatively impractical procedure.

Note that the input shown above is the effective waveslope. This may be thought of as a measure of the total rolling torque due to the waves, expressed as the static list which this torque would produce. The "actual waveslope, or slope of the water surface at any point, is a vector function of position; whereas effective waveslope is a scalar function of time alone. We can see that the effect of the ship will be to integrate out the higher spatial and temporal frequencies of the "actual" waveslope, and its motion will be a result principally of the lower frequencies.

If we consider the case of a ship in waves whose lengths are long compared with its own, we can assume that the ship undergoes an orbital motion which corresponds to the orbital motion of the water particles. Wave theory shows that the apparent gravity vector at the surface in a wave field acts along the normal to the wave slope. We might, therefore, assume that for long waves in particular, and to a lesser extent in short waves, the apparent vertical on board a ship is always normal to the effective waveslope.

Given this fact, we see that a pendulum aboard the ship, with a natural period short relative to the roll period of the ship, will tend to align itself with the normal to the effective waveslope. If we can record a signal proportional to the deflection of this pendulum and another signal which indicates the true vertical, from a gyroscope for example, the difference between these two signals will contain the information we

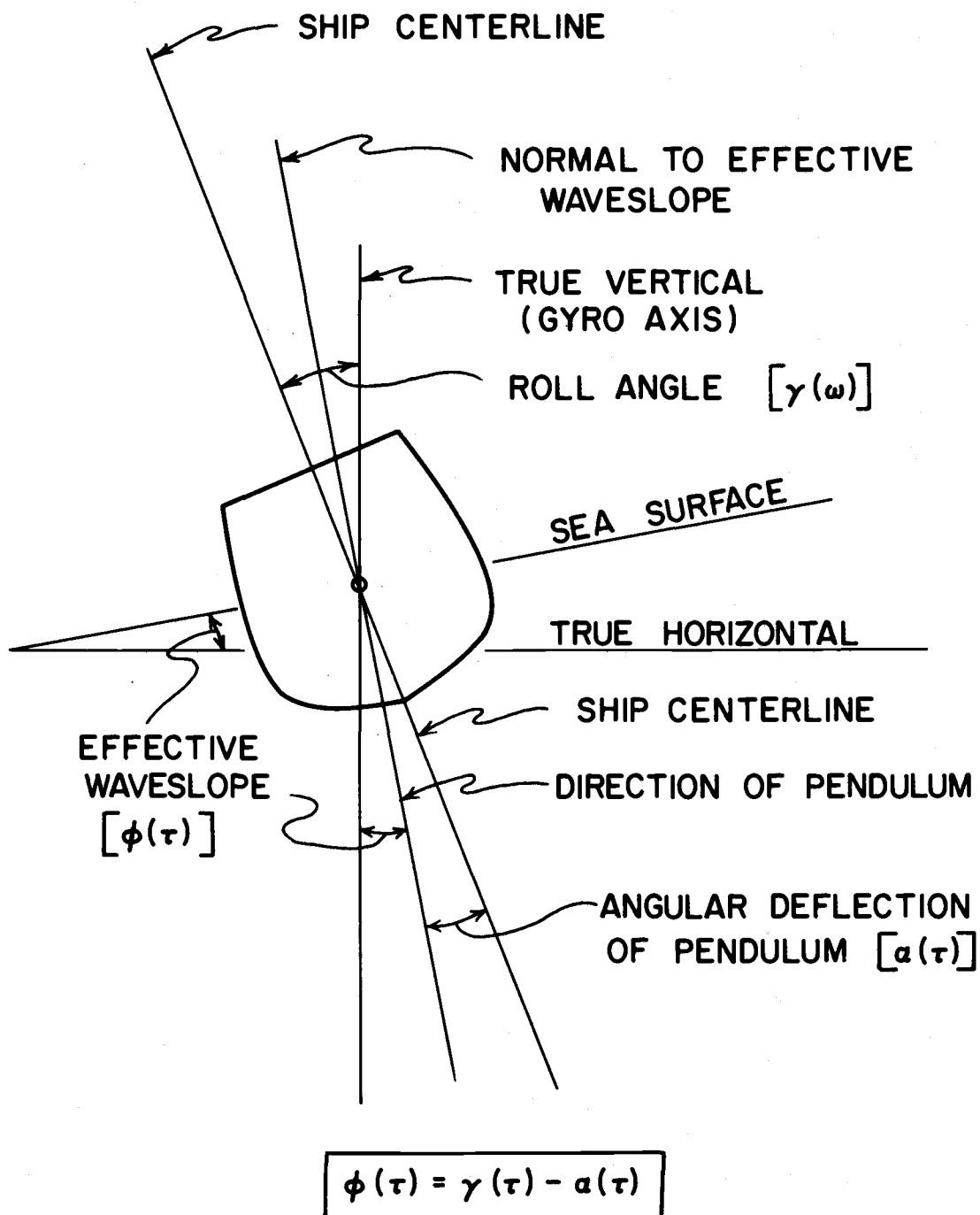

Figure 3. Measurement of roll angle and effective waveslope

seek, that is, the inclination of the effective waveslope relative to the horizontal. The signal from the gyroscope will, of course, also reveal the instantaneous angle of roll of the ship (see Figure 3).

One factor which might tend to produce an error in our measurement of the effective waveslope is the presence of yaw-heel rolling. This type of roll is caused by the yawing of the ship. As the ship yaws, a couple is produced by the centrifugal force acting through the center of gravity of the ship and the resultant lateral resistance force acting below the waterline. This couple tends to heel the ship away from the center of the turning circle, and the period of the rolling equals the apparent period of the waves.

A ship yaws as a result of the forces on the hull produced by the orbital motion of the water particles in a wave profile. It should be obvious from Figure 4 below that yawing is greatest when the ship is travelling at some angle relative to the direction of the wave crests and is a minimum when the wave crests are parallel to the direction of travel.

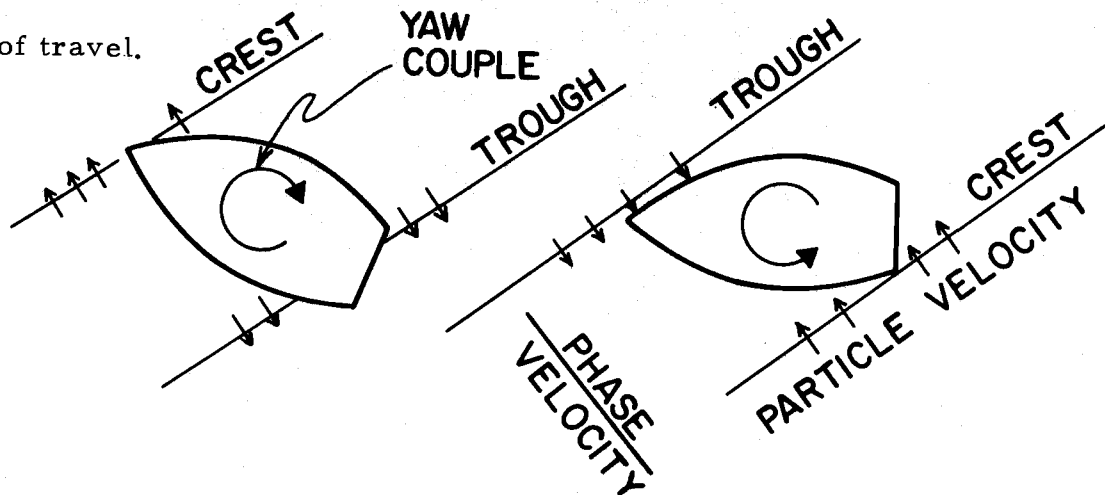
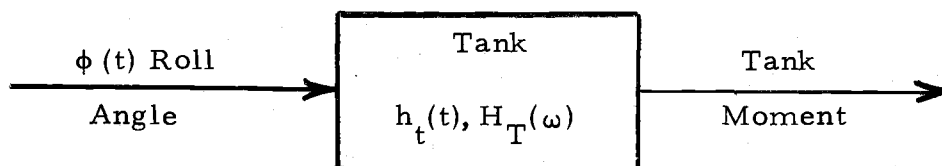

Figure 4. Yawing (Burger and Corbet, 1966).

Therefore, in order to minimize the error in our waveslope measurements, we should conduct our tests with the ship traveling (or laying to) in line with the wave crests and troughs.

We have seen that by measuring the waveslope and the roll angle, we can determine the properties of the ship tank system. The tank itself constitutes another system as shown below:



We would like to analyze this system to obtain some of the properties of the tank, specifically, the natural frequency of the tank and the phase relationship between the water motion in the tank and the roll of the ship. We have already seen that the roll angle can be obtained by means of gyroscope. An indication of tank moment or "anti-roll torque" can be obtained by measuring the transfer of water back and forth in the tank, and we can do this by measuring the variations in pressure at one point in the tank.

These, then, are the parameters to be measured:

effective waveslope

ship roll angle

tank pressure

With these measurements, we can determine the transfer functions of the ship/tank system and the important properties of the tank itself.

### The Data Acquisition System

A schematic of the data acquisition system is shown in Figure 5. The pendulum is a Humphrey model CP17-1601-1 with a range of  $\pm 45^\circ$  and a natural frequency of approximately 3 Hz. The output of the pendulum is obtained through a precision 2000 ohm potentiometer. The pendulum was located on the ship as closely as possible to the roll axis in order to minimize errors due to radial accelerations.

The gyro is a surplus Army Air Forces vertical flight gyro manufactured by Carl L. Norden, Inc. It was originally used in a type C-1 autopilot. The output of the gyro is also obtained through a precision potentiometer.

The pressure transducer is an Ocean Engineering Corp. Model PT-404. It is a strain gage Wheatstone bridge device utilizing a slow leak to prevent measuring low frequency and mean pressures. The transducer is mounted in a painter's pressure tank which is connected by a pipe to the anti-roll tank. The water pressure variations in the tank are transmitted to the paint tank where they are detected by the transducer. The signal from the transducer is amplified by a Keithley Electrometer. The electrometer also provides a visual



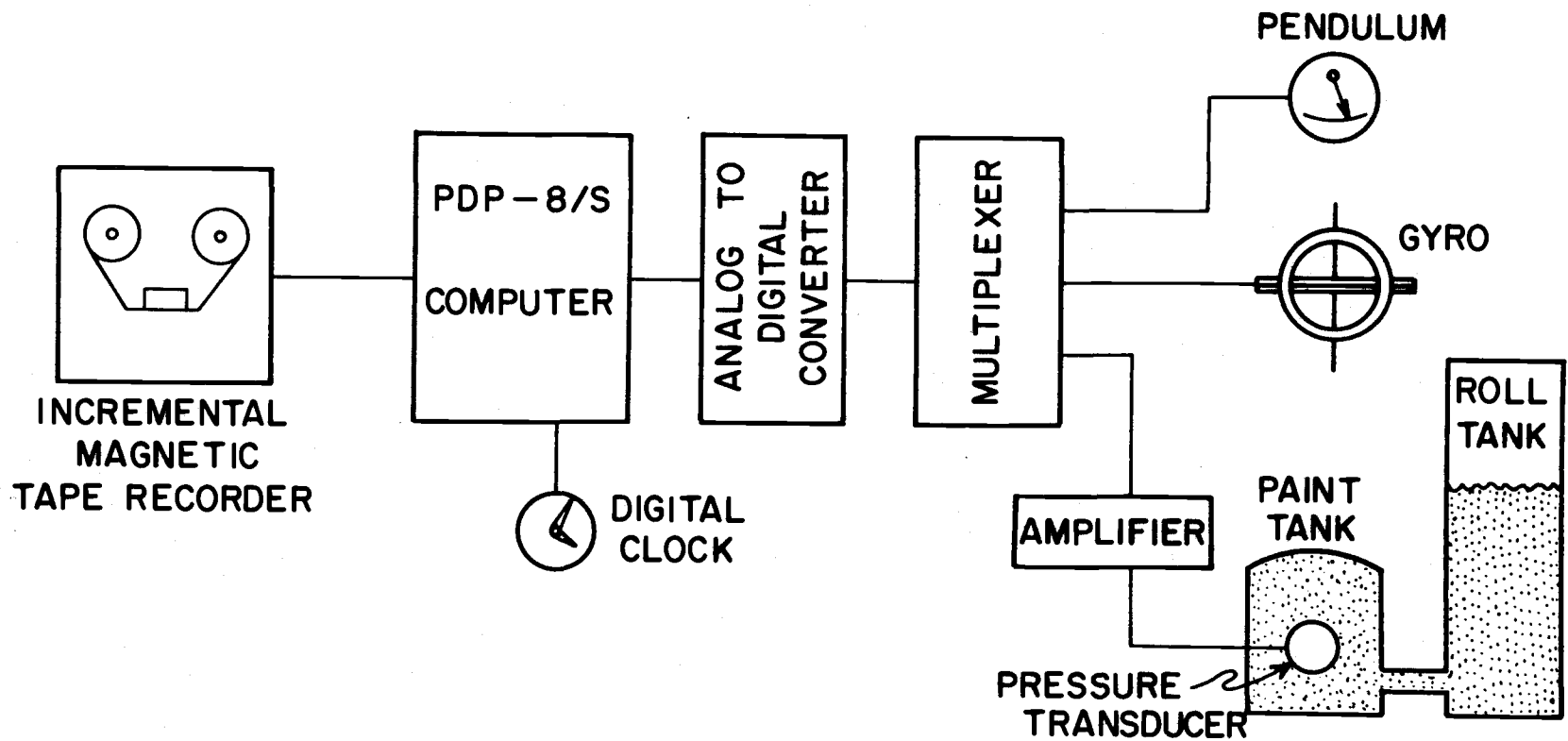

Figure 5. Schematic of data acquisition system.

indication of the pressure variations in the tank.

The entire data sampling process is controlled by a Digital Equipment Corporation PDP-8/S computer, a small scale general purpose computer, having a 4096 word memory with an 8 microsecond cycle time.

Analog signals from the sensors are fed into a multiplexer and converted to digital values by an analog to digital converter at a rate determined by the computer program. This program is listed in Appendix II.

The digital values are stored in the computer memory and periodically buffered onto magnetic tape. The tape deck is a Kennedy Model 1400R incremental magnetic recorder capable of writing 200 bits per inch at a rate of up to 300 steps per second. The tapes are IBM compatible and thus may be read directly into the CDC-3300 computer at the Oregon State University Computer Center where the data was processed.

The pendulum and gyro were calibrated in the laboratory on a tilt table. Values of analog to digital converter output were tabulated versus the angular deflection of the tilt table from the horizontal. These values were then plotted and a calibration equation derived from a least squares line fitted to the data. A program was written for the CDC-3300 computer which allowed the data, in the form of

A/D output, to be converted back to the angular deflection of gyro and pendulum.

The pressure transducer output was left in an uncalibrated form since the primary interest was in phase shift and frequency content of the data rather than in amplitude of tank moment.

Spectral analysis of the data was accomplished at the Computer Center using a fast Fourier transform program. This method for computing Fourier coefficients was first discussed by Cooley and Tukey (1965). The program is capable of processing up to 1024 values from each of two digitized time series. The output includes the mean, variance, and power-density spectrum for each series. Cross-spectral analysis of the two series gives the co-spectrum, the quadrature spectrum and the coherence squared, phase shift, and transfer function between the two series.

If the records are  $N$  data points in length, the quantities are given at  $(N/2 - 1)$  frequencies between zero and the Nyquist frequency which is given by

$$f_f = \frac{1}{2\Delta T} \text{ Hz}$$

where  $\Delta T$  is the time between samples in seconds.

The program allows the spectral estimates to be band averaged over any number of points to produce a smoothed spectrum. The

results of the analyses were, in most cases, plotted on a Cal Comp plotter interfaced to the CDC-3300 computer.

## EXPERIMENTAL RESULTS

The data presented in this paper were collected during September and October of 1969 on cruises aboard the R/V YAQUINA off the Oregon coast.

The procedure used in each experiment was as follows. A time was chosen when the R/V YAQUINA would be traveling or laying to with seas on the beam for a period of at least 30 minutes. Measurements of ship roll angle and effective waveslope were then made with the anti-roll tank completely empty (or completely full) so that no water transfer would take place and the ship would thus be in the "unstabilized" configuration.

After a sufficient amount of data was taken, the tank was filled (or emptied) to the desired water depth to obtain the "stabilized" configuration. When the ship could again be headed in the desired direction for a period of 30 minutes or more, the measurements were again taken; this time, however, they included tank pressure to monitor the water motion in the tank. Figures 6, 7, and 8 show the spectra obtained from such an experiment.

These measurements were made with the ship heading at either  $000^{\circ}$  or  $180^{\circ}$  with a 6-8 foot swell coming from  $270^{\circ}$ . There was also a 1-2 foot sea coming from  $170^{\circ}$ .

The sensor signals were sampled every 0.514 seconds and the

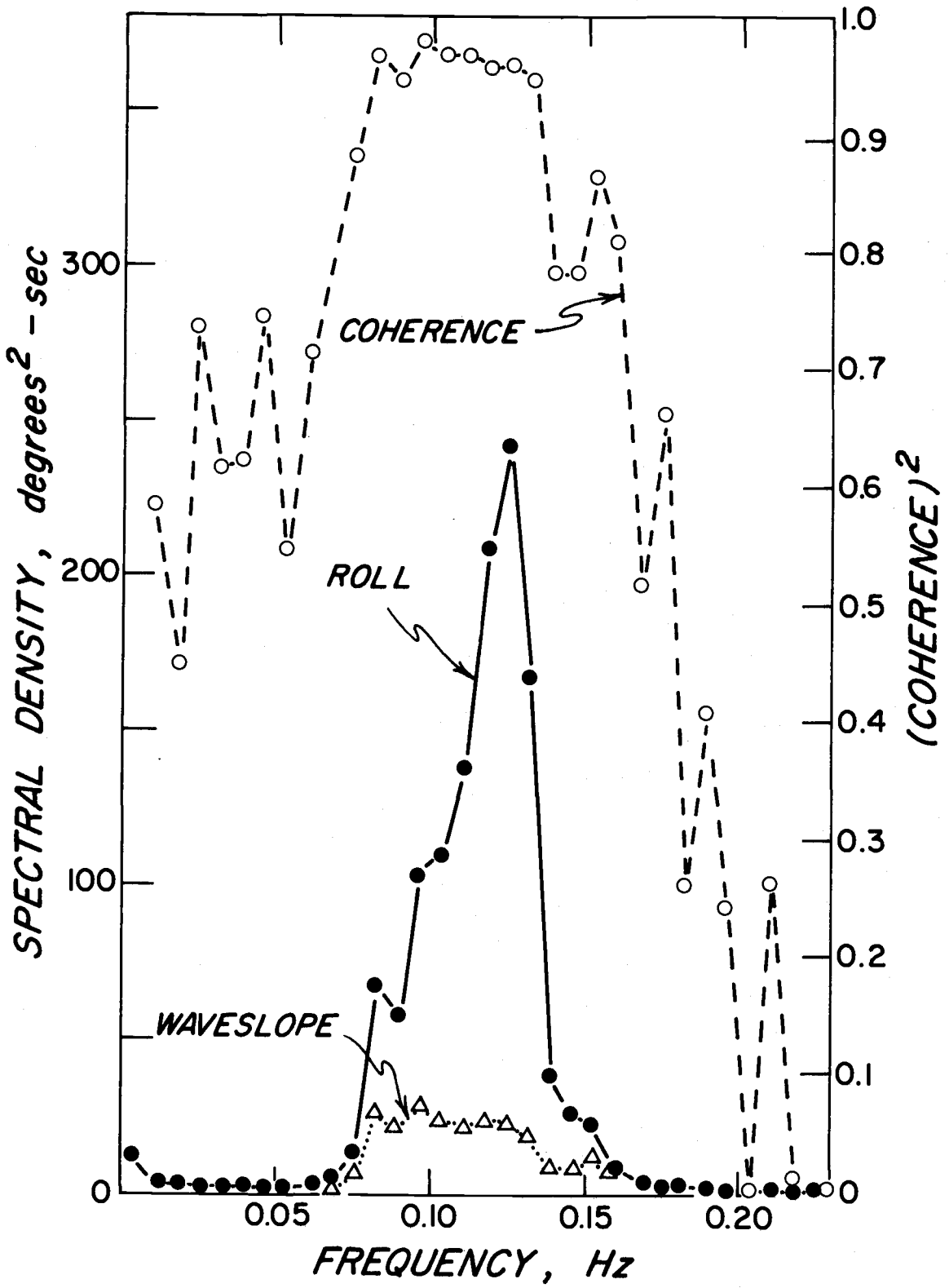

Figure 6. Spectral densities and coherence - Record 1131 (unstabilized).

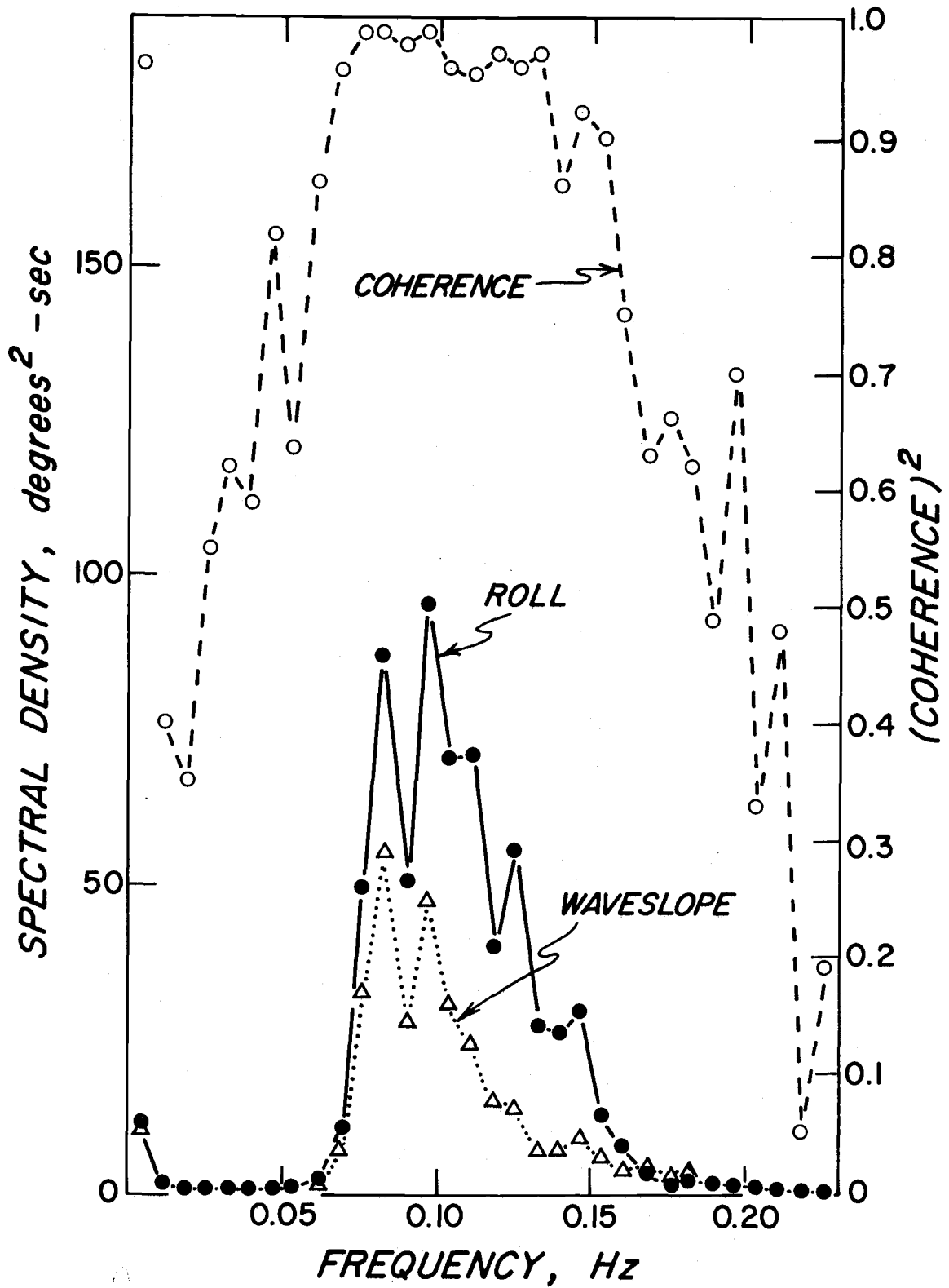

Figure 7. Spectral densities and coherence - Record 1136 (stabilized).

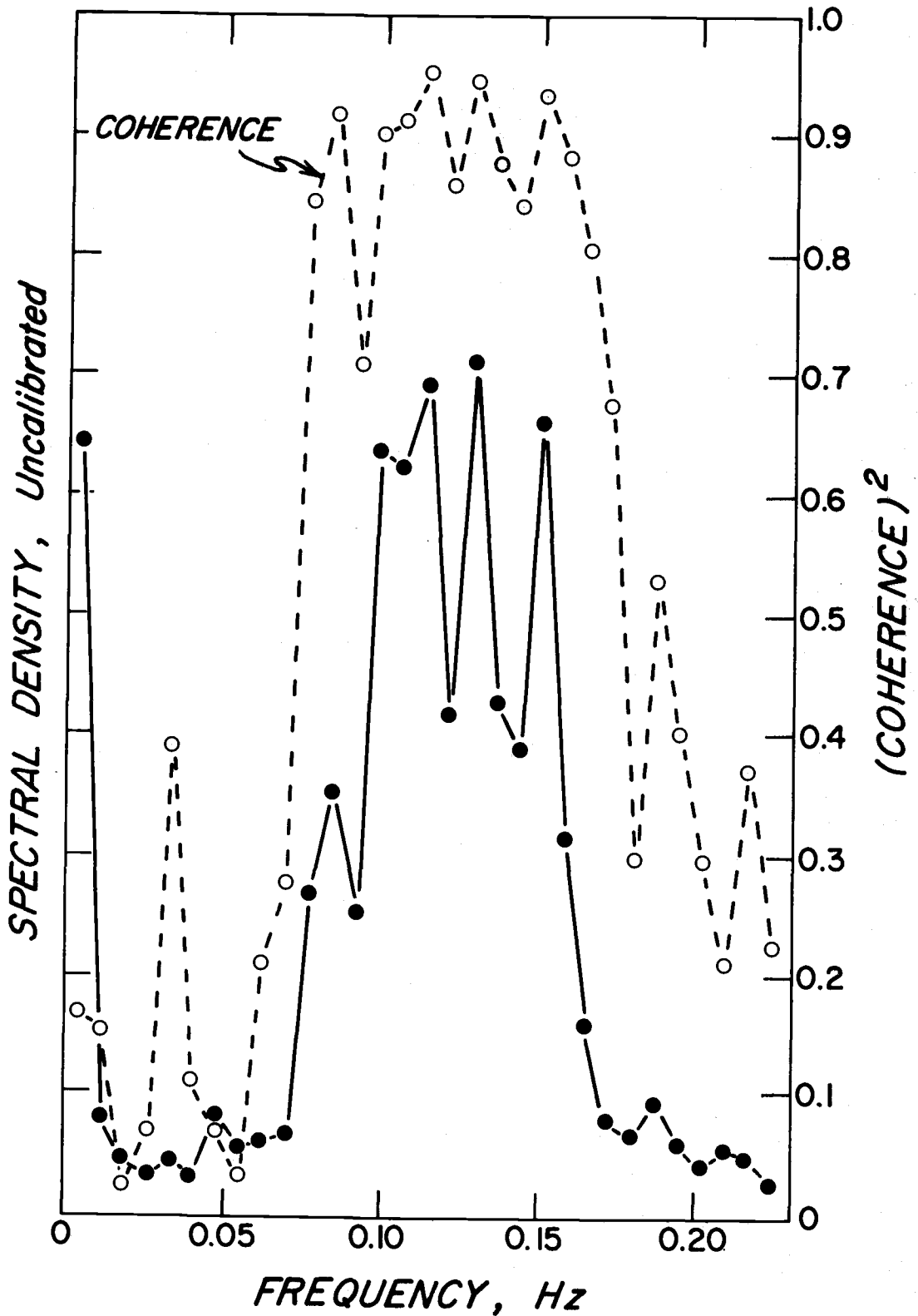

Figure 8. Tank pressure spectral density and coherence between tank pressure and roll - Record 1136.



data was pre-filtered by averaging every 4 samples so that the time between data points in the series was 2.056 secs which gave a Nyquist frequency of 0.239 Hz. The resulting time series (1024 data points) was thus 34 minutes in length. Other experiments were made with varying sampling rates and resulting record lengths of between 8.5 minutes and 34 minutes. These were considered sufficient since the ship rolls and waves of interest were of the order of 6-12 seconds in period. The pre-filtering was done in order to minimize the chances of high frequency noise being folded into the spectra. Experiments made with Nyquist frequencies of up to 0.961 Hz never gave any indication of significant high frequency noise present in the measurements. The spectra produced by the fast Fourier transform program were band averaged over 15 spectral estimates. This resulted in smoothed spectra with 30 degrees of freedom.

Figure 6 shows the input (effective waveslope) and output (roll angle) spectra with the ship in the unstabilized configuration. The coherence squared between the spectra is also plotted in Figure 6. Figure 7 shows a similar input and output spectra and coherence with the ship in the stabilized configuration. Figure 8 shows the tank pressure spectrum obtained at the same time and the coherence squared between roll and tank pressure.

The results of the spectral analyses of all data used in this paper are shown in Appendix III along with data concerning sampling

procedures such as sampling rate, Nyquist frequency, and type of prefiltering.

Figure 9 shows the results of an experiment designed to compare the effective waveslope spectrum as measured by the pendulum aboard the R/V YAQUINA to a waveslope spectrum obtained by another method. The method used was to derive the slope spectrum from a measured wave height spectrum. If we consider a one-dimensional wave with infinitely long crest, according to linear first-order wave theory, the height is given by

$$\eta = \sum_{i=1}^N a_i \sin(k_i x - \sigma_i t), \quad N \text{ large}$$

where the wavelength  $L = \frac{2\pi}{k}$ , and the wave period  $T = \frac{2\pi}{\sigma}$ .

Thus the height spectrum is proportional to  $a_i^2$ . To obtain the slope we take the partial derivative with respect to  $x$ :

$$\frac{\partial \eta}{\partial x} = \sum_{i=1}^N a_i k_i \cos(k_i x - \sigma_i t)$$

So the spectrum is proportional to  $a_i^2 k_i^2$ . In deep water we know

$$\sigma_i^2 = g k_i$$

so

$$k_i^2 = \frac{\sigma_i^4}{g^2}$$

WAVE HEIGHT SPECTRAL DENSITY,  
*Uncalibrated*

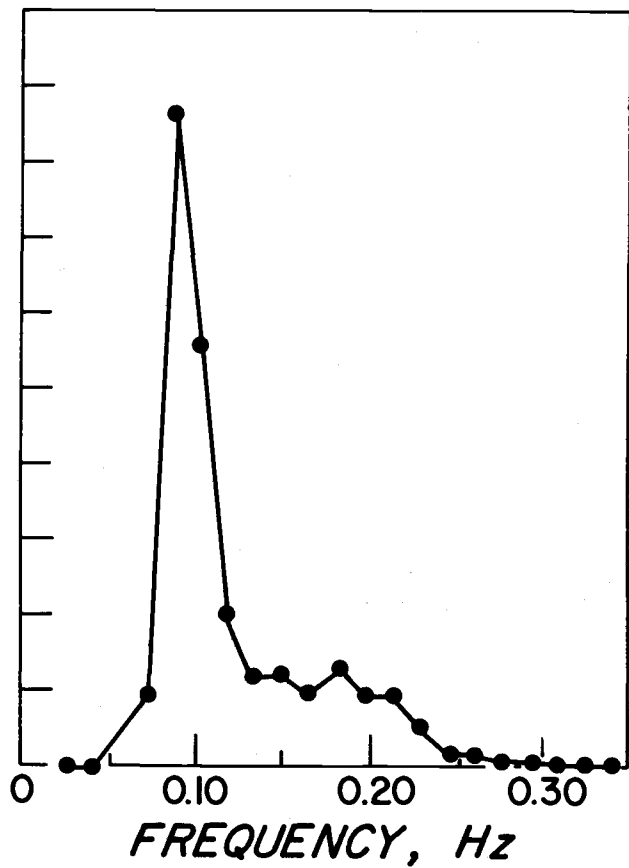

WAVESLOPE SPECTRAL DENSITY,  
*Uncalibrated*

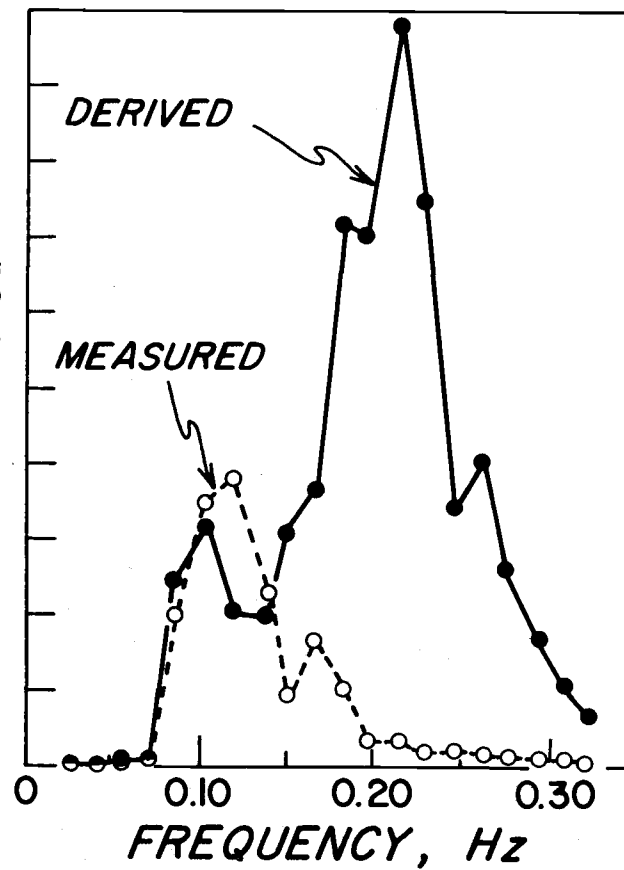

Figure 9. Comparison of measured and derived waveslope spectra.

and the slope spectrum becomes proportional to

$$\frac{a_i^2 \sigma_i^4}{g^2} = \frac{(2\pi \omega_i)^4 a_i^2}{g^2}$$

We see that if we multiply the height spectrum by  $\omega_i^4$  we obtain a spectrum which differs from slope spectrum by a constant only.

The left-hand plot in Figure 9 shows a height spectrum obtained by mounting a pressure transducer (of the same type that was used to measure tank pressure) 15 feet below mean water level on a stable platform in deep water off the Oregon coast. The platform used was Oregon State University's Totem, a 200 foot long cylindrical buoy which floats in the vertical position with 30 feet extending above mean water level. The vertical motions of Totem are small, thus making it an ideal platform from which to measure wave motions.

The right-hand plot shows the slope spectrum derived from the height spectrum by the method shown above and an effective wave-slope spectrum obtained, at the same time, aboard the R/V YAQUINA.

Figure 10 shows plots of the phase relationships, as obtained from the cross-spectral analysis, between waveslope and ship roll in the unstabilized and stabilized configurations and between ship roll and roll tank pressure when the tank was operating.

Figure 11 shows the transfer functions obtained from the two experiments conducted with the ship in the unstabilized configuration,

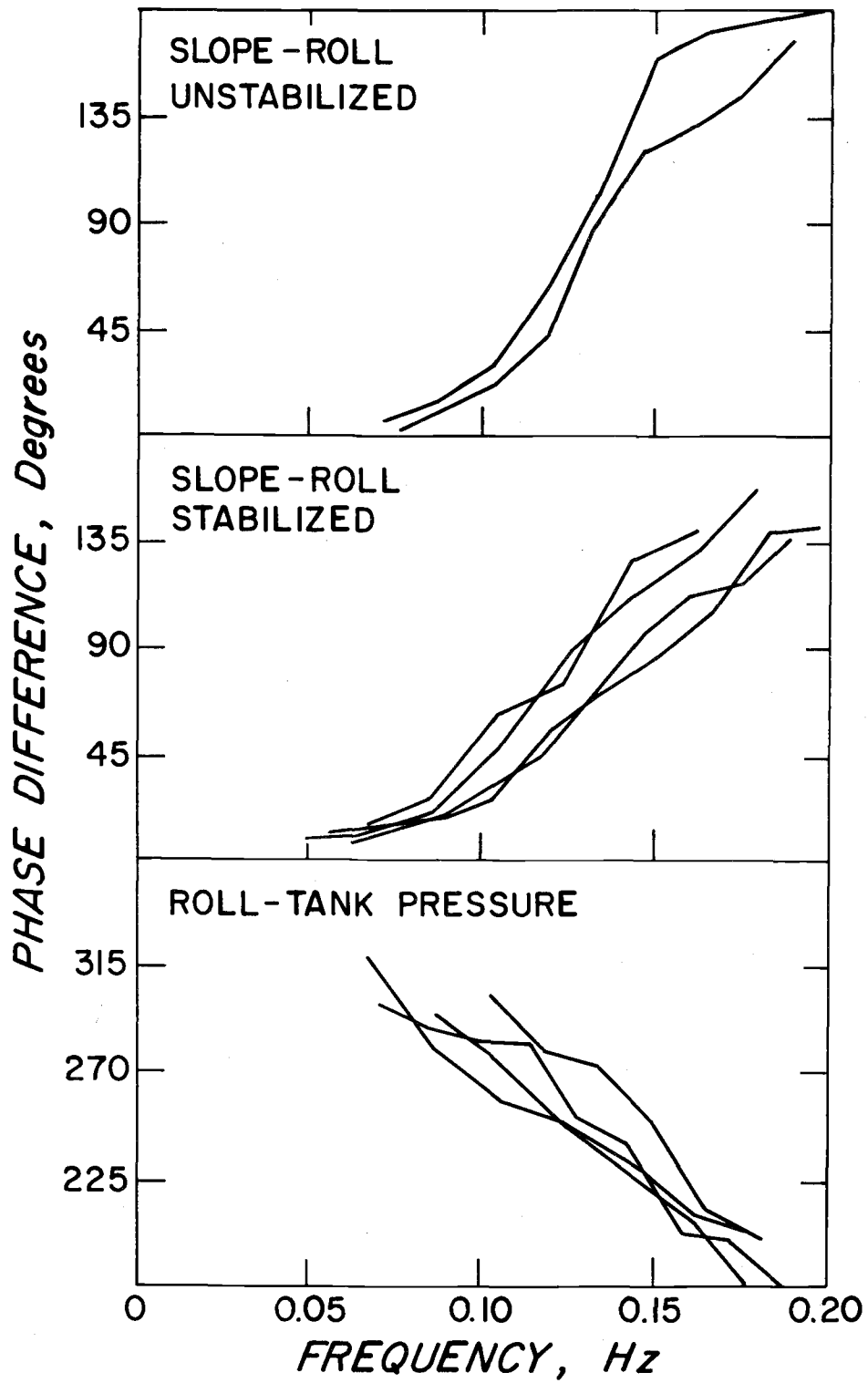

Figure 10. Phase differences.

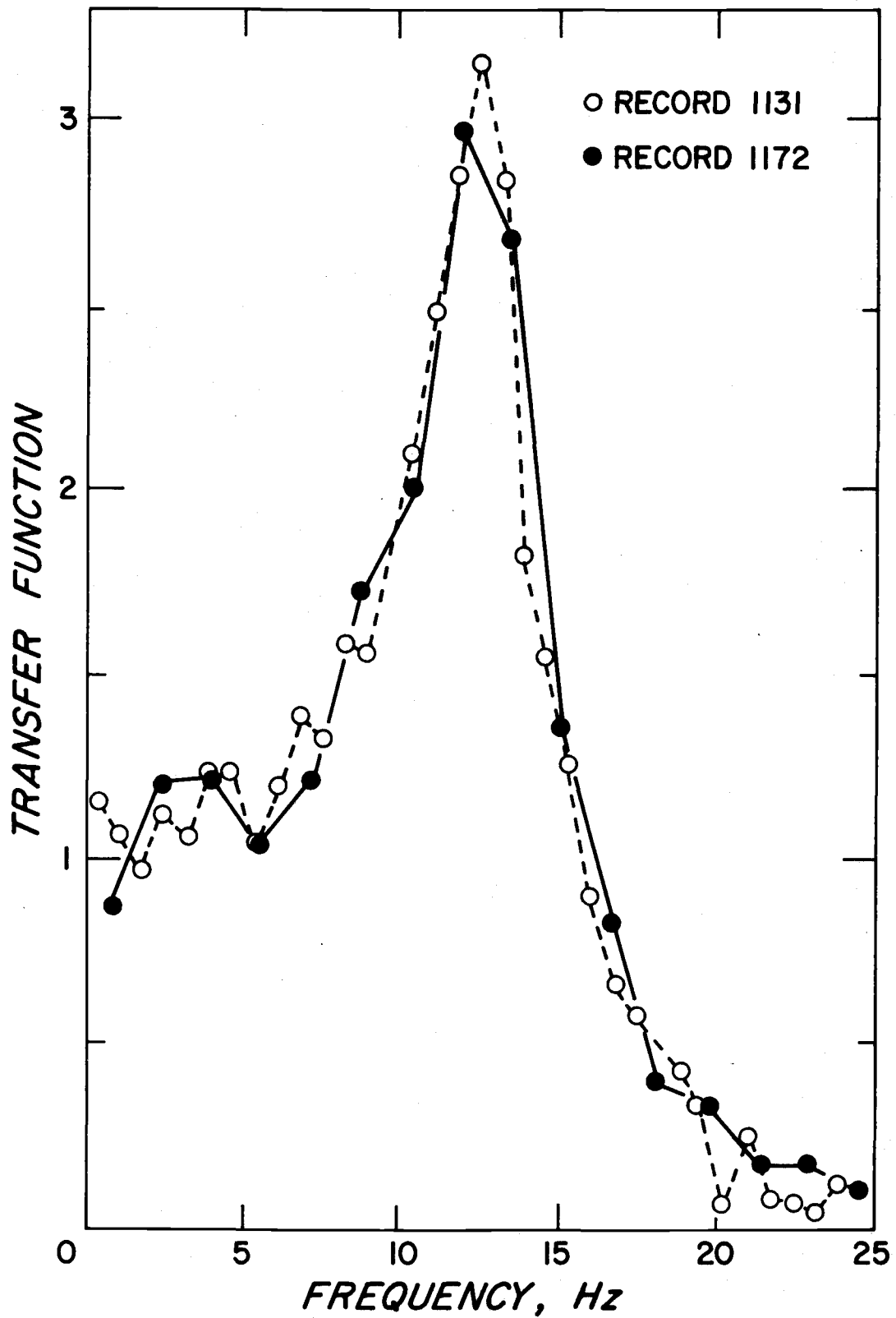

Figure 11. Transfer functions - unstabilized configuration.

and Figure 12 shows the transfer functions for four experiments conducted with the ship in the stabilized configuration. Records 1136 and 1173 were taken when the tank was at the design water level of 2.25', and records 1133 and 1134 were taken with water levels of 1.25' and 3.25' respectively in order to determine the effect of varying water level on tank performance.

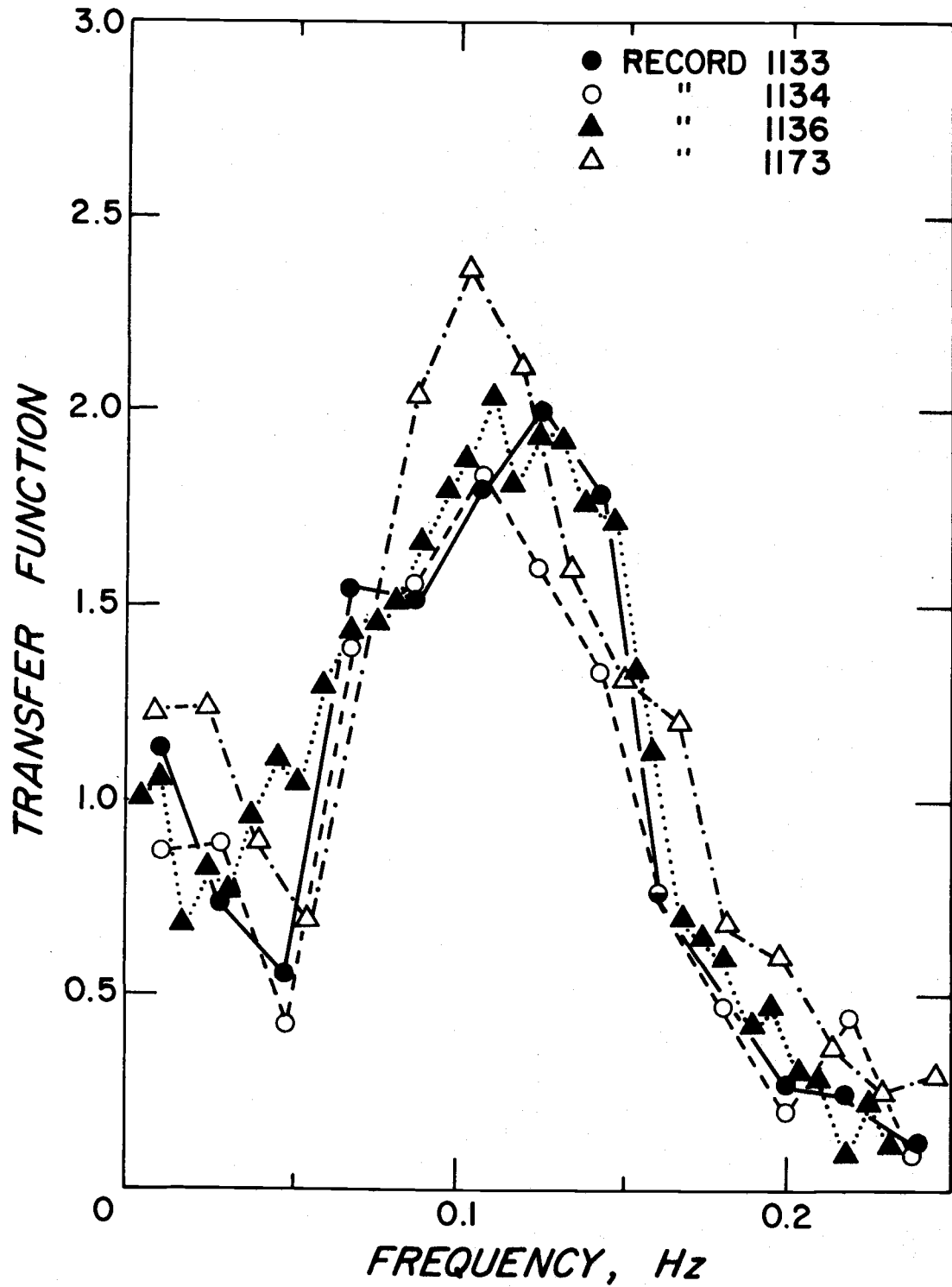

Figure 12. Transfer functions - stabilized configuration.



## DISCUSSION

Figure 9 shows waveslope spectra calculated both from pendulum measurements aboard the R/V YAQUINA and wave height measurements. At first glance the spectra appear to be very different; however, the major portion of the energy in the spectra derived from the wave height measurements appears at a frequency of about 0.22 Hz which corresponds to a wave of 4.5 second period. This spectrum contains energy from waves coming from all directions whereas the R/V YAQUINA, being aligned with the crests of the largest waves present, will roll primarily in response to these large waves, and the slope spectrum measured aboard ship will not contain the energy at the higher frequencies. However, the peak energy in the measured spectrum does occur at a frequency very close to the frequency of the smaller peak of the derived spectrum. It would appear, then, that the pendulum does an adequate job of measuring the slopes of the waves in the frequency range in which we are interested.

Figure 13 shows average transfer functions computed from the transfer functions of Figures 11 and 12. It can be seen that the effect of the anti-roll tank is to dissipate much of the energy near the resonance peak of about 0.12 Hz. The peak value for the transfer function is reduced from 2.92 in the unstabilized case to 1.99 in the stabilized case--a reduction of 32%. If we apply these average transfer functions

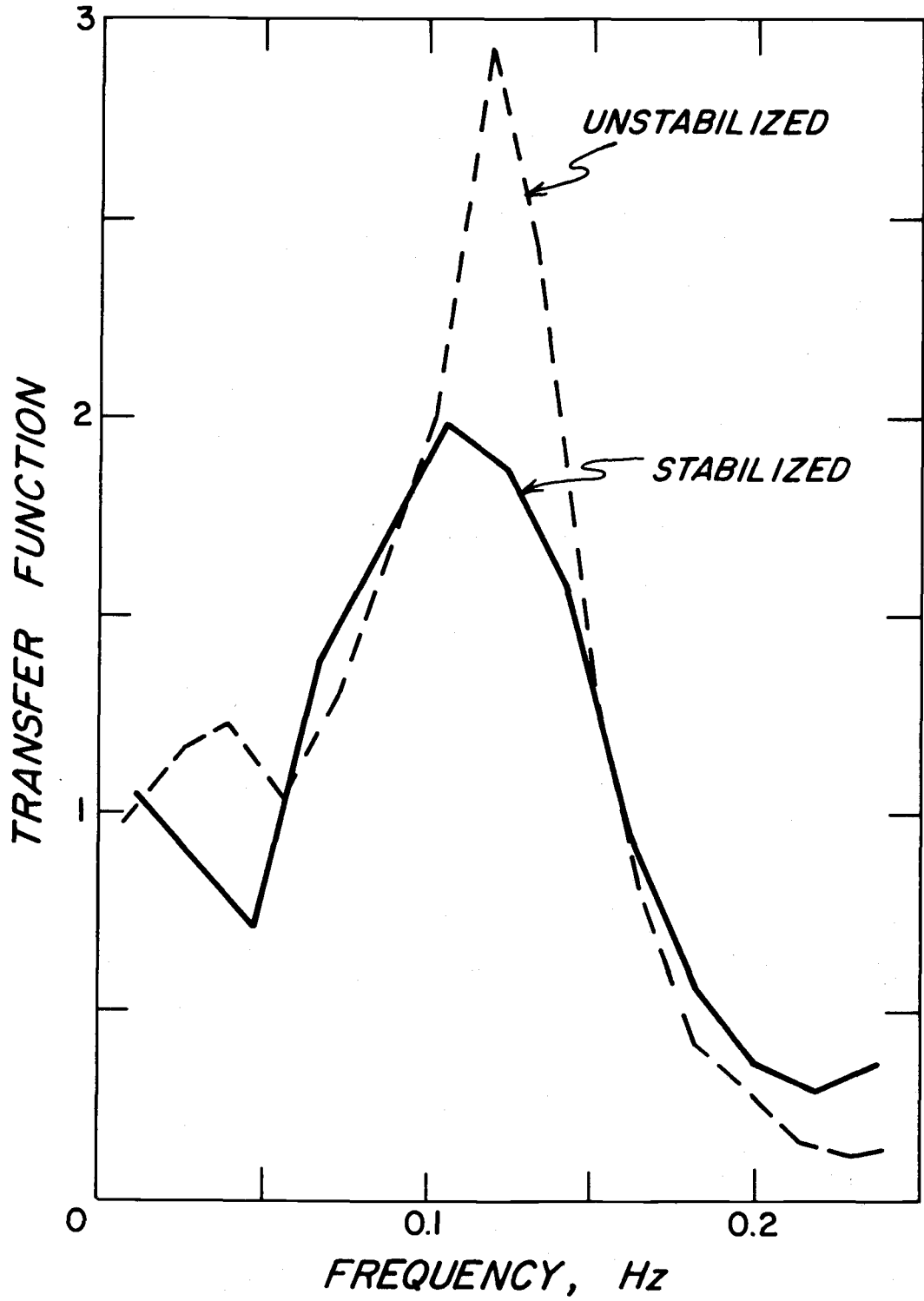

Figure 13. Average transfer functions.

to a typical input waveslope spectra and determine the area of the resulting output spectra by numerical integration, we can determine a value for the average reduction in RMS roll from the unstabilized to the stabilized case. Using the input spectra of record no. 1172 (see Figure 9) a reduction of 38% in RMS roll was noted. It is felt that this figure is a meaningful measure of the effectiveness of the R/V YAQUINA's anti-roll tank.

The decrease in peak transfer function noted above takes place because of energy dissipated by turbulence in the anti-roll tanks. We might think of this energy dissipation as being a result of an increased system damping factor. In Figure 14, the solid lines are the average transfer functions of the R/V YAQUINA in the unstabilized and stabilized configurations. In this curve the transfer function is converted to db amplitude which is defined as

$$\text{db} = 20 \log_{10} \frac{|H(\omega)|}{|H(\omega)|_{\omega=0}}$$

This is plotted as a function of a dimensionless frequency  $U = \omega/\omega_n$  where  $\omega_n$  is the resonant frequency. The dashed lines are transfer functions obtained from the solution of the differential equation for a second-order mechanical system. If the system equation is

$$I_{\phi} \ddot{\phi} + N_{\phi} \dot{\phi} + R_{\phi} \phi = K(t)$$

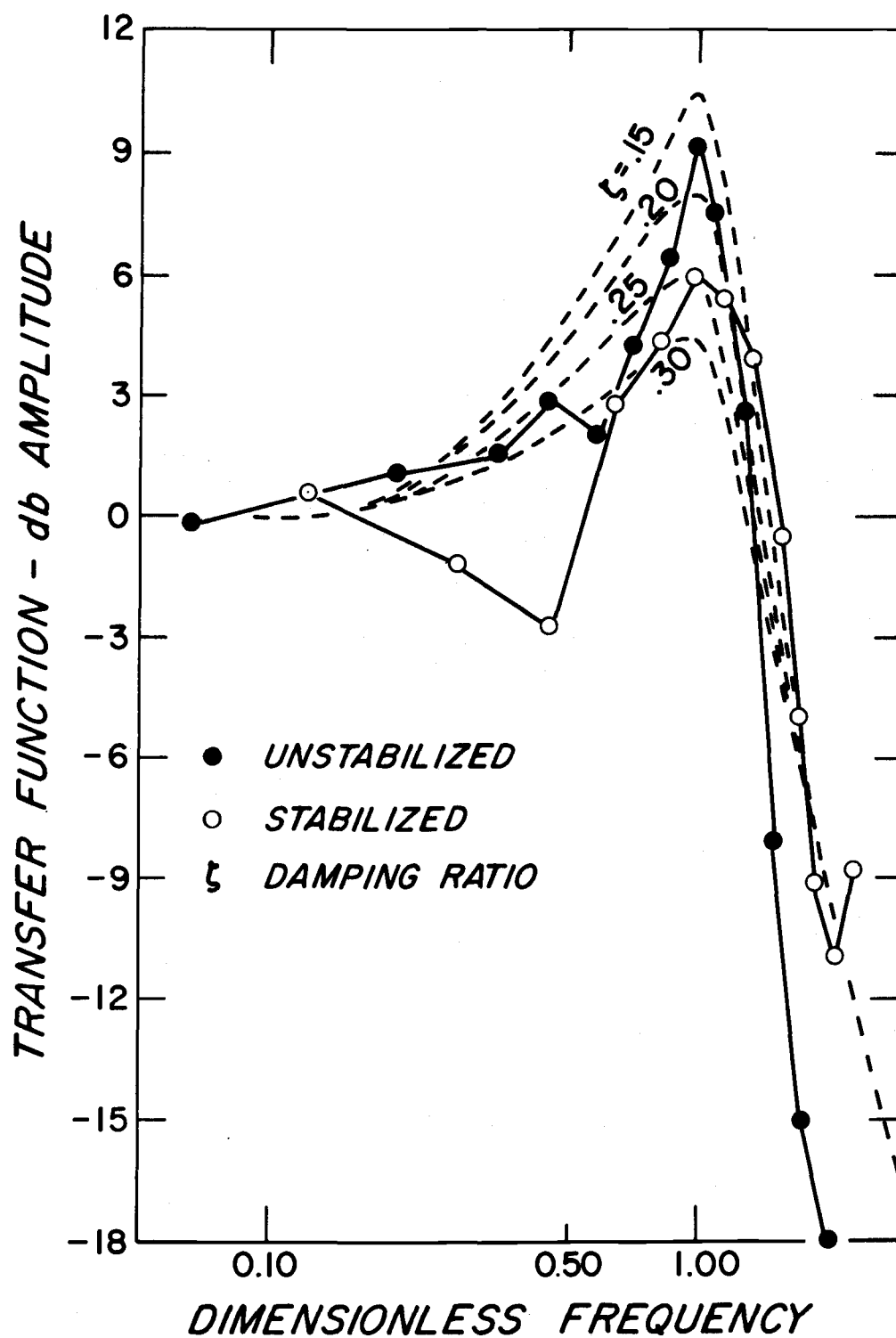

Figure 14. Amplitude of second-order transfer functions as a function of damping ratio.

then the dimensionless damping ratio  $\zeta$  is defined as

$$\zeta = \frac{N_{\phi}}{\sqrt{R_{\phi} I_{\phi}}}$$

It can be seen from Figure 14 that, at the resonant frequency, the effect of the roll tanks is to increase the damping ratio which is desirable. However, at frequencies above  $1.2 \omega_n$  it appears that the effect is reversed.

Records 1133 and 1134 were obtained with the tank water level one foot below and one foot above design water level, respectively, with the intention of determining what effect, if any, a change in water level would have on tank performance. It appears from Figure 12 that it is difficult to detect any meaningful difference in the transfer functions obtained from these two records. Vasta et al. (1961) states that stabilizer performance is relatively insensitive to tuning due to the large damping and out-of-phase moment (see Appendix I) obtained in the flume tank. It seems that this is the case with the R/V YA-QUINA's tank.

For any linear constant parameter system the natural frequency is defined as the frequency at which the phase difference between the input and the output equals  $90^{\circ}$ . It can be seen from Figure 10 that the phase difference between waveslope and roll angle varies from 0 to  $180^{\circ}$  as the frequency increases. If we average the values of

frequency for a  $90^\circ$  phase difference, we obtain natural frequencies of 0.131 Hz and 0.138 Hz (periods of 7.6 sec. and 7.25 sec.) for the un-stabilized and stabilized configuration, respectively. The third plot shows the phase difference between roll and tank movement. These values range from  $360^\circ$  to  $180^\circ$  rather than from 0 to  $180^\circ$ . This  $180^\circ$  ambiguity is unimportant since it results from the fact that the pressure transducer used to measure the tank water transfer could be placed at either end of the tank, and the tank moment measured at these two points will be  $180^\circ$  apart in phase. Visual observation of a sight glass on the roll tank confirmed that the water was acting as it should; that is the water level was greatest on the "rising" side of the ship. The natural frequency of the tank as determined from this plot is 0.111 Hz ( a period of 9.1 seconds). If we average the frequencies at which the peak energy is found in the tank pressure spectra, we obtain a frequency of 0.132 Hz ( a period of 7.6 sec.) It is felt that the scatter in these plots is such that no meaningful conclusions can be drawn concerning the effect of the tank on the natural frequency of the ship. However, it does seem clear that the tank is properly tuned, that is, its natural frequency is very close to that of the ship.

This study has shown, therefore, that the passive anti-roll tanks do have a significant and beneficial effect on the rolling performance of the R/V YAQUINA.

It should be remembered, however, that all tests were made with seas approaching on the beam and we can, therefore, make no conclusions about the tanks effectiveness in reducing yaw-heel rolling, especially very long period rolling resulting from following seas.

## BIBLIOGRAPHY

- Burger, W. and A. G. Corbet. 1966. Ship stabilizers. Oxford, Pergamon Press, 184 p.
- Chadwick, J. H. 1955. On the stabilization of roll. Transactions of the Society of Naval Architects and Marine Engineers 63: 237-280.
- Chadwick, J. H. and K. Klotter. 1954. On the dynamics of anti-rolling tanks. Schiffs-technik 8: 85-103.
- Cooley, J. W. and J. W. Tukey. 1965. An algorithm for the machine calculation of complex Fourier series. Mathematics of Computation 19: 297-301.
- Van den Bosch, J. J. 1967. A free-surface tank as an anti-rolling device for fishing vessels. Fishing Vessels of the World, p. 159-169.
- Van den Bosch, J. J. and J. H. Vugts. 1966. On roll damping by free-surface tanks. Transactions of the Royal Institution of Naval Architects, p. 345-361.
- Vasta, J., et al. 1961. Roll stabilization by means of passive tanks. Transactions of the Society of Naval Architects and Marine Engineers 69: 411-460.
- Weinblum, G. and M. St. Denis. 1950. On the motions of ships at sea. Transactions of the Society of Naval Architects and Marine Engineers 58: 184-248.



## APPENDICES

## APPENDIX I.

## THE OPERATION OF THE PASSIVE ANTI-ROLL TANK

The purpose of this appendix is to provide the reader with a qualitative understanding of the operation of the passive anti-roll tank rather than to attempt a rigorous theoretical treatment. The discussion follows, in general form, that in Van den Bosch (1967). That paper should be consulted for additional information concerning the comparison of theoretical computations with the results of model tests. As previously stated, a complete theoretical treatment of the problem may be found in Chadwick and Klotter (1954).

If we refer to Figure 1, we can see that the rolling motion of the ship provides potential energy which causes the water in the tank to travel downhill. If the natural frequency of the tank is approximately the same as that of the ship, the water will always be deeper in the end of the tank on the rising side of the ship. The ship has to do work to lift this water, and there is thus an energy transfer from the ship to the water in the tank. The kinetic energy gained by the water in the tank is converted to heat through the turbulent motions of the water.

If we use a damped mass-spring system as a model for the rolling ship, the equation of motion is given by:

$$I_{\phi} \ddot{\phi} + N_{\phi} \dot{\phi} + R_{\phi} \phi = K(t)$$

where  $I_{\phi}$  is the roll moment of inertia,  $N_{\phi}$  is the roll damping coefficient,  $R_{\phi}$  is the roll righting coefficient and  $K(t)$  is the exciting moment. If the exciting moment varies sinusoidally, then the resulting motion also varies sinusoidally, and it can be shown that the natural frequency for such a system is given by

$$\omega_n = \frac{R_{\phi}}{I_{\phi}}$$

At this frequency, the motion lags the driving moment by  $90^{\circ}$ , and the transfer function can become very large. As we saw previously, a measure of damping is the dimensionless damping ratio:

$$\zeta = \frac{N_{\phi}}{\sqrt{I_{\phi} R_{\phi}}}$$

At resonance the transfer function becomes

$$H(\omega_n) = \frac{1}{\zeta}$$

Referring to Figure A.1 and the above relations, we can see the effect of changing any of the coefficients of the differential equations.

If we consider the tank moment to be an external moment applied to the ship and varying sinusoidally with the same frequency as the rolling motion, it may be expressed as

$$M(t) = M_a \sin(\omega t + \epsilon_t)$$

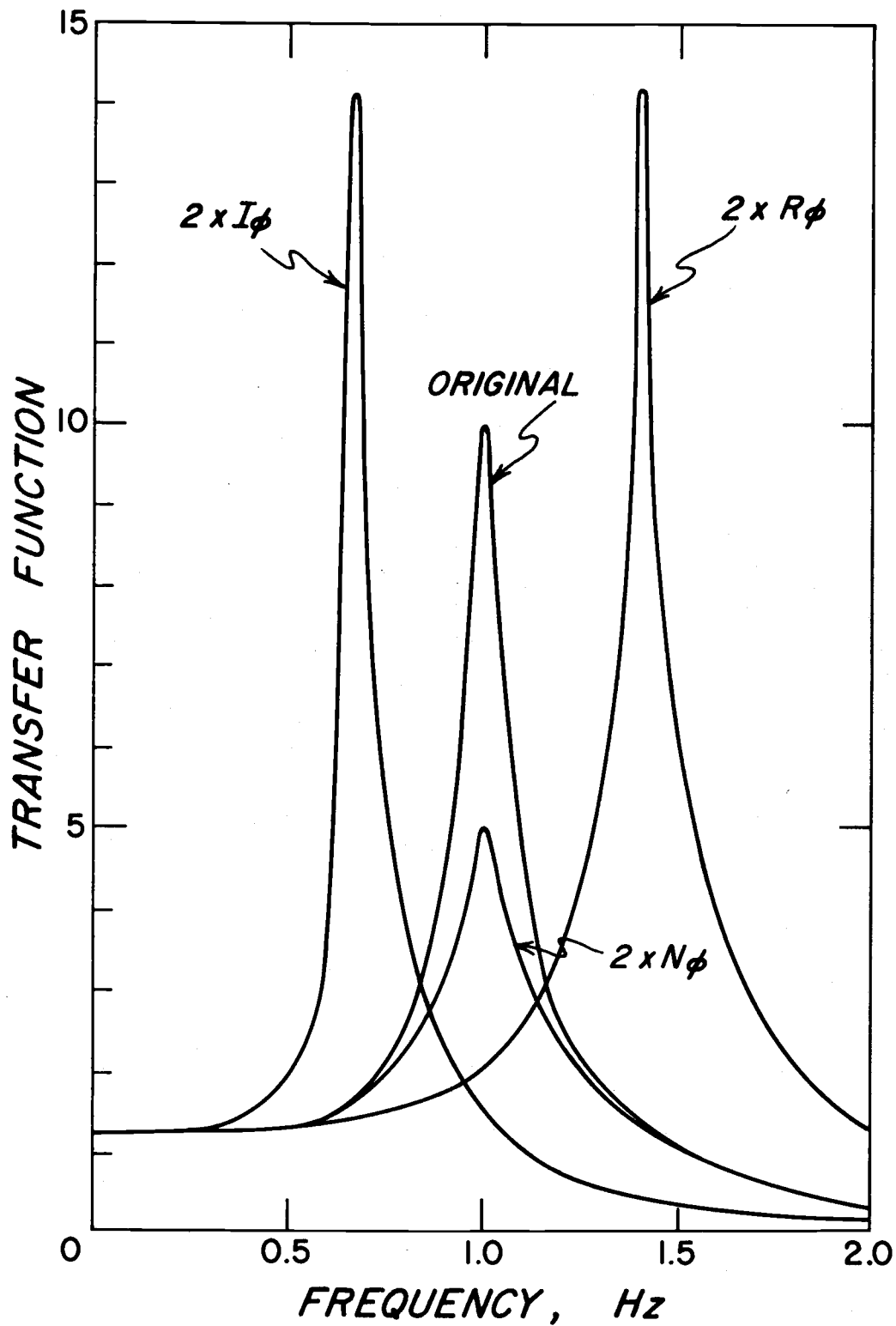

Figure A.1. Influence of coefficients of equations of motion (van den Bosch, 1967).

where  $\epsilon_t$  is the phase difference between tank moment and roll.

The tank moment may be resolved into two components, one in phase with the roll, and one  $90^\circ$  out of phase:

$$M = M_a \sin \omega t \cos \epsilon_t + M_a \cos \omega t \sin \epsilon_t$$

Figure A. 2 shows the general form of these components as determined from model studies. If we assume that the driving moment due to waves is of the form

$$K(t) = K_a \sin(\omega t + \epsilon_\phi)$$

where  $\epsilon_\phi$  is the phase difference between wave moment and roll.

Then the equation of motion becomes

$$I_\phi \ddot{\phi} + N_\phi \dot{\phi} + R_\phi \phi = K_a \sin(\omega t + \epsilon_\phi) + M_a \sin(\omega t + \epsilon_t) \quad (\text{A. 1})$$

If we resolve the tank moment into its components and if the ship roll angle is

$$\phi(t) = \phi_a \sin \omega t$$

Equation (A. 2) becomes

$$\begin{aligned} & (R_\phi - I_\phi \omega^2 - \frac{M_a}{\phi_a} \cos \epsilon_t) \sin \omega t + (N_\phi \omega - \frac{M_a}{\phi_a} \sin \epsilon_t) \cos \omega t \\ &= \frac{K_a}{\phi_a} \sin(\omega t + \epsilon_\phi) \end{aligned}$$

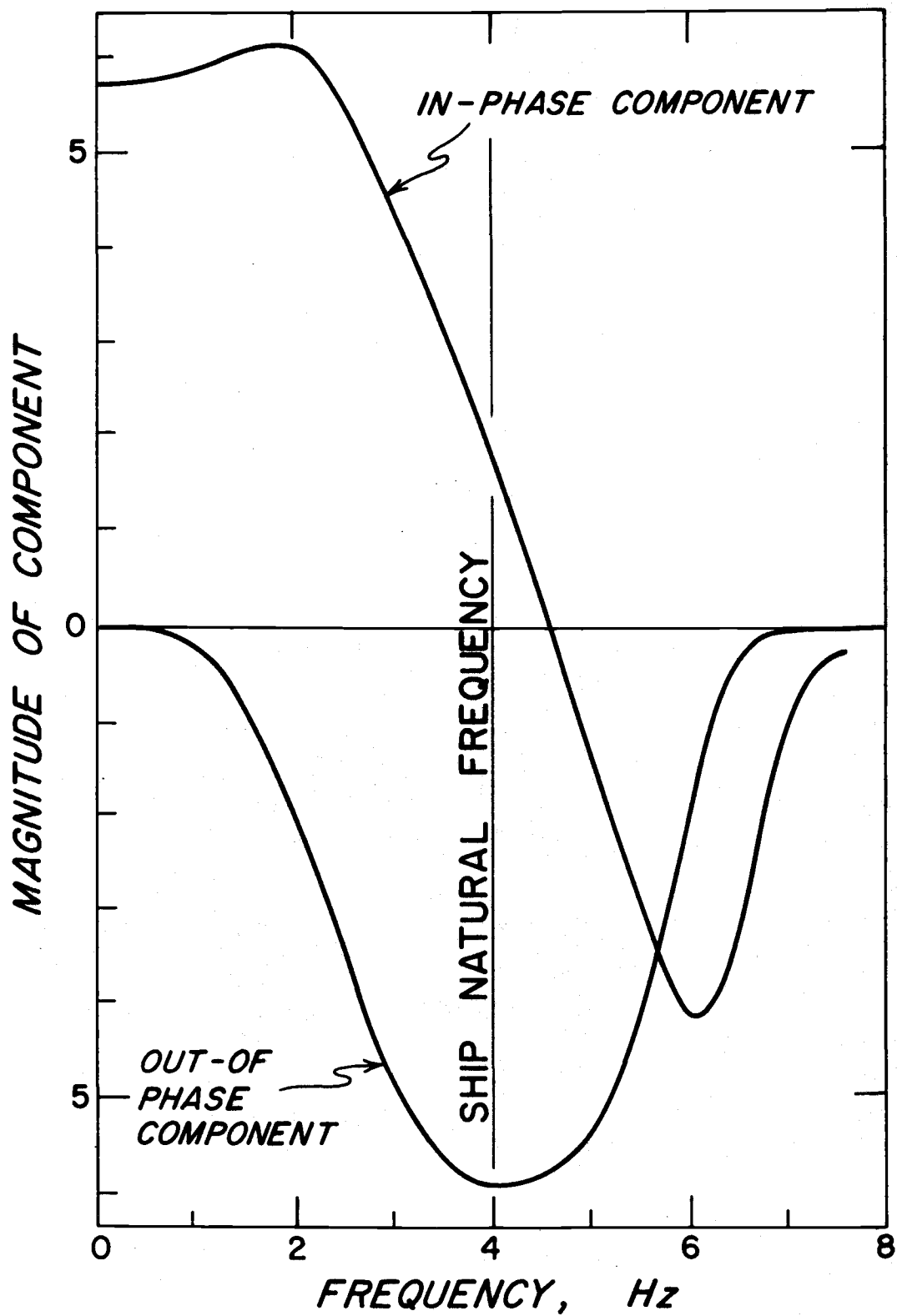

Figure A. 2. Components of tank moment (van den Bosch, 1967).

If we compare this to Equation (A.1) (with a similar substitution for  $\phi$ ),

$$(R_{\phi} - I_{\phi} \omega^2) \sin \omega t + N_{\phi} \cos \omega t = \frac{K_a}{\phi_a} \sin(\omega t + \epsilon_{\phi})$$

we can see that when the tank moment lags behind the roll, i. e. negative values of  $\epsilon_t$ , the effect of the tank moment is to increase the damping factor,  $N_{\phi}$ .

Visual observation of the tank, along with reference to Figure 11, confirms that tank moment does lag behind roll throughout the entire frequency range considered.

Similarly, the in-phase component of the tank moment will be positive at frequencies below the ship's natural frequency and negative at greater frequencies. At the lower frequencies the positive values of this component have the effect of increasing  $I_{\phi}$  and as we saw in Figure A.1, this would tend to decrease the natural frequency of the system. Therefore, the "stabilized" transfer function in Figure A. e has its highest peak below that of the unstabilized transfer function. Theoretical studies predict, in some cases, a second peak in the transfer function at frequencies higher the unstabilized natural frequency. This peak, as shown in Figure A.3, is apparently a result of the negative in-phase component augmenting the influence of  $R_{\phi}$ . However, reference to Chadwick (1954) shows that, for large values of tank damping, this secondary peak may not appear and there may be

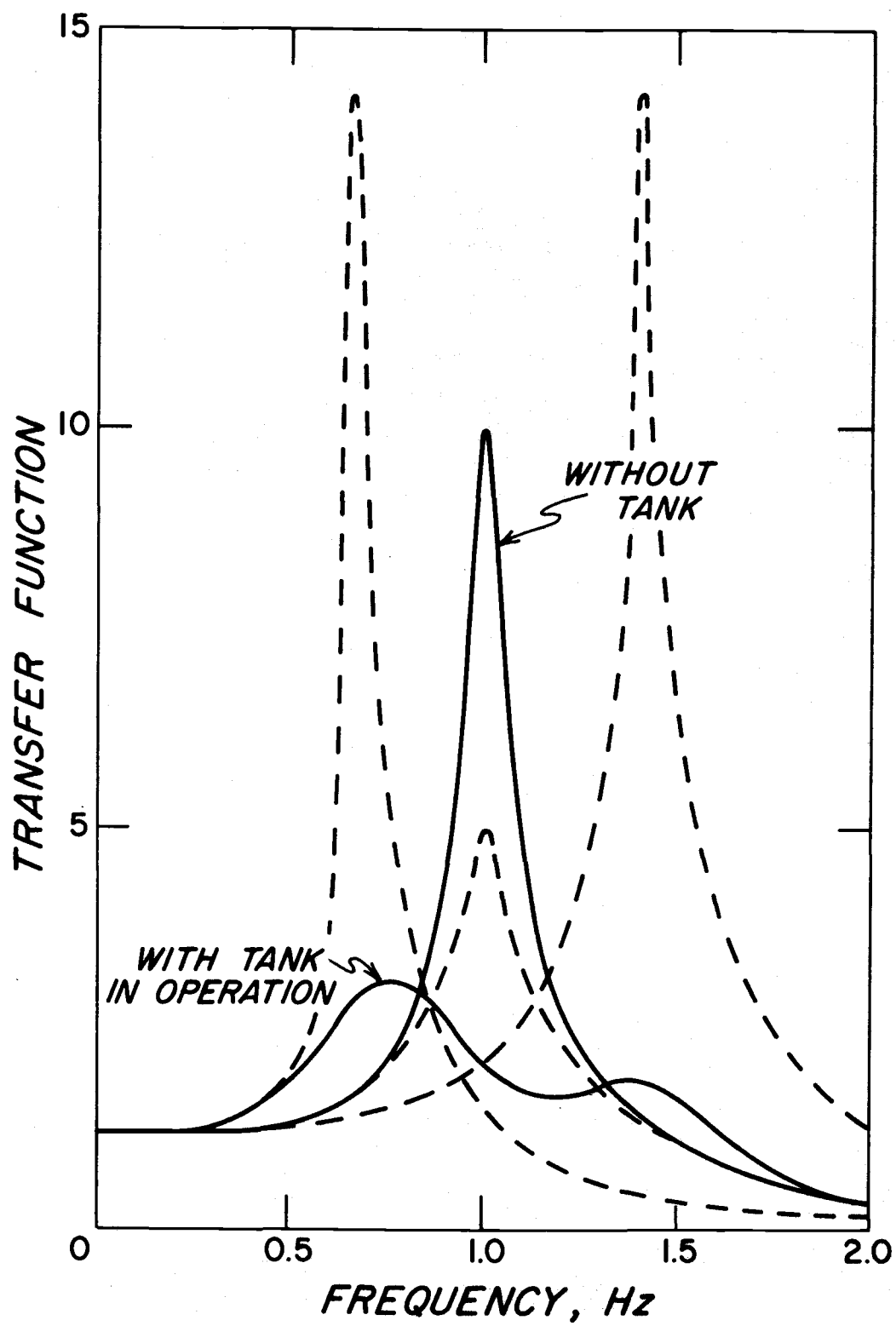

Figure A. 3. Schematic presentation of tank influence (van den Bosch, 1967).



little change in the ship's natural frequency between the unstabilized and stabilized cases. The transfer functions measured aboard the YAQUINA seem to indicate that this is the case.

## APPENDIX II

## DATA ACQUISITION PROGRAM

This program is written for the PDP-8/S computer used in the data acquisition system as described previously. The mnemonics shown below are utilized by the PAL III Assembler to produce a machine language program, as indicated by the octal content of the registers. The program allows the sampling of up to 12 different analog signals at a pre-determined rate. The signals are sampled sequentially causing the data to be staggered a small amount in time. The program allows simple pre-filtering of the data; that is a pre-determined number of samples from each channel being sampled may be averaged. This averaged value is then stored in the computer memory. The amount of data which can be stored is, of course, limited by the size of the memory (4096 words), so when the memory is filled, data collection ceases for a short time while the program buffers the contents of the memory onto magnetic tape. If a long time series is desired, this buffering operation causes undesirable gaps in the series. However, the sampling rates and series lengths utilized in this study allowed uninterrupted time series.

| REGISTER ADDRESS | OCTAL CONTENT | MNEMONIC INSTRUCTION |
|------------------|---------------|----------------------|
| 0015             | 0             | AUTOAD, 0            |
| 0177             | 7300          | BEG , CLA CLL        |
| 0200             | 1366          | TAD NUMCHN           |
| 0201             | 7041          | CIA                  |
| 0202             | 3373          | DCA CHNCNT           |
| 0203             | 1374          | TAD MUX              |
| 0204             | 3377          | DCA STORAD           |
| 0205             | 3777          | DCA I STORAD         |
| 0206             | 2377          | ISZ STORAD           |
| 0207             | 2373          | ISZ CHNCNT           |
| 0210             | 5205          | JMP .-3              |
| 0211             | 1365          | TAD NUMAV            |
| 0212             | 7041          | CIA                  |
| 0213             | 3372          | DCA CHNUMAV          |
| 0214             | 1371          | TAD ADRES            |
| 0215             | 3015          | DCA AUTOAD           |
| 0216             | 1367          | TAD NUMSMP           |
| 0217             | 7041          | CIA                  |
| 0220             | 3376          | DCA WRDCNT           |
| 0221             | 5230          | JMP 230              |
| 0222             | 1365          | TAD NUMAV            |
| 0223             | 7041          | CIA                  |
| 0224             | 3372          | DCA CNUMAV           |
| 0225             | 7000          | NOP                  |
| 0226             | 6121          | GO , 6121            |
| 0227             | 5226          | JMP .-1              |
| 0230             | 7300          | CLA CLL              |
| 0231             | 1370          | TAD TIME             |
| 0232             | 7041          | CIA                  |
| 0233             | 7040          | CMA                  |
| 0234             | 6126          | 6126                 |
| 0235             | 6135          | 6135                 |
| 0236             | 7300          | CLA CLL              |
| 0237             | 1366          | TAD NUMCHN           |
| 0240             | 7041          | CIA                  |
| 0241             | 3373          | DCA CHNCNT           |
| 0242             | 1374          | TAD MUX              |
| 0243             | 3375          | DCA MUXAD            |
| 0244             | 1375          | BOO , TAD MUXAD      |
| 0245             | 6546          | 6546                 |
| 0246             | 4275          | JMS ATOD             |

| REGISTER ADDRESS | OCTAL CONTENT | MNEMONIC INSTRUCTION |
|------------------|---------------|----------------------|
| 0247             | 1775          | TAD I MUXAD          |
| 0250             | 3775          | DCA I MUXAD          |
| 0251             | 2375          | ISZ MUXAD            |
| 0252             | 2375          | ISZ CHNCNT           |
| 0253             | 5244          | JMP BOO              |
| 0254             | 2372          | ISZ CNUMAV           |
| 0255             | 5226          | JMP GO               |
| 0256             | 1366          | STORE , TAD NUMCHN   |
| 0257             | 7041          | CIA                  |
| 0260             | 3373          | DCA CHNCNT           |
| 0261             | 1374          | TAD MUX              |
| 0262             | 3377          | DCA STORAD           |
| 0263             | 1777          | FLT , TAD I STORAD   |
| 0264             | 3415          | DCA I AUTOAD         |
| 0265             | 3777          | DCA I STORAD         |
| 0266             | 2376          | ISZ WRDCNT           |
| 0267             | 5271          | JMP . +2             |
| 0270             | 5304          | JMP WRITE HLT        |
| 0271             | 2377          | ISZ STORAD           |
| 0272             | 2373          | ISZ CHNCNT           |
| 0273             | 5263          | JMP FLT              |
| 0274             | 5222          | JMP 222              |
| 0275             | 7000          | ATOD , NOP           |
| 0276             | 7300          | CLA CLL              |
| 0277             | 6532          | 6532                 |
| 0300             | 6531          | 6531                 |
| 0301             | 5300          | JMP . -1             |
| 0302             | 6534          | 6534                 |
| 0303             | 5675          | JMP I ATOD           |
| 0304             | 7000          | WRITE , NOP          |
| 0305             | 1371          | TAD ADRES            |
| 0306             | 3015          | DCA AUTOAD           |
| 0307             | 1367          | TAD NUMSMP           |
| 0310             | 7041          | CIA                  |
| 0311             | 3376          | DCA WRDCNT           |
| 0312             | 1415          | WOW , TAD I AUTOAD   |
| 0313             | 4320          | JMS TAPRIT           |
| 0314             | 2376          | ISZ WRDCNT           |
| 0315             | 5312          | JMP WOW              |
| 0316             | 4345          | JMS ENDREC           |
| 0317             | 7000          | NOP                  |
| 0320             | 7000          | TAPRIT , NOP         |

| REGISTER ADDRESS | OCTAL CONTENT | MNEMONIC INSTRUCTION |
|------------------|---------------|----------------------|
| 0321             | 6401          | 6401                 |
| 0322             | 5321          | JMP .-1              |
| 0323             | 6413          | 6413                 |
| 0324             | 7000          | NOP                  |
| 0325             | 7000          | NOP                  |
| 0326             | 7000          | NOP                  |
| 0327             | 6414          | 6414                 |
| 0330             | 7006          | RTL                  |
| 0331             | 7006          | RTL                  |
| 0332             | 7006          | RTL                  |
| 0333             | 6401          | 6401                 |
| 0334             | 5333          | JMP -.1              |
| 0335             | 6413          | 6413                 |
| 0336             | 7000          | NOP                  |
| 0337             | 7000          | NOP                  |
| 0340             | 7000          | NOP                  |
| 0341             | 6414          | 6414                 |
| 0342             | 7300          | CLA CLL              |
| 0343             | 5720          | JMP I TAPRIT         |
| 0344             | 7000          | NOP                  |
| 0345             | 7000          | ENDREC , NOP         |
| 0346             | 7300          | CLA CLL              |
| 0347             | 7604          | LAS                  |
| 0350             | 7510          | SPA                  |
| 0351             | 4360          | JMS ENDFIL           |
| 0352             | 6401          | 6401                 |
| 0353             | 5352          | JMP -.1              |
| 0354             | 6402          | 6402                 |
| 0355             | 7200          | CLA                  |
| 0356             | 5200          | JMP BEG              |
| 0357             | 7000          | NOP                  |
| 0360             | 7000          | ENDFIL , NOP         |
| 0361             | 6401          | 6401                 |
| 0362             | 5361          | JMP .-1              |
| 0363             | 6404          | 6404                 |
| 0364             | 7402          | HLT                  |
| 0365             | 0             | NUMAV , 0            |
| 0366             | 0             | NUMCHN , 0           |
| 0367             | 0             | NUMSMP , 0           |
| 0370             | 0             | TIME , 0             |
| 0371             | 1200          | ADRES , 1200         |
| 0372             | 0             | CNUMAV , 0           |

| REGISTER<br>ADDRESS | OCTAL<br>CONTENT | MNEMONIC<br>INSTRUCTION |
|---------------------|------------------|-------------------------|
| 0373                | 0                | CHNCNT , 0              |
| 0374                | 0001             | MUX , 0001              |
| 0375                | 0                | MUXAD , 0               |
| 0376                | 0                | WRDCNT , 0              |
| 0377                | 0                | STORAD , 0              |

## APPENDIX III.

## RESULTS OF SPECTRAL ANALYSES

RECORD 1131 WAVESLOPE - ROLL

Pre-filtering: average of 4 samples

Sampling period: 2.056 sec.

Nyquist frequency: 0.239 Hz

Number of bands averaged: 15

Bandwidth of spectrum: 0.007 Hz

Degrees of freedom: 30

Mean: Waveslope -0.014 Roll -0.016

Variance: Waveslope 2.13 Roll 8.93

| Frequency<br>(Hz) | Waveslope<br>Energy<br>(Deg. <sup>2</sup> -Sec.) | Roll<br>Energy<br>(Deg. <sup>2</sup> -Sec.) | Phase<br>Difference<br>(Degrees) | Coherence<br>Squared | Transfer<br>Function |
|-------------------|--|---|----------------------------------|----------------------|----------------------|
| .004              | 8.73   | 11.86                                       | 355.1                            | .974                 | 1.150                |
| .011              | 1.33   | 2.59  | 1.7                              | .593                 | 1.075                |
| .018              | 1.29   | 2.67  | 337.3                            | .449                 | .963                 |
| .025              | .85  | 1.45  | 342.8                            | .738                 | 1.121                |
| .032              | .90  | 1.64  | 341.1                            | .619                 | 1.065                |
| .039              | .69  | 1.63  | 6.3                              | .635                 | 1.228                |
| .046              | .81  | 1.66  | 357.6                            | .750                 | 1.235                |
| .053              | .75  | 1.47  | 10.4                             | .547                 | 1.032                |
| .061              | 1.11   | 2.22  | 9.0                              | .718                 | 1.201                |
| .068              | 2.38   | 5.39  | 2.6                              | .856                 | 1.393                |
| .075              | 6.49   | 12.80                                       | 1.6                              | .894                 | 1.328                |
| .082              | 26.10  | 66.78                                       | 9.3                              | .975                 | 1.579                |
| .089              | 22.42  | 57.56                                       | 10.9                             | .950                 | 1.562                |
| .096              | 29.45  | 103.97                                      | 17.8                             | .983                 | 1.863                |
| .103              | 24.15  | 109.22                                      | 19.9                             | .972                 | 2.096                |
| .111              | 21.67  | 138.09                                      | 28.2                             | .972                 | 2.489                |
| .118              | 24.26  | 207.58                                      | 44.1                             | .957                 | 2.861                |
| .125              | 23.18  | 241.99                                      | 66.1                             | .961                 | 3.166                |
| .132              | 19.43  | 166.97                                      | 85.7                             | .947                 | 2.583                |
| .139              | 8.95   | 38.15                                       | 107.4                            | .777                 | 1.820                |
| .146              | 8.79   | 27.24                                       | 121.5                            | .779                 | 1.553                |
| .153              | 12.38  | 22.54                                       | 129.7                            | .869                 | 1.258                |
| .160              | 9.57   | 9.64  | 125.0                            | .806                 | .901                 |
| .168              | 4.31   | 3.59  | 144.1                            | .520                 | .658                 |
| .175              | 5.50   | 2.70  | 142.7                            | .665                 | .571                 |
| .182              | 4.14   | 2.57  | 129.3                            | .261                 | .402                 |
| .189              | 4.22   | 1.86  | 168.7                            | .407                 | .423                 |
| .196              | 3.69   | 1.60  | 167.2                            | .244                 | .325                 |

## RECORD 1131 (continued)

| Frequency<br>(Hz) | Waveslope<br>Energy<br>(Deg. <sup>2</sup> -Sec.) | Roll<br>Energy<br>(Deg. <sup>2</sup> -Sec.) | Phase<br>Difference<br>(Degrees) | Coherence<br>Squared | Transfer<br>Function |
|-------------------|--|---|----------------------------------|----------------------|----------------------|
| .203              | 4.22   | 1.12  | 130.1                            | .014                 | .061                 |
| .210              | 2.85   | .69   | 171.8                            | .262                 | .252                 |
| .218              | 5.10   | .61   | 15.0                             | .060                 | .085                 |
| .225              | 2.53   | .61   | 317.2                            | .021                 | .070                 |
| .232              | 3.66   | .85   | 259.4                            | .008                 | .043                 |
| .239              | 2.76   | .53   | 158.4                            | .071                 | .117                 |



## RECORD 1133 WAVESLOPE - ROLL

Pre-filtering: none

Sampling period: 0.514 sec.

Nyquist frequency: 0.961 Hz.

Number of bands averaged: 5

Bandwidth of spectrum: 0.019 Hz.

Degrees of freedom: 10

Mean: Waveslope -0.05 Roll -0.06

Variance: Waveslope 0.99 Roll 2.14

| Frequency<br>(Hz) | Waveslope<br>Energy<br>(Deg. <sup>2</sup> -Sec.) | Roll<br>Energy<br>(Deg. <sup>2</sup> -Sec.) | Phase<br>Difference<br>(Degrees) | Coherence<br>Squared | Transfer<br>Function |
|-------------------|--|---|----------------------------------|----------------------|----------------------|
| .010              | 2.99   | 4.11  | 354.4                            | .965                 | 1.152                |
| .029              | .33  | .25   | 2.1                              | .719                 | .738                 |
| .048              | .15  | .10   | 36.8                             | .423                 | .547                 |
| .067              | .53  | 1.37  | 16.0                             | .935                 | 1.556                |
| .086              | 8.27   | 19.53                                       | 28.3                             | .979                 | 1.521                |
| .105              | 5.16   | 18.18                                       | 62.5                             | .938                 | 1.818                |
| .124              | 4.53   | 26.83                                       | 75.3                             | .699                 | 2.034                |
| .143              | 6.53   | 31.35                                       | 125.7                            | .675                 | 1.801                |
| .162              | 8.59   | 6.85  | 140.3                            | .770                 | .783                 |
| .181              | 5.27   | 1.93  | 123.1                            | .740                 | .521                 |
| .200              | 1.59   | .44   | 120.3                            | .286                 | .283                 |
| .219              | 2.12   | .32   | 145.3                            | .465                 | .265                 |
| .238              | .73  | .10   | 229.2                            | .112                 | .121                 |
| .257              | 1.63   | .09   | 209.4                            | .295                 | .129                 |

## RECORD 1133      ROLL - TANK PRESSURE

Pre-filtering: none

Sampling period: 0.514 sec.

Nyquist frequency: 0.961 Hz.

Number of bands averaged: 5

Bandwidth of spectrum: 0.019 Hz.

Degrees of freedom: 10

Mean:    Roll   -0.06            Pressure   41.3

Variance: Roll    2.14            Pressure    8.29

| Frequency<br>(Hz) | Roll<br>Energy<br>(Deg. <sup>2</sup> -Sec.) | Tank<br>Energy * | Phase<br>Difference<br>(Degrees) | Coherence<br>Squared | Transfer<br>Function |
|-------------------|---|------------------|----------------------------------|----------------------|----------------------|
| .010              | 4.11  | 6.26             | 6.4                              | .386                 | .766                 |
| .029              | .25   | 10.61            | 160.5                            | .007                 | .527                 |
| .048              | .10   | 3.93             | 330.8                            | .485                 | 4.270                |
| .067              | 1.37  | 8.95             | 319.6                            | .261                 | 1.305                |
| .086              | 19.53                                       | 23.87            | 280.3                            | .793                 | .984                 |
| .105              | 18.18                                       | 42.35            | 258.0                            | .962                 | 1.497                |
| .124              | 26.83                                       | 60.97            | 249.9                            | .817                 | 1.362                |
| .143              | 31.35                                       | 121.00           | 229.6                            | .879                 | 1.842                |
| .162              | 6.85  | 35.48            | 207.0                            | .859                 | 2.110                |
| .181              | 1.93  | 12.49            | 172.3                            | .766                 | 2.227                |
| .200              | .44   | 8.27             | 134.8                            | .080                 | 1.220                |
| .219              | .32   | 5.10             | 166.0                            | .179                 | 1.690                |
| .238              | .10   | 3.58             | 290.7                            | .353                 | 3.629                |
| .257              | .09   | 5.96             | 286.4                            | .151                 | 3.128                |

\* Uncalibrated

## RECORD 1134 WAVESLOPE - ROLL

Pre-filtering: none

Sampling period: 0.514 sec.

Nyquist frequency: 0.961 Hz.

Number of bands averaged: 5

Bandwidth of spectrum: 0.019 Hz.

Degrees of freedom: 10

Mean: Waveslope -0.05 Roll -0.08

Variance: Waveslope 1.80 Roll 3.88

| Frequency<br>(Hz) | Waveslope<br>Energy<br>(Deg. <sup>2</sup> -Sec.) | Roll<br>Energy<br>(Deg. <sup>2</sup> -Sec.) | Phase<br>Difference<br>(Degrees) | Coherence<br>Squared | Transfer<br>Function |
|-------------------|--|---|----------------------------------|----------------------|----------------------|
| .010              | .42  | .56   | 9.9                              | .577                 | .874                 |
| .029              | .15  | .20   | 22.6                             | .613                 | .888                 |
| .048              | .12  | .16   | 8.9                              | .125                 | .422                 |
| .067              | 3.52   | 6.94  | 11.7                             | .977                 | 1.387                |
| .086              | 23.25  | 57.33                                       | 20.2                             | .989                 | 1.562                |
| .105              | 17.50  | 61.58                                       | 47.5                             | .971                 | 1.848                |
| .124              | 18.50  | 50.26                                       | 84.4                             | .945                 | 1.603                |
| .143              | 8.67   | 17.53                                       | 111.1                            | .878                 | 1.332                |
| .162              | 8.70   | 6.84  | 129.8                            | .703                 | .744                 |
| .181              | 2.58   | .75   | 160.4                            | .744                 | .465                 |
| .200              | 2.55   | .27   | 143.9                            | .347                 | .192                 |
| .219              | .56  | .26   | 170.3                            | .423                 | .440                 |
| .238              | .78  | .12   | 124.3                            | .040                 | .077                 |
| .257              | 1.62   | .18   | 230.1                            | .136                 | .124                 |

## RECORD 1134      ROLL - TANK PRESSURE

Pre-filtering: none

Sampling period: 0.514 sec.

Nyquist frequency: 0.961 Hz.

Number of bands averaged: 5

Bandwidth of spectrum: 0.019 Hz.

Degrees of freedom: 10

Mean:    Roll    -0.08            Pressure 41.01

Variance: Roll    3.88            Pressure 12.38

| Frequency<br>(Hz) | Roll<br>Energy<br>(Deg. <sup>2</sup> -Sec.) | Tank<br>Energy* | Phase<br>Difference<br>(Degrees) | Coherence<br>Squared | Transfer<br>Function |
|-------------------|---|-----------------|----------------------------------|----------------------|----------------------|
| .010              | .56   | 6.88            | 87.6                             | .163                 | 1.418                |
| .029              | .20   | 4.69            | 29.1                             | .377                 | 2.977                |
| .048              | .16   | 7.04            | 334.9                            | .800                 | 5.858                |
| .067              | 6.94  | 7.30            | 33.9                             | .154                 | .403                 |
| .086              | 57.33                                       | 46.27           | 293.2                            | .932                 | .867                 |
| .105              | 61.58                                       | 124.51          | 275.5                            | .988                 | 1.414                |
| .124              | 50.26                                       | 159.84          | 248.2                            | .886                 | 1.679                |
| .143              | 17.53                                       | 59.01           | 243.2                            | .884                 | 1.725                |
| .162              | 6.84  | 35.74           | 211.5                            | .745                 | 1.973                |
| .181              | .75   | 12.33           | 198.9                            | .616                 | 3.182                |
| .200              | .27   | 5.42            | 202.3                            | .037                 | .859                 |
| .219              | .26   | 5.09            | 279.9                            | .338                 | 2.594                |
| .238              | .12   | 7.21            | 289.2                            | .105                 | 2.544                |
| .257              | .18   | 12.73           | 266.4                            | .362                 | 5.000                |

\* Uncalibrated

## RECORD 1136 WAVESLOPE - ROLL

Pre-filtering: average of 4 samples

Sampling period: 2.056 sec.

Nyquist frequency: 0.239 Hz.

Number of bands averaged: 15

Bandwidth of spectrum: 0.007 Hz.

Degrees of freedom: 30

Mean: Waveslope Roll -0.07

Variance: Waveslope 1.82 Roll 4.74

| Frequency<br>(Hz) | Waveslope<br>Energy<br>(Deg. <sup>2</sup> -Sec.) | Roll<br>Energy<br>(Deg. <sup>2</sup> -Sec.) | Phase<br>Difference<br>(Degrees) | Coherence<br>Squared | Transfer<br>Function |
|-------------------|--|---|----------------------------------|----------------------|----------------------|
| .004              | 10.49  | 11.30                                       | 9.7                              | .965                 | 1.020                |
| .011              | .50  | 1.39  | 334.1                            | .401                 | 1.057                |
| .018              | .63  | .83   | 330.0                            | .350                 | .680                 |
| .025              | .35  | .45   | 357.6                            | .553                 | .843                 |
| .032              | .42  | .38   | .4                               | .616                 | .748                 |
| .039              | .50  | .78   | 5.1                              | .593                 | .962                 |
| .046              | .46  | .71   | 6.7                              | .823                 | 1.119                |
| .053              | .47  | .71   | 358.2                            | .735                 | 1.051                |
| .061              | 1.12   | 2.20  | 9.1                              | .863                 | 1.303                |
| .068              | 4.96   | 10.76                                       | 13.3                             | .960                 | 1.444                |
| .075              | 23.20  | 49.61                                       | 14.1                             | .992                 | 1.457                |
| .082              | 37.82  | 86.87                                       | 16.0                             | .989                 | 1.507                |
| .089              | 17.46  | 50.55                                       | 20.4                             | .976                 | 1.684                |
| .096              | 28.67  | 95.33                                       | 25.3                             | .989                 | 1.813                |
| .103              | 18.94  | 70.42                                       | 31.0                             | .957                 | 1.886                |
| .111              | 15.87  | 71.19                                       | 41.2                             | .947                 | 2.061                |
| .118              | 11.37  | 39.27                                       | 44.9                             | .968                 | 1.829                |
| .125              | 13.73  | 55.50                                       | 56.2                             | .958                 | 1.967                |
| .132              | 7.08   | 27.36                                       | 70.2                             | .969                 | 1.935                |
| .139              | 7.12   | 26.20                                       | 81.8                             | .860                 | 1.778                |
| .146              | 8.99   | 29.37                                       | 94.7                             | .923                 | 1.737                |
| .153              | 6.36   | 12.89                                       | 105.4                            | .906                 | 1.356                |
| .160              | 4.38   | 7.45  | 112.1                            | .753                 | 1.132                |
| .168              | 4.18   | 3.24  | 127.5                            | .631                 | .699                 |
| .175              | 2.58   | 1.66  | 117.4                            | .661                 | .652                 |
| .182              | 4.39   | 2.45  | 139.6                            | .622                 | .589                 |
| .189              | 3.81   | 1.36  | 137.2                            | .494                 | .420                 |
| .196              | 3.86   | 1.28  | 144.3                            | .697                 | .482                 |
| .203              | 3.29   | .78   | 146.8                            | .331                 | .279                 |
| .210              | 3.22   | .52   | 165.4                            | .480                 | .278                 |
| .218              | 2.14   | .28   | 182.4                            | .048                 | .080                 |
| .225              | 1.89   | .44   | 181.3                            | .189                 | .209                 |
| .232              | 2.09   | .24   | 156.1                            | .091                 | .102                 |
| .239              | 2.08   | .24   | 184.3                            | .112                 | .114                 |

## RECORD 1136      ROLL - TANK PRESSURE

Pre-filtering: average of 4 samples

Sampling period: 2.056 sec.

Nyquist frequency: 0.239 Hz.

Number of bands averaged: 15

Bandwidth of spectrum: 0.007 Hz.

Degrees of freedom: 30

Mean:      Roll    -0.07              Pressure    165.11

Variance: Roll    4.88              Pressure    107.27

| Frequency<br>(Hz) | Roll<br>Energy<br>(Deg. <sup>2</sup> -Sec.) | Tank<br>Energy * | Phase<br>Difference<br>(Degrees) | Coherence<br>Squared | Transfer<br>Function |
|-------------------|---|------------------|----------------------------------|----------------------|----------------------|
| .004              | 11.25                                       | 122.78           | 325.3                            | .168                 | 1.354                |
| .011              | 1.36  | 15.10            | 348.2                            | .156                 | 1.316                |
| .018              | .81   | 8.82             | 336.1                            | .025                 | .522                 |
| .026              | .45   | 6.30             | 309.2                            | .069                 | .983                 |
| .033              | .36   | 8.57             | 330.7                            | .388                 | 3.039                |
| .040              | .76   | 6.26             | 67.4                             | .105                 | .930                 |
| .048              | .69   | 16.24            | 305.8                            | .073                 | 1.311                |
| .055              | .67   | 10.51            | 11.8                             | .038                 | .772                 |
| .062              | 2.18  | 11.89            | 3.9                              | .208                 | 1.065                |
| .070              | 10.81                                       | 13.03            | 301.6                            | .277                 | .578                 |
| .077              | 49.97                                       | 51.42            | 299.0                            | .843                 | .931                 |
| .084              | 87.03                                       | 67.37            | 290.7                            | .918                 | .843                 |
| .092              | 50.91                                       | 48.18            | 296.4                            | .705                 | .817                 |
| .099              | 95.77                                       | 121.64           | 285.9                            | .901                 | 1.070                |
| .106              | 70.60                                       | 118.60           | 283.4                            | .911                 | 1.237                |
| .114              | 71.52                                       | 132.04           | 283.7                            | .950                 | 1.324                |
| .121              | 39.25                                       | 79.63            | 265.7                            | .856                 | 1.318                |
| .128              | 55.56                                       | 135.24           | 253.1                            | .942                 | 1.514                |
| .136              | 27.58                                       | 81.63            | 242.9                            | .873                 | 1.607                |
| .143              | 26.04                                       | 73.85            | 240.8                            | .839                 | 1.543                |
| .150              | 29.51                                       | 125.88           | 222.2                            | .929                 | 1.991                |
| .158              | 12.93                                       | 59.45            | 203.8                            | .876                 | 2.007                |
| .165              | 7.51  | 30.54            | 200.8                            | .804                 | 1.808                |
| .172              | 3.17  | 15.15            | 199.6                            | .673                 | 1.793                |
| .180              | 1.67  | 12.61            | 163.1                            | .298                 | 1.500                |
| .187              | 2.42  | 18.01            | 179.1                            | .526                 | 1.979                |
| .194              | 1.34  | 11.66            | 174.9                            | .403                 | 1.873                |
| .202              | 1.28  | 8.29             | 181.7                            | .203                 | 1.378                |
| .209              | .76   | 10.85            | 107.1                            | .210                 | 1.731                |
| .216              | .52   | 9.26             | 151.0                            | .374                 | 2.581                |
| .224              | .28   | 4.96             | 147.1                            | .211                 | 1.933                |
| .231              | .42   | 7.81             | 169.3                            | .025                 | .682                 |
| .238              | .25   | 11.01            | 37.3                             | .058                 | 1.598                |
| .246              | .24   | 7.93             | 188.6                            | .109                 | 1.898                |

\* Uncalibrated

## RECORD 1171      WAVE HEIGHT

Pre-filtering: average of 3 samples

Sampling period: 0.927 sec.

Nyquist frequency: 0.530 Hz.

Number of bands averaged: 15

Bandwidth of spectrum: 0.016 Hz.

Degrees of freedom: 30

Mean:      Height 135.92

Variance: Height 448.86

---

| Frequency<br>(Hz) | Wave<br>Energy * |
|-------------------|------------------|
| .008              | 21.79            |
| .024              | 11.20            |
| .040              | 44.99            |
| .055              | 3435.57          |
| .071              | 947.62           |
| .087              | 8644.20          |
| .103              | 5583.42          |
| .119              | 2073.76          |
| .134              | 1201.75          |
| .150              | 1204.33          |
| .166              | 961.12           |
| .182              | 1303.90          |
| .198              | 917.93           |
| .214              | 934.57           |
| .229              | 541.76           |
| .245              | 189.00           |

---

\* Uncalibrated

## RECORD 1172 WAVESLOPE - ROLL

Pre-filtering: average of 3 samples

Sampling period: 0.927 sec.

Nyquist frequency: 0.530 Hz.

Number of bands averaged: 15

Bandwidth of spectrum: 0.016 Hz.

Degrees of freedom: 30

Mean: Waveslope -0.04 Roll -0.06

Variance: Waveslope 0.66 Roll 2.67

| Frequency<br>(Hz) | Waveslope<br>Energy<br>(Deg. <sup>2</sup> -Sec.) | Roll<br>Energy<br>(Deg. <sup>2</sup> -Sec.) | Difference<br>(Degrees) | Coherence<br>Squared | Transfer<br>Function |
|-------------------|--|---|-------------------------|----------------------|----------------------|
| .008              | 6.13   | 5.25  | 315.0                   | .877                 | .866                 |
| .024              | .08  | .23   | 6.9                     | .482                 | 1.198                |
| .040              | .09  | .20   | 359.1                   | .649                 | 1.218                |
| .055              | .13  | .21   | 15.3                    | .643                 | 1.038                |
| .071              | .18  | .41   | 5.2                     | .633                 | 1.208                |
| .087              | 3.99   | 12.46                                       | 13.1                    | .951                 | 1.722                |
| .103              | 7.08   | 30.54                                       | 29.0                    | .933                 | 2.006                |
| .119              | 7.51   | 74.14                                       | 61.2                    | .895                 | 2.972                |
| .134              | 4.50   | 36.85                                       | 99.4                    | .901                 | 2.680                |
| .150              | 1.93   | 4.61  | 158.3                   | .767                 | 1.353                |
| .166              | 3.26   | 2.96  | 170.9                   | .752                 | .827                 |
| .182              | 2.01   | .50   | 160.5                   | .628                 | .395                 |
| .198              | .72  | .21   | 181.7                   | .392                 | .336                 |
| .214              | .84  | .17   | 144.2                   | .147                 | .174                 |
| .229              | .40  | .16   | 77.6                    | .077                 | .174                 |
| .245              | .36  | .20   | 323.6                   | .019                 | .104                 |



## RECORD 1173 WAVESLOPE - ROLL

Pre-filtering: average of 3 samples

Sampling period: 0.927 sec.

Nyquist frequency: 0.530 Hz.

Number of bands averaged: 15

Bandwidth of spectrum: 0.016 Hz.

Degrees of freedom: 30

Mean: Waveslope -0.03 Roll -0.04

Variance: Waveslope 0.91 Roll 1.00

| Frequency<br>(Hz) | Waveslope<br>Energy<br>(Deg. <sup>2</sup> -Sec.) | Roll<br>Energy<br>(Deg. <sup>2</sup> -Sec.) | Difference<br>(Degrees) | Coherence<br>Squared | Transfer<br>Function |
|-------------------|--|---|-------------------------|----------------------|----------------------|
| .008              | .39  | 1.05  | 358.6                   | .557                 | 1.222                |
| .024              | .18  | .42   | 25.3                    | .667                 | 1.249                |
| .040              | .06  | .23   | 15.9                    | .230                 | .897                 |
| .055              | .15  | .39   | 12.3                    | .192                 | .698                 |
| .071              | .14  | .54   | 15.2                    | .479                 | 1.371                |
| .087              | 1.20   | 5.50  | 17.1                    | .920                 | 2.051                |
| .103              | 1.38   | 8.74  | 25.9                    | .891                 | 2.375                |
| .119              | 1.54   | 7.52  | 54.4                    | .926                 | 2.125                |
| .134              | 2.60   | 7.32  | 69.8                    | .906                 | 1.597                |
| .150              | 3.97   | 7.64  | 84.7                    | .906                 | 1.320                |
| .166              | 4.46   | 7.73  | 105.0                   | .834                 | 1.203                |
| .182              | 10.91  | 6.89  | 140.4                   | .764                 | .694                 |
| .198              | 13.26  | 6.09  | 140.9                   | .793                 | .603                 |
| .214              | 6.23   | 1.62  | 174.1                   | .532                 | .372                 |
| .229              | 2.86   | .35   | 184.3                   | .520                 | .253                 |
| .245              | 1.69   | .51   | 159.1                   | .291                 | .296                 |

## RECORD 1173      ROLL - TANK PRESSURE

Pre-filtering: average of 3 samples

Sampling period: 0.927 sec.

Nyquist frequency: 0.530 Hz.

Number of bands averaged: 15

Bandwidth of spectrum: 0.016 Hz.

Degrees of freedom: 30

Mean:      Roll   -0.04              Pressure   12.24

Variance: Roll    1.00              Pressure    0.25

| Frequency<br>(Hz) | Roll<br>Energy<br>(Deg. <sup>2</sup> -Sec.) | Tank<br>Energy * | Phase<br>Difference<br>(Degrees) | Coherence<br>Squared | Transfer<br>Function |
|-------------------|---|------------------|----------------------------------|----------------------|----------------------|
| .008              | 1.05  | 49.83            | 201.6                            | .184                 | 2.955                |
| .024              | .42   | 2.96             | 264.3                            | .020                 | .375                 |
| .040              | .23   | 5.15             | 312.6                            | .040                 | .946                 |
| .055              | .39   | 2.76             | 244.7                            | .041                 | .539                 |
| .071              | .54   | 2.58             | 32.7                             | .043                 | .453                 |
| .087              | 5.50  | 1.96             | 30.5                             | .062                 | .149                 |
| .103              | 8.74  | 3.60             | 307.2                            | .312                 | .358                 |
| .119              | 7.52  | 4.64             | 278.9                            | .628                 | .622                 |
| .134              | 7.32  | 4.41             | 273.4                            | .389                 | .484                 |
| .150              | 7.64  | 5.33             | 248.8                            | .740                 | .719                 |
| .166              | 7.73  | 8.98             | 213.0                            | .609                 | .841                 |
| .182              | 6.89  | 9.60             | 199.1                            | .623                 | .932                 |
| .198              | 6.09  | 9.97             | 181.5                            | .629                 | 1.015                |
| .214              | 1.62  | 3.76             | 240.5                            | .366                 | .922                 |
| .229              | .35   | 2.21             | 3.9                              | .122                 | .878                 |
| .245              | .51   | 3.77             | 205.5                            | .227                 | 1.295                |