

AN ABSTRACT OF THE THESIS OF

DENNIS RICHARD DELZER for the M.S. in  
(Name) (Degree)

ELECTRICAL AND ELECTRONICS ENGINEERING  
(Major)

Date thesis is presented August 29, 1966

Title REACTIVELY SPUTTERED FILMS OF SILICON NITRIDE FOR  
DIFFUSION MASKING

Abstract approved  \_\_\_\_\_  
(Major professor)

The experimental procedure for reactively sputtering films of silicon nitride together with the methods for measuring the film thickness have been investigated. Some of the properties of these nitride films were studied. These properties included: infrared spectrum, etching properties, and index of refraction. The adherence of the films was also investigated.

Research was conducted on the sputtering properties of silicon nitride. Some of the secondary parameters which affect the sputtering rate were studied. These parameters included: cathode-to-substrate distance, applied voltage, gas pressure, and time. The uniformity of the sputtered films was also investigated. The results of these experiments were similar to the results of many published reports on sputtering.

The last area of research covered by this thesis

was the masking ability of the silicon nitride films. It was found that these reactively sputtered silicon nitride films effectively masked against the diffusion of boron and phosphorus in silicon. The minimum masking thickness was also studied. The masking ability of these nitride films against zinc diffusion in gallium arsenide was not conclusively proven. It appeared that the nitride films were masking against zinc diffusion, but the results were erratic. It was concluded that the diffusion technique was producing these poor results. More work on masking in GaAs was suggested using different diffusant sources.

REACTIVELY SPUTTERED FILMS OF SILICON NITRIDE  
FOR DIFFUSION MASKING

by

DENNIS RICHARD DELZER

A THESIS

submitted to

OREGON STATE UNIVERSITY

in partial fulfillment  
of the requirements for the  
degree of

MASTER OF SCIENCE

June 1967

APPROVED:

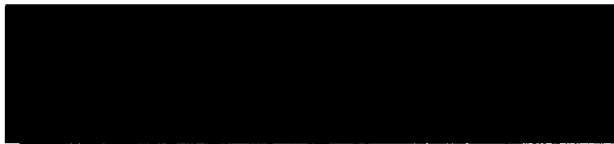

---

Associate Professor of Electrical and  
Electronics Engineering  
In Charge of Major

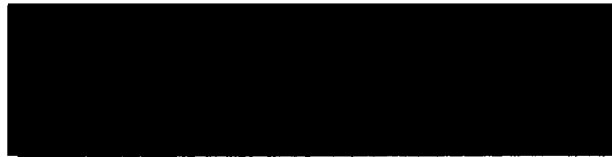

---

Head of Department of Electrical and  
Electronics Engineering

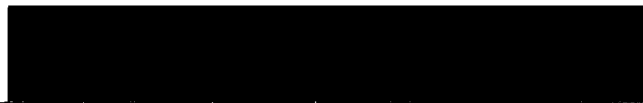

---

Dean of Graduate School

Date thesis is presented August 29, 1966

Typed by Erma McClanathan

## ACKNOWLEDGMENTS

The author wishes to express his deepest appreciation to Professor James C. Looney for his many suggestions and valuable guidance throughout the course of this thesis.

Also, gratitude is expressed to Professor John C. Decius for his help in obtaining the infrared spectroscopy data used in this thesis.

## TABLE OF CONTENTS

I.	Introduction.....	1
II.	Substrate Cleaning Procedure.....	7
	A. Glass Substrates.....	7
	B. Silicon Substrates.....	8
III.	Deposition Technique.....	10
	A. Experimental Apparatus.....	10
	B. Experimental Procedure.....	16
IV.	Silicon Nitride Film Thickness Measurement..	18
	A. Two-Beam Interference Method with Metallized Sample.....	18
	B. Two-Beam Interference Method with Non-Metallized Sample.....	20
V.	Some Silicon Nitride Properties.....	22
	A. Infrared Spectroscopy.....	22
	B. Etching Tests.....	27
	C. Index of Refraction Measurement.....	29
	D. Miscellaneous.....	30
VI.	Sputtering Properties of Silicon Nitride....	32
	A. Effect of Cathode-Substrate Distance on Film Thickness.....	32
	B. Effect of Applied Voltage on Film Thickness.....	35
	C. Effect of Gas Pressure on Film Thickness.....	38
	D. Effect of Sputtering Time on Film Thickness.....	40
	E. Uniformity of the Sputtered Films....	45
VII.	Masking Against Boron Diffusion in Silicon..	49
	A. Silicon Wafer Preparation.....	49
	B. The Diffusion Process.....	50
	C. Determining the Masking Ability of the Silicon Nitride Films.....	51

VIII.	Masking Against Phosphorus Diffusion in Silicon.....	54
	A. Silicon Wafer Preparation.....	54
	B. The Diffusion Process.....	54
	C. Determining the Masking Ability of the Silicon Nitride Films.....	55
IX.	Masking Against Zinc Diffusion in Gallium Arsenide.....	58
	A. Gallium Arsenide Wafer Preparation.....	58
	B. The Diffusion Process.....	59
	C. Determining the Masking Ability of the Silicon Nitride Films.....	60
X.	Summary and Conclusions.....	64
XI.	Suggestions for Improving Future Investigations.....	66
	Bibliography.....	69
	Appendix	
	Table V.....	72
	Table VI.....	73
	Table VII.....	74
	Table VIII.....	75
	Table IX.....	76
	Table X.....	77
	Table XI.....	78
	Table XII.....	79
	Sample Calculation.....	80

## LIST OF FIGURES

1.	Block Diagram of Silicon Nitride Sputtering System.....	11
2.	Cross-Section of Pyrex and Aluminum Sputtering Module.....	13
3.	Infrared Absorption Spectra for Similar Silicon Substrates.....	23
4.	Infrared Absorption Spectra for Identical Silicon Substrates.....	25
5.	Maximum Film Thickness Versus Cathode-to-Substrate Distance Using an Aluminum Substrate Holder.....	33
6.	Maximum Film Thickness Versus Cathode-to-Substrate Distance Using a Glass Substrate Holder.....	36
7.	Maximum Film Thickness Versus Applied Voltage..	37
8.	Maximum Film Thickness Versus Gas Pressure.....	39
9.	Maximum Film Thickness Versus Sputtering Time Using Glass Substrates.....	41
10.	Maximum Film Thickness Versus Sputtering Time Using 50% Argon-50% Nitrogen.....	43
11.	Maximum Film Thickness Versus Sputtering Time Using Silicon Substrates.....	44
12.	Film Thickness Versus Distance from the Center of the Cathode.....	47



## LIST OF TABLES

I.	Index of Refraction Measurements of Silicon Nitride Films.....	30
II.	Boron Diffusion Masking in Silicon by Silicon Nitride.....	53
III.	Phosphorus Diffusion Masking in Silicon by Silicon Nitride.....	57
IV.	Zinc Diffusion Masking in Gallium Arsenide by Silicon Nitride.....	61
V.	Maximum Film Thickness Versus Cathode-to-Substrate Distance Using an Aluminum Substrate Holder.....	72
VI.	Maximum Film Thickness Versus Cathode-to-Substrate Distance Using a Glass Substrate Holder.....	73
VII.	Maximum Film Thickness Versus Applied Voltage	74
VIII.	Maximum Film Thickness Versus Gas Pressure...	75
IX.	Maximum Film Thickness Versus Sputtering Time Using Glass Substrates.....	76
X.	Maximum Film Thickness Versus Sputtering Time Using 50% Argon-50% Nitrogen.....	77
XI.	Maximum Film Thickness Versus Sputtering Time Using Silicon Substrates.....	78
XII.	Film Thickness Versus Distance from Center of the Cathode.....	79

# REACTIVELY SPUTTERED FILMS OF SILICON NITRIDE FOR DIFFUSION MASKING

## I. INTRODUCTION

Selective diffusion by means of masking is the heart of solid state device fabrication and integrated circuit technology. Films that act as diffusion masks are ones through which impurities diffuse very slowly compared to the diffusion rate of the impurity in the substrate. A great amount of research has been done on various kinds of films that act as diffusion masks.

The most commonly used films for diffusion masking are silicon dioxide and silicon monoxide. Silicon dioxide is more widely used because it is easily adapted to silicon device technology, and it is usually more impervious to most diffusion materials.

Within the past two years, a new film has been given a preliminary investigation by the Sperry Rand Corporation (20, 21, 27, and 28) for use as a diffusion mask, dielectric, and passivation layer. This new film is silicon nitride. The exact method that was used to deposit these films of silicon nitride has not been disclosed.

At the time this thesis was being written, two articles were published by researchers at IBM (10 and 17) on films of silicon nitride. One of these articles (10) discussed pyrolytically deposited films while the other

article (17) discussed reactively sputtered films.

Little work had been done with films of silicon nitride until 1960, the main reasons being that silicon nitride does not adapt as readily to silicon device technology as does silicon dioxide, and no one seems to have found a use for it until just recently. There have been a few reports during the past seven years on methods of depositing films of silicon nitride. Until the reports of last year, all of these films of silicon nitride were used for dielectric purposes in thin-film capacitors.

The four methods of deposition that have been used in the past are: pyrolytically deposited films (1, p. 98 and 10, p. 561); vacuum evaporated films (11, p. 1459); reactively sputtered films (8, p. 38 and 17, p. 693); and some form of chemical technique (20, 21, 27, and 28). Reactive sputtering was the technique used in this thesis to deposit films of silicon nitride because the sputtering equipment is simple, inexpensive, and versatile; and the sputtered films adhere well to most substrates.

Cathode sputtering is a very old process which was first reported by Grove in 1852 and by Plucker in 1858. A great many papers, articles, and books have been published on this subject. The three classic references seem to be Holland (15), Wehner (29), and Kay (19). Although cathode sputtering is a very old process and

much research has been done on it, a single, complete theory has not been found which will accurately describe this complex phenomenon. It should be stated that this thesis is not involved with trying to explain the mechanisms of sputtering, but merely uses sputtering as a method of obtaining films of silicon nitride.

A simple definition of cathode sputtering is the ion bombardment of a cathode in a glow discharge. Sputtering is performed using equipment similar to that for evaporation. A low pressure (0.01 to 0.1 torr) is maintained by bleeding a gas, usually argon, into a bell jar while pumping on it with a vacuum pump. A glow discharge is initiated by applying a high voltage between cathode and anode. The substrate may rest on the anode or be placed in the glow region. Argon ions ( $A^+$ ) produced by the discharge are accelerated toward the cathode and gain sufficient energy to knock atoms (or molecules) out of the cathode. Atoms knocked loose from the cathode by the impinging ions have sufficient velocity so that when they hit the substrate they usually adhere well. Sputtering is generally slower than evaporation, depositing a micron-thick film in minutes to hours, compared to seconds to minutes for evaporation. Usually voltages as high as 5000 volts are applied between the cathode and anode.

Reactive sputtering is a relatively new form of

cathode sputtering which has developed most rapidly over the past ten years due to the advances in solid state technology and fabrication. Reactive sputtering is when a reactive gas such as oxygen or nitrogen is used alone or together with argon to bombard the cathode. The oxygen or nitrogen atoms react with cathode material to form oxides or nitrides. When a metal cathode is sputtered in oxygen (15, p. 457), the following mechanisms may operate simultaneously: (i) production of an oxide layer on the cathode surface which is removed under positive ion bombardment; (ii) oxygen absorption by the sputtered atoms in transit; and (iii) oxygen absorption by the sputtered film during its formation. When nitrogen is used, (ii) and (iii) appear to be the more dominant mechanisms (15, p. 459).

The greatest portion of the work done with reactive sputtering has been done with oxides. A good example of this is the silicon dioxide work done by Sinclair and Peters (26).

After a literature search, only two published examples could be found for reactively sputtered silicon nitride (8, p. 38 and 17, p. 693). The first report (8, p. 4) stated that, "Exploratory experiments in which silicon was sputtered in an argon-nitrogen mixture showed that  $\text{Si}_3\text{N}_4$  films (contaminated with  $\text{SiO}$ ) of good

dielectric quality were formed." Confirmation that the films were silicon nitride ( $\text{Si}_3\text{N}_4$ ) was obtained through infrared spectra of the films. The argon-nitrogen mixture was varied from 5% to 50% nitrogen. The typical gas pressure was 0.01 to 0.02 torr. The discharge conditions were 2.5 to 3.5 kv at 2 to 5 ma. The second report by IBM (17, p. 693) was published at the time this report was being written. Both r.f. and d.c. sputtered nitride films were deposited. Only nitrogen was used for a gas. Various physical properties of these sputtered films were investigated. Some of the properties included: amorphism, infrared absorption spectrum, index of refraction, masking properties, and several other properties.

The purpose of this study was to investigate the technique of reactive sputtering of silicon nitride films and to study the diffusion masking properties of these films. The project was divided into primarily three parts. The first part deals with some of the properties of the silicon nitride films. These properties include infrared spectrum, etching tests, and index of refraction. The second part of this research was concerned with how the film thickness behaves as various sputtering parameters are varied. Some of these parameters are cathode-to-substrate distance, applied voltage, gas pressure, and time. The uniformity of the sputtered films was also

investigated. The third part of this project involves using the sputtered films as diffusion masks. The masking properties of these films against boron and phosphorus diffusion in silicon substrates were studied. Also, the masking properties against zinc diffusion in gallium arsenide substrates were investigated. These results are compared with previously published reports on diffusion masking.

## II. SUBSTRATE CLEANING PROCEDURE

Substrate cleaning is essential in vacuum coating work. Good adherence to the substrate material can be achieved if the substrate surfaces are clean and free of moisture and oil contamination. There are numerous procedures for substrate cleaning. Solvent, detergent, and ultrasonic cleaning are commonly used.

Two kinds of substrates were used for most of the experiments in this project. For most of the film thickness measurements, 1" x 1.5" glass microscope slides were used. Transistor grade 3/4 inch diameter silicon wafers were used for most of the diffusion masking tests.

### A. Glass Substrates

The following procedures were used for the glass substrate cleaning:

1. The selected substrates were immersed in a beaker containing detergent and water.
2. The beaker was then placed on a hot-plate and boiled for ten minutes.
3. After this, the substrates were taken out and rinsed under the water faucet for two minutes.
4. The detergent bath of the 40-kc ultrasonic cleaner was filled with sufficient detergent and water; the substrates were then immersed in the detergent bath with ultrasonic agitation for ten minutes.



5. The substrates were then rinsed in de-ionized water for five minutes.
6. The substrates were boiled for five minutes in methanol and then boiled in concentrated nitric acid for five minutes.
7. Finally, the substrates were rinsed in de-ionized water for ten minutes.
8. The substrates were then dried with bibulous paper and stored under a dust-free cover until used.

#### B. Silicon Substrates

Since the silicon wafers used in this research had already been lapped and etched quite smoothly, only a cleaning procedure was required to remove any oils and contamination. The following procedures were used to prepare the wafers for sputtering:

1. The wafers were first immersed in trichloroethylene and allowed to soak for ten minutes to remove any oils and grease.
2. The wafers were then rinsed for five minutes in acetone and then rinsed for five minutes in methanol.
3. The wafers were etched in 48% hydrofluoric acid for ten minutes to remove any oxide layers.
4. Next, the wafers were rinsed under the water faucet for two minutes.
5. Then, the wafers were given a five minute ultrasonic agitation in detergent.

6. Finally, the wafers were rinsed in de-ionized water for ten minutes.
7. The wafers were then dried with bibulous paper and stored under a dust-free cover until used.

It would have been desirable to have dried the substrates in a filtered air chamber to insure a dust-free surface, but such a device was not available. Although these cleaning procedures should be followed quite closely, the condition of the substrate in sputtering is not as critical as it is for evaporation techniques. Using the above cleaning procedures, the sputtered silicon nitride films were found to adhere very well.

### III. DEPOSITION TECHNIQUE

#### A. Experimental Apparatus

A block diagram of the system used in this thesis for sputtering films of silicon nitride is shown in Figure 1. A Mikros model VE-10 manual valving vacuum system with a specially constructed pyrex and aluminum sputtering module was used for making the films. The system was evacuated by an oil diffusion pump backed by a rotary mechanical pump, and the sputtering module could be evacuated to a pressure of about  $5 \times 10^{-4}$  torr in less than 15 minutes.

A power supply variable from 0 to 2500 volts with a current capacity of 500 ma is shown in the lower part of the diagram. Since unfiltered d.c. is satisfactory for sputtering, this power supply consists of a variable transformer, high voltage transformer, and a solid state full-wave bridge rectifier. A high reactance transformer placed in series with the input of the high voltage transformer was used for current limitation purposes to protect the rectifier diodes. The high reactance transformer reduced the tendency of an arc discharge, and it protected the power supply components in case that an arc discharge did occur.

The pressure in the sputtering system was measured

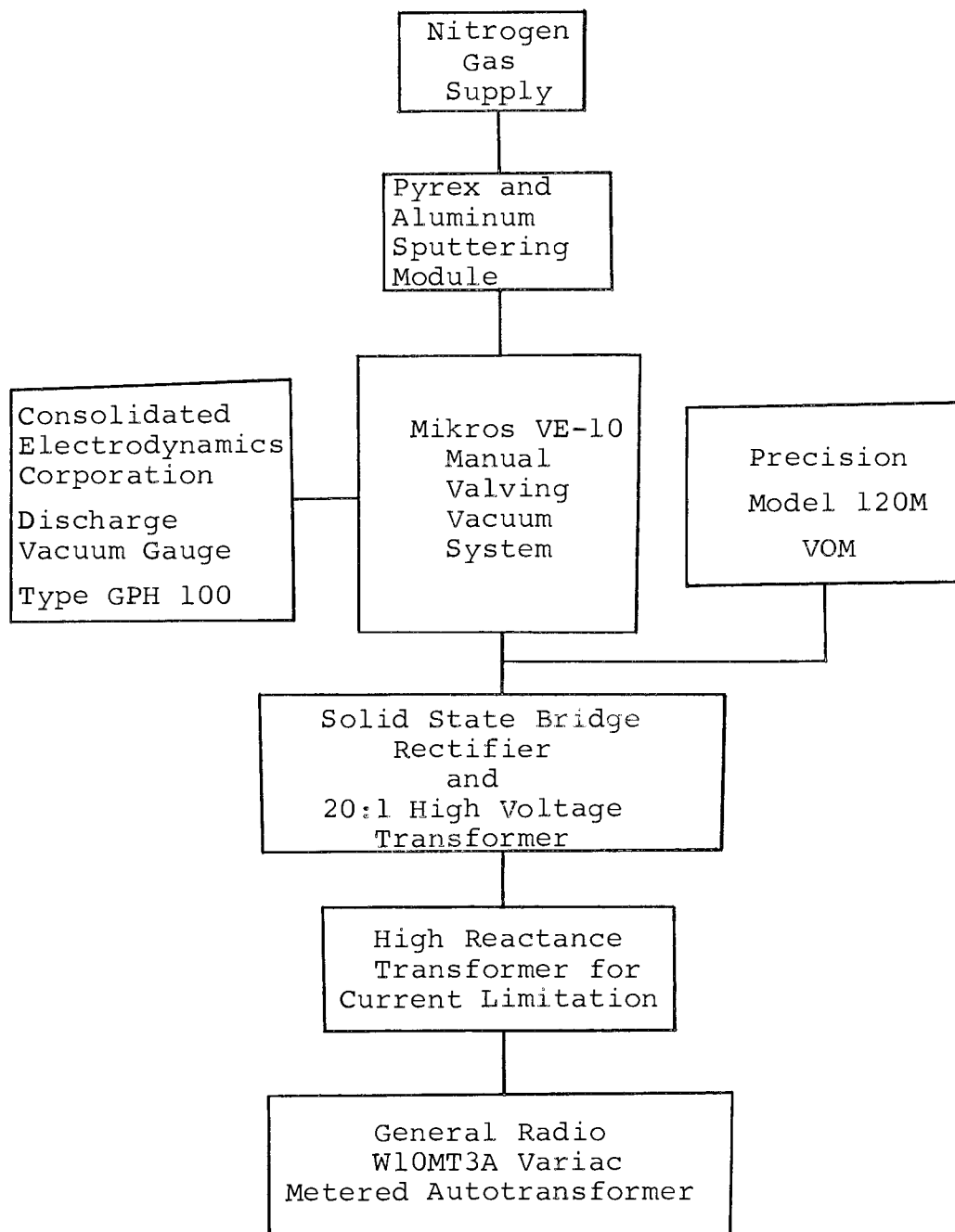

Figure 1. Block diagram of silicon nitride sputtering system.

by means of a discharge type vacuum gauge. The voltage was measured with a standard VOM using the high voltage scale.

The pyrex and aluminum sputtering module is shown in Figure 2. This sputtering module is similar to many modules which have been used in previous sputtering research (3, p. 293 and 15, p. 437). This module possesses the following properties: (1) versatility; (2) simple, rapid operation including setup time, change over from material to material, and cleaning; (3) independent control of as many of the deposition parameters as possible; (4) reliable operation; and (5) low initial investment.

The sputtering module consists mainly of an extra thick pyrex pipe section (6" high and 2" I.D.) which houses the cathode, anode, and substrate holder. The module was set over the pumping port on the base plate of the vacuum system. The cathode and anode sections with "O" ring seals were machined out of aluminum.

Two types of substrate holders were tried. One holder consisted of a 3/4 inch aluminum shaft that had been threaded so it could be screwed into the anode section; and thus, the cathode-to-substrate distance could be varied. It should be noted that in this case the substrate was actually resting on the anode. Hence, the

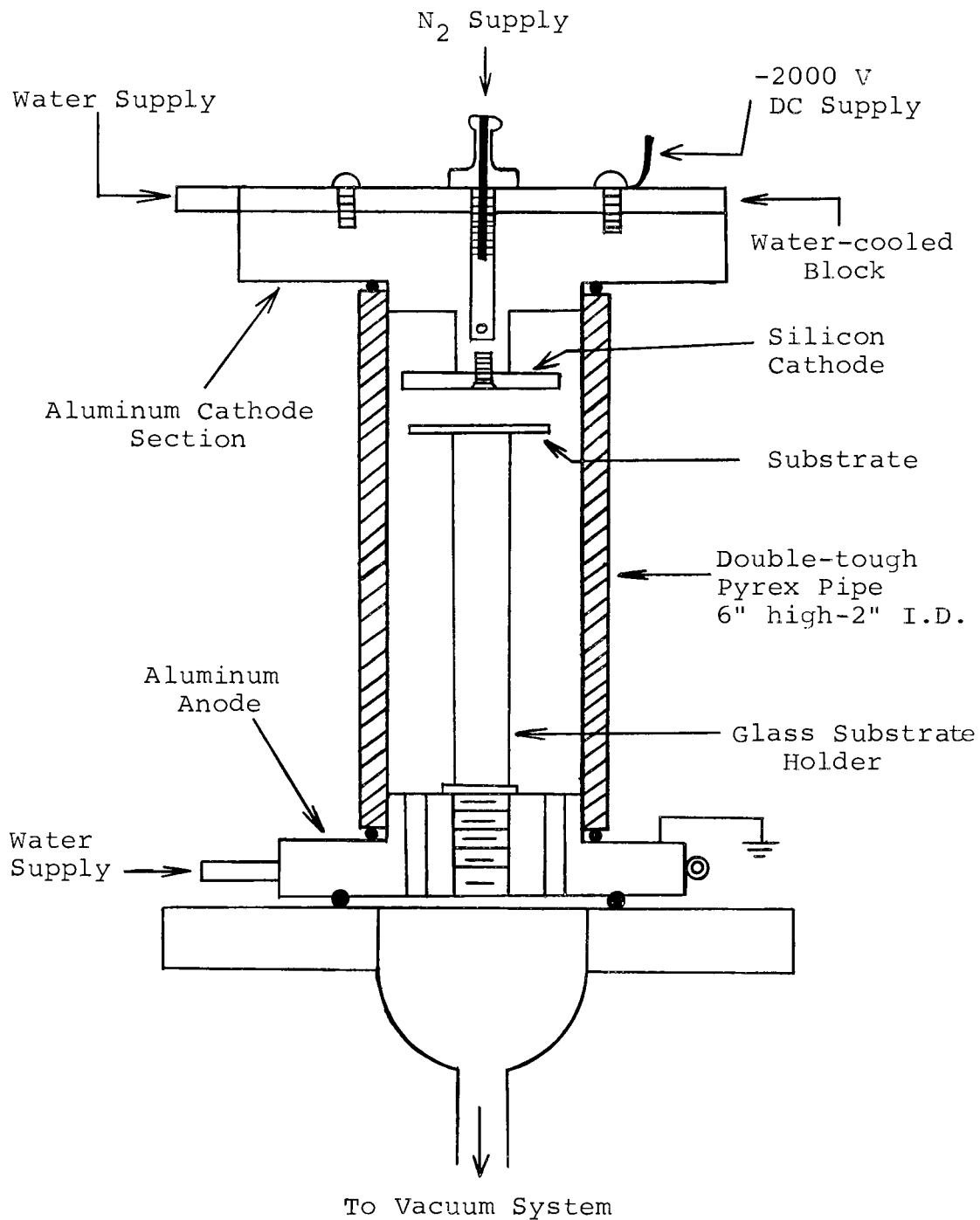

Figure 2. Cross-section of pyrex and aluminum sputtering module.

cathode-to-substrate distance was the same as the cathode-to-anode distance. The other holder consisted of a 3/4 inch pyrex pipe. A number of pipes were cut to graduated lengths to allow adjustment of the cathode-to-substrate distance. In this case, the cathode-to-anode distance remained fixed.

Since considerable amounts of power are used in sputtering and since most of this power is dissipated as heat, provision must be made to remove this heat to prevent uncontrolled temperature rises and cause deterioration of the vacuum seals, excessive outgassing, and pressure changes. As can be seen from the diagram, both the cathode and anode were water cooled. Although not directly shown on the diagram, water first circulates around the anode, then goes to the cathode, and finally flows to a drain. A six-foot length of flexible tygon tubing was attached to the outlet to provide necessary electrical isolation between the water drain and the cathode which was operated at a high negative potential with respect to ground. Another six-foot length of tygon tubing was connected between the anode and cathode to provide electrical isolation.

Nitrogen and argon were supplied from commercial gas cylinders equipped with regulators. The purity of these gases was 99.997%. The gases were brought to the

sputtering module through separate gas lines and leak valves. It should be noted that nitrogen was used exclusively for all sputtering experiments in this report except for one special case. Little work was done with gas mixing because a separate mixing chamber was required, and special gas measuring apparatus was needed to determine the exact proportions of the gas mixture. In the one case where argon was used with nitrogen, they were mixed in the sputtering module in approximately 50-50 proportions. The pressures used during the sputtering operation were achieved by balancing an adjustable leak valve against the speed of the diffusion pump. By feeding the desired gas through a leak valve at the top of the sputtering apparatus and using a diffusion pump at the bottom, a high volume flow of gas could be maintained in the chamber. This provided for fairly stable pressures in the module. Because a diffusion pump has an approximately constant mass throughput at the pressures used, a small change in the rate at which gas was admitted by the leak valve caused wide variation in pressures.

The silicon cathodes were made from 1.5 inch diameter transistor grade silicon wafers. A countersunk hole was drilled in the center of these wafers with a Raytheon ultrasonic grinder. These silicon wafers were then attached to the aluminum conductor by means of an



aluminum screw passed through the hole in the centers of the wafers. This is the same method that was used by Sinclair and Peters for silicon dioxide sputtering (26, p. 21).

### B. Experimental Procedure

In a typical silicon nitride sputtering experiment, a cleaned substrate was first placed in the sputtering module on top of the appropriate substrate holder. Another small piece of glass that had been cleaned was placed on the substrate as a mask to give a step for film thickness measurements. The substrate was now half covered by the mask, and the intersection of the covered and uncovered portions was placed under the center of the cathode to obtain the maximum sputtering rate. The sputtering module was then closed, and the chamber was pumped down to a pressure of  $5 \times 10^{-4}$  torr in less than 15 minutes. The water was turned on to cool the cathode and anode. Nitrogen, at a line pressure of 15 psi, was slowly admitted into the module by means of the leak valve until the pressure was  $5 \times 10^{-2}$  torr. The system was then allowed to stabilize and outgas for ten minutes. The power supply was turned on, and the voltage was gradually increased to 2000 volts. The current under these conditions was 30 ma. These values produced the

abnormal glow condition with its abundant supply of ions and uniform covering of the cathode that is useful for glow discharge sputtering. The cathode dark space extended 1.5 cm below the cathode and was a dark purple in color. The rest of the module was enveloped in a bright pink glow of varying intensity depending upon the position in the tube. The substrate was not heated by any other source than the glow discharge itself. This had been done previously for silicon dioxide with good results by Sinclair and Peters (26, p. 22). Although no temperature measurements were taken for this project, it has been reported that, due to the sputtering mechanism, the substrate is usually heated to over 50° C. As soon as the required sputtering time was reached, the voltage was gradually decreased and shut off. The nitrogen leak valve was turned off and the system was allowed to cool for ten minutes. The system was then opened, and the substrate removed.

#### IV. SILICON NITRIDE FILM THICKNESS MEASUREMENT

There are several methods by which the thickness of the deposited films of silicon nitride could be measured. Some methods commonly used for film thickness measurements are: (i) optical interference methods (namely, wedge method, two-beam interference method with metallized or non-metallized sample, and multiple-beam interference method); (ii) the color reference method (comparing the color of the unknown with the colors of a set of standard films of different thickness); and (iii) weight change method (weigh the sample before and after the deposition of the film in a microbalance).

In this project, the thickness of the silicon nitride films was measured mainly by the two-beam interference method with metallized samples. When measuring the index of refraction of the silicon nitride films, the two-beam interference method with non-metallized samples was also used.

##### A. Two-Beam Interference Method With Metallized Sample

The sample with a uniform wedge-shaped silicon nitride film step, fabricated by the previously mentioned sputtering technique, was metallized by depositing a thin film of aluminum on the surface with a vacuum evaporator.

The metallized sample was then examined with a Unitron metallurgical microscope equipped with a Watson interference objective. A fringe system was obtained with monochromatic light (sodium light,  $\lambda = 5890 \text{ \AA}$ , was used for part of this project and mercury light with an appropriate green filter,  $\lambda = 5460 \text{ \AA}$ , was used the rest of the time). This fringe system was examined under the microscope. The displacement of the fringes on going from the aluminum base to the silicon nitride film corresponds to a step up. The film thickness was calculated by (6, p. 1206)

$$d = p \frac{\lambda}{2}$$

where  $d$  = the thickness of the silicon nitride film  
 $\lambda$  = the wavelength of the monochromatic light  
 $p$  = the fringe displacement.

An accuracy of measurement within  $\pm 0.1$  fringe can be obtained by this method.

When silicon substrates were used, a mask was not used during the sputtering process to produce a step. Instead, the step was obtained by first applying a solution of Apiezon W wax in trichloroethylene to one half of the silicon sample surface possessing the nitride film. The trichloroethylene rapidly evaporated, leaving a hard wax surface film. The sample was immersed for 60 seconds in 48% hydrofluoric acid to dissolve the

unprotected half of the nitride film. The sample was then thoroughly rinsed, and the wax was removed with trichloroethylene. Undercutting of the wax layer by the hydrofluoric acid produced a relatively uniform, wedge-shaped nitride film step. A portion of the sample possessing a nitride film was then metallized with aluminum, and the film thickness was measured by the same method as the glass substrate that has been described previously. A section of the metallized silicon sample is shown by the following sketch.

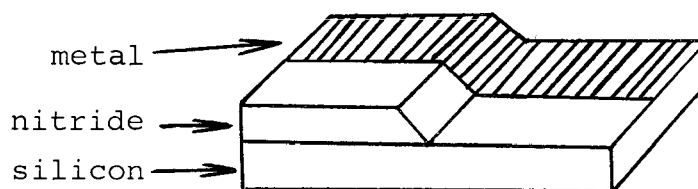

Metallized Silicon Sample

#### B. Two-Beam Interference Method With Non-Metallized Sample

To measure the index of refraction of the silicon nitride films, the non-metallized sample method was used in addition to the metallized method. In the non-metallized method, the metallized silicon substrates that had been used previously were placed under the microscope. This time the non-metallized portion of the sample was examined near the intersection of the metallized and non-metallized sections. A system of fringes was observed

and the film thickness could be calculated by (6, p. 1207)

$$d = q \frac{\lambda}{2(n - 1)}$$

where  $d$  = the thickness of the silicon nitride film

$n$  = the refractive index of the nitride film

$q$  = the fringe displacement

$\lambda$  = the wavelength of the monochromatic light.

Since the film thickness had already been measured by the metallized method, this leaves only the index of refraction as an unknown in the equation above. This was the method used to determine the index of refraction of the silicon nitride films.

## V. SOME SILICON NITRIDE PROPERTIES

Some of the properties of the reactively sputtered films of silicon nitride were investigated. These properties include: infrared spectrum, etching tests, and index of refraction.

### A. Infrared Spectroscopy

The only possible film that could be reactively sputtered using only nitrogen is silicon nitride contaminated with silicon monoxide or silicon dioxide due to traces of oxygen and water in the sputtering system. This was confirmed by Hu (17, p. 694) and by Chaikin and St. John (8, p. 39). Infrared spectroscopy was one of the methods used for this confirmation.

Infrared spectroscopy was used in this project to compare the infrared spectra of reactively sputtered silicon nitride films with the infrared spectra of silicon dioxide and silicon monoxide. All infrared spectra were taken on a model IR-7 chart recording infrared machine manufactured by Beckman Instruments, Inc. The spectra were redrawn to fit the page requirements of this report.

Figure 3 shows the infrared spectra of a reactively sputtered silicon nitride film, a thermally grown (using dry oxygen at 1150° C) silicon dioxide film, and a

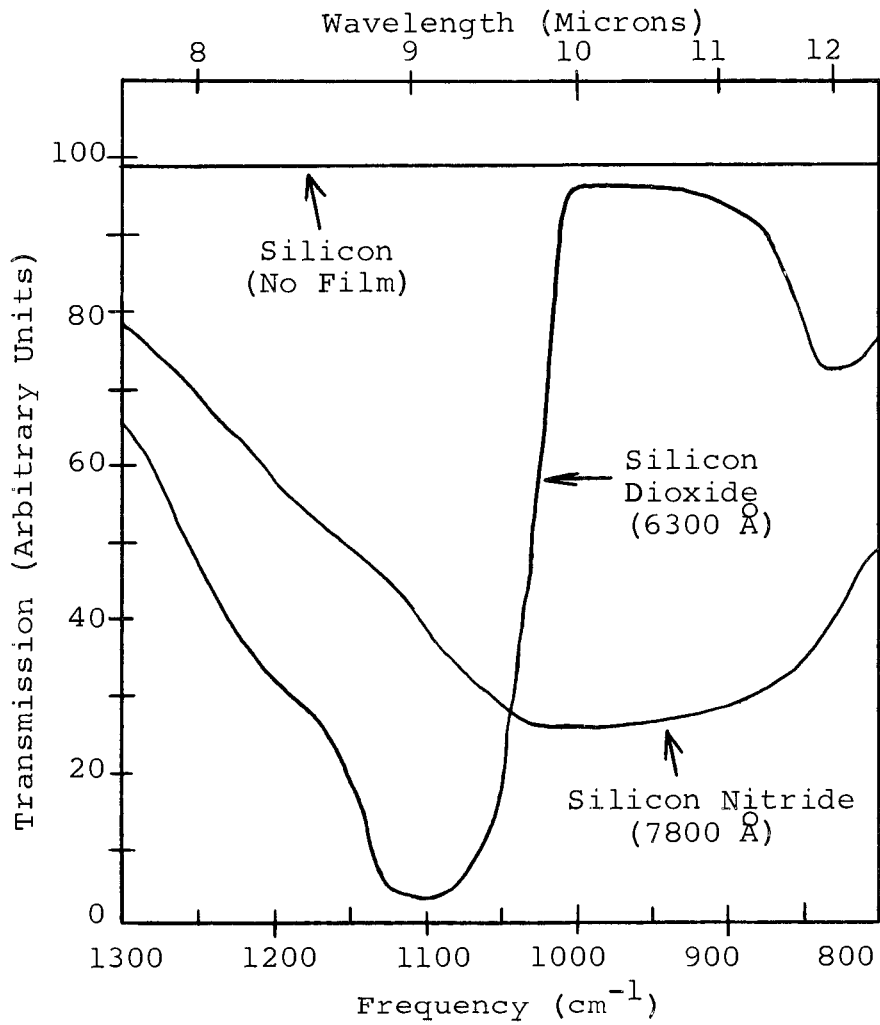

Figure 3. Infrared absorption spectra for similar silicon substrates. The spectra of silicon dioxide, silicon nitride, and no film are shown.



silicon substrate with no film on it. Both the silicon nitride and silicon dioxide films were deposited on 3/4 inch diameter silicon wafers of transistor grade. These silicon wafers were of the same thickness (ten mils) and from the same crystal. The wafers had been previously etched to provide a smooth surface, and they had been cleaned using the substrate cleaning procedure prior to deposition. The thickness of the silicon dioxide film was measured to be  $6300 \text{ \AA}$ , and the silicon nitride film thickness was  $7800 \text{ \AA}$ . The silicon nitride film had an absorption maximum over the frequency range of 950 to  $1025 \text{ cm}^{-1}$ . The silicon dioxide absorption maximum occurred over the frequency range of 1090 to  $1120 \text{ cm}^{-1}$ . As can be seen, the wafer with no film produced a straight line spectrum.

Figure 4 also shows the infrared spectra of a silicon nitride film, a silicon dioxide film, and a silicon substrate with no film. In this case, a one inch diameter silicon wafer of transistor grade was scribed and broken into three pieces. The silicon nitride film was sputtered onto one of these pieces, and the silicon dioxide film was thermally grown on another piece. Thus, the films were put on substrates that came from the same wafer. The thickness of the silicon dioxide film was  $3300 \text{ \AA}$ , and the silicon nitride film thickness was

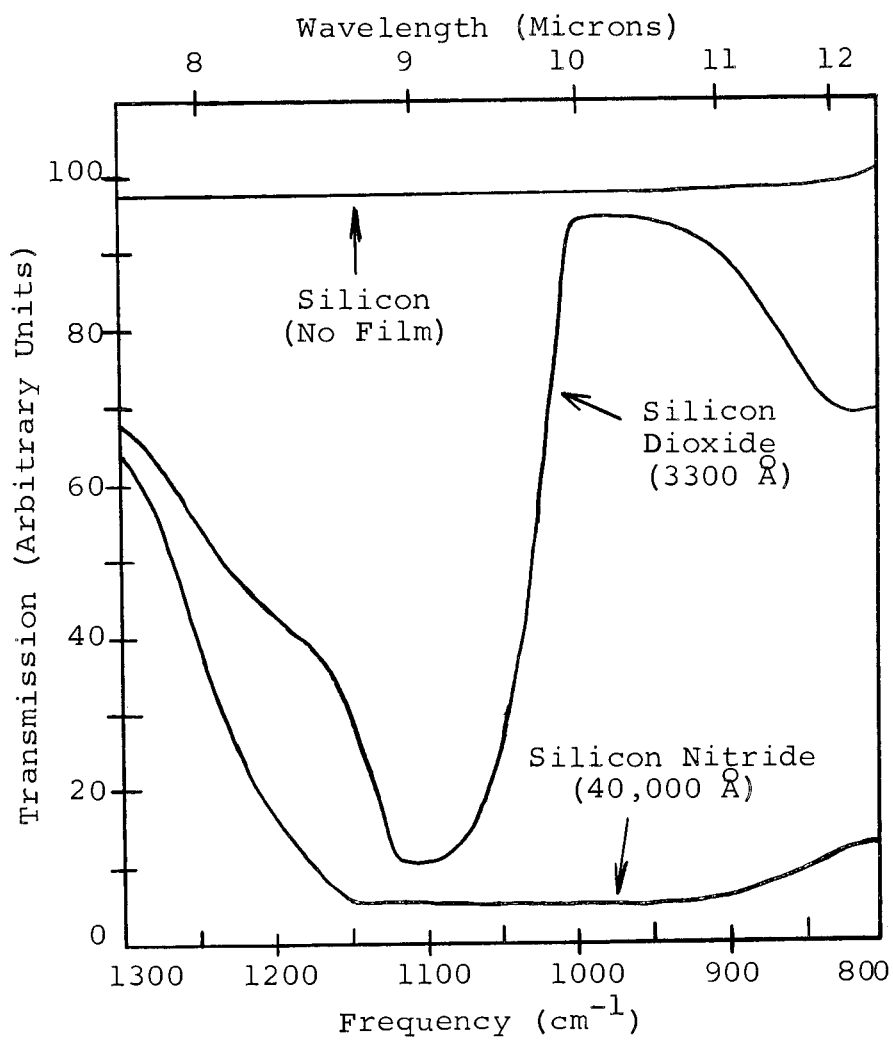

Figure 4. Infrared absorption spectra for identical silicon substrates. The spectra for silicon dioxide, silicon nitride, and no film are shown.

40,000 Å. The nitride film had an absorption maximum over the frequency range of 950 to 1140  $\text{cm}^{-1}$ . The dioxide absorption maximum occurred over the frequency range of 1100 to 1120  $\text{cm}^{-1}$ . The substrate with no film again produced a fairly straight line.

The infrared tests gave very satisfactory results. The infrared spectra of the silicon dioxide films agree with the spectra reported by Pliskin and Lehman (24, p. 1018). As can be seen from the infrared spectra, the silicon nitride films differ greatly from the silicon dioxide films. The silicon nitride spectra also differ greatly from the spectra of silicon monoxide as reported by Pliskin and Lehman (24, p. 1016).

In comparing the silicon nitride spectrum in Figure 3 with the spectrum in Figure 4, one notices that the 40,000 Å film has a spectrum whose maximum absorption band extends over a greater frequency range than that of the 7800 Å film. A reason for this may be the shifting of the Si-N stretching band as discussed by Hu (17, p. 695). Other than this feature, the spectra are very similar in shape. The infrared absorption spectrum obtained by Hu (17, p. 695) for d.c. reactively sputtered films of silicon nitride is shown by the sketch on the next page.

The spectra of the silicon dioxide films in Figures

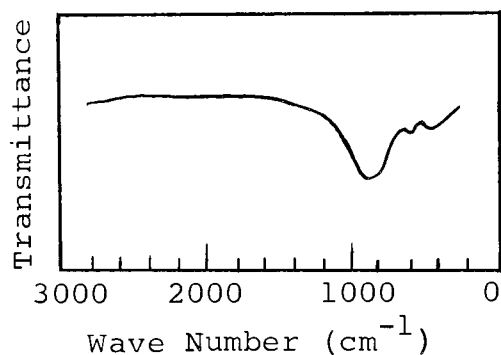

3 and 4 compare very closely. It should also be noted that the transmission decreases as the film thickness increases, which can be expected.

#### B. Etching Tests

Various reagents were used to test the silicon nitride films to determine whether they could be etched or dissolved. The procedure that was used during the testing and the results of these tests were as follows.

Silicon nitride films were reactively sputtered on two silicon wafers that had been previously cleaned. One half of the silicon nitride film was then etched off each wafer (using Apiezon W wax and 48% HF) to produce a step for film thickness measurement. This process was described previously in Section IV. The wafers were then metallized, and the film thicknesses were measured by the two-beam interference method. One wafer had a 4550 Å film, and the other wafer had a 10,320 Å film thickness.

The wafers were immersed in 10% sodium hydroxide to dissolve the aluminum film.

The two wafers were then simultaneously placed into cold beakers of various reagents. The wafers were allowed to remain in each reagent for 30 minutes. After the wafers were removed from each reagent, they were carefully rinsed with de-ionized water and dried with bibulous paper. The wafers were metallized with aluminum, and the film thickness on each wafer was measured. It was found that the silicon nitride films were resistant to etching by each of the following cold reagents: concentrated  $\text{HNO}_3$ , aqua regia, concentrated  $\text{HCl}$ , concentrated  $\text{H}_2\text{SO}_4$ , and 50%  $\text{NaOH}$ .

The two wafers were then placed simultaneously into beakers of the boiling reagents. The wafers were allowed to remain in each beaker for ten minutes. After the wafers were removed from each boiling reagent, they were rinsed and dried. The film thickness was again measured on each one. It was found that the silicon nitride films were resistant to etching by each of the following boiling reagents: concentrated  $\text{HNO}_3$ , aqua regia, concentrated  $\text{HCl}$ , concentrated  $\text{H}_2\text{SO}_4$ , and 50%  $\text{NaOH}$ .

These two wafers were then placed into a beaker of 48% hydrofluoric acid. It could be seen that the acid immediately began to react with the films. The wafers

were removed from the acid after 60 seconds. The wafers were then thoroughly rinsed and dried. No film remained on either of the wafers.

The conclusion from these etching tests is that the silicon nitride films could be rapidly etched by 48% HF, but they were resistant to etching by any of the following cold or boiling reagents: concentrated  $\text{HNO}_3$ , aqua regia, concentrated HCl, concentrated  $\text{H}_2\text{SO}_4$ , and 50% NaOH. These same results have been reported for  $\text{Si}_3\text{N}_4$  (7 and 31).

### C. Index of Refraction Measurement

Silicon nitride films of varying thickness were sputtered onto the cleaned silicon wafers. The index of refraction of these silicon nitride films was measured using the optical interference methods described in Section IV. Sodium light ( $\lambda = 5890 \text{ \AA}$ ) was used for a monochromatic light source. A sample calculation of the index of refraction is shown in the Appendix. The results of these measurements are shown in Table I.

As can be seen from the table, the index of refraction increased as the film thickness increased. A reason for this may be that the density of the films increased. The average value of index of refraction for the ten samples was approximately  $n = 1.8$ . Barnes and Geesner

Table I. Index of Refraction Measurements  
of Silicon Nitride Films.

Sample No.	Metallized Fringe Displacement (No. Fringes)	Silicon Nitride Film Thickness (Å)	Non-Metallized Fringe Displacement (No. Fringes)	Index of Refraction
1	1.2	3,540	0.8	1.67
2	1.8	5,310	1.3	1.72
3	2.6	7,670	1.9	1.73
4	3.2	9,430	2.4	1.75
5	3.5	10,310	2.7	1.77
6	4.2	12,380	3.4	1.81
7	5.0	14,700	4.2	1.84
8	5.4	15,900	4.7	1.87
9	6.0	17,700	5.3	1.88
10	6.8	20,000	6.2	1.91

(1, p. 100) reported a relative dielectric constant of  $K = 12.7$  for pyrolytically deposited  $\text{Si}_3\text{N}_4$  films. Since  $\epsilon = n^2$ , the index of refraction was approximately 3.56. Feldman and Hacskaylo (11, p. 1460) reported a relative dielectric constant of 4.2 for vacuum evaporated  $\text{Si}_3\text{N}_4$  films. Therefore, the index of refraction was approximately 2.05. Hu (17, p. 696) reported an index of refraction of 2.05 for reactively sputtered silicon nitride films. Thus, the index of refraction values obtained in this project do not seem unreasonable.

#### D. Miscellaneous

The adhering property of the silicon nitride films was briefly investigated. "Scotch" tape was firmly

applied to the film on a substrate, and then the tape was pulled off. The film remained firmly attached to the substrate. The film could not be rubbed off, and it was difficult to scratch the film with a steel point. These tests were tried on films deposited on both glass and silicon substrates.

During the sputtering process, a film of silicon nitride is deposited onto the side of the pyrex pipe section of the sputtering module. This film must be taken off regularly to provide clear observation of the substrate during sputtering. Since the silicon nitride films could be etched only by hydrofluoric acid, a 20% solution of HF was used to clean the pyrex pipe section. A few drops of this solution was applied to the silicon nitride film and then rinsed off quickly with water to prevent the pyrex pipe from being etched. This was repeated until most of the film had been removed from the pyrex.



## VI. SPUTTERING PROPERTIES OF SILICON NITRIDE

Many parameters affect the rate at which films are deposited by sputtering. Most of the primary factors which determine how the sputtered atoms are generated and how they diffuse to the substrate are very complex. It requires special equipment to measure these parameters. Therefore, many researchers have only measured what are called secondary parameters. These secondary parameters are: applied voltage, gas pressure, cathode-to-substrate distance, and time. Since the author had neither the specialized equipment nor the required knowledge of gaseous discharge and momentum transfer theory, only secondary parameters were measured in this project.

Since the silicon nitride film thickness was found to vary across the substrates, the maximum film thickness was used for plotting most of the curves shown in this project. The maximum film thickness occurred directly under the center of the cathode.

### A. The Effect of Cathode-Substrate Distance on Film Thickness

Figure 5 (Table V) shows the curve of maximum film thickness as a function of the cathode-to-substrate distance using the aluminum substrate holder. In this case, the substrate was actually resting on the anode

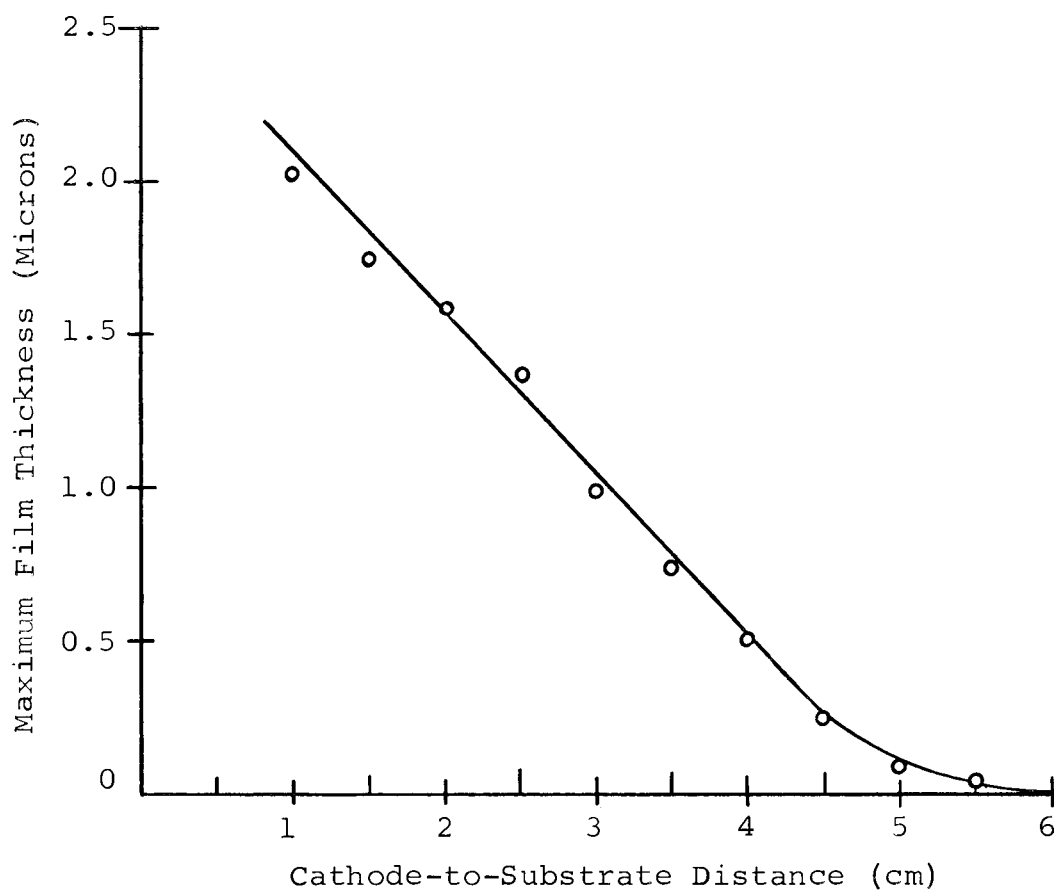

Figure 5. Maximum film thickness versus cathode-to-substrate distance using an aluminum substrate holder. The films were deposited on glass substrates, and sputtering time was four hours. Sputtering conditions were: nitrogen pressure of  $5 \times 10^{-2}$  torr, 2000 V, 30 ma, and the cathode-to-anode distance is the same as the cathode-to-substrate distance.

(aluminum substrate holder); and thus, the cathode-to-anode distance is the same as the cathode-to-substrate distance. The sputtering conditions are given on the figure. Nitrogen gas (99.997%) was used here as it was for almost all the curves. It is noted that the maximum film thickness varies linearly with cathode-to-substrate distance for most of the curve. The deviation after five centimeters may be due to inaccurate measurement of the very thin films. Since the cathode-to-anode distance was varied, the sputtering conditions were being changed. Although most researchers had the substrate resting on the anode, no curves of film thickness versus cathode-to-substrate distance could be found for comparison purposes.

As the substrate was brought closer than one centimeter from the cathode, the anode penetrated the cathode dark space; and the glow discharge was extinguished. This was reported by Holland (15, p. 420).

It should be stated that it was very difficult to control the glow discharge when using the aluminum substrate holder. After sputtering for about an hour at cathode-to-substrate distances less than four centimeters, the system had a tendency to arc; and the glow discharge would blink off and on again at irregular intervals. The reason for this was not found.

Figure 6 (Table VI) shows the curve of maximum film thickness as a function of the cathode-to-substrate distance using the glass substrate holder. The sputtering conditions are given on the figure. This curve has a somewhat different shape than the curve (Figure 5) using the aluminum substrate holder. A parabolic relationship is represented by the curve in Figure 6. This parabolic relationship agrees with the findings of a number of investigators. Holland (15, p. 422) states that:  $Q \propto \frac{1}{dp}$  where  $Q$  is the amount of material deposited per unit time,  $d$  is the cathode-receiver distance, and  $p$  is the sputtering pressure.

It should be stated that it was much easier to control the glow discharge using the glass substrate holder than it had been using the aluminum substrate holder. The system remained very stable, and the sputtering system could be operated for periods of more than 20 hours without arcing. Also, the substrate could be placed in the cathode dark space without extinguishing the glow discharge. For these reasons, the glass substrate holder was used for almost all of the experiments in this project.

#### B. The Effect of Applied Voltage on Film Thickness

A curve of maximum film thickness as a function of the applied voltage is shown in Figure 7 (Table VII).

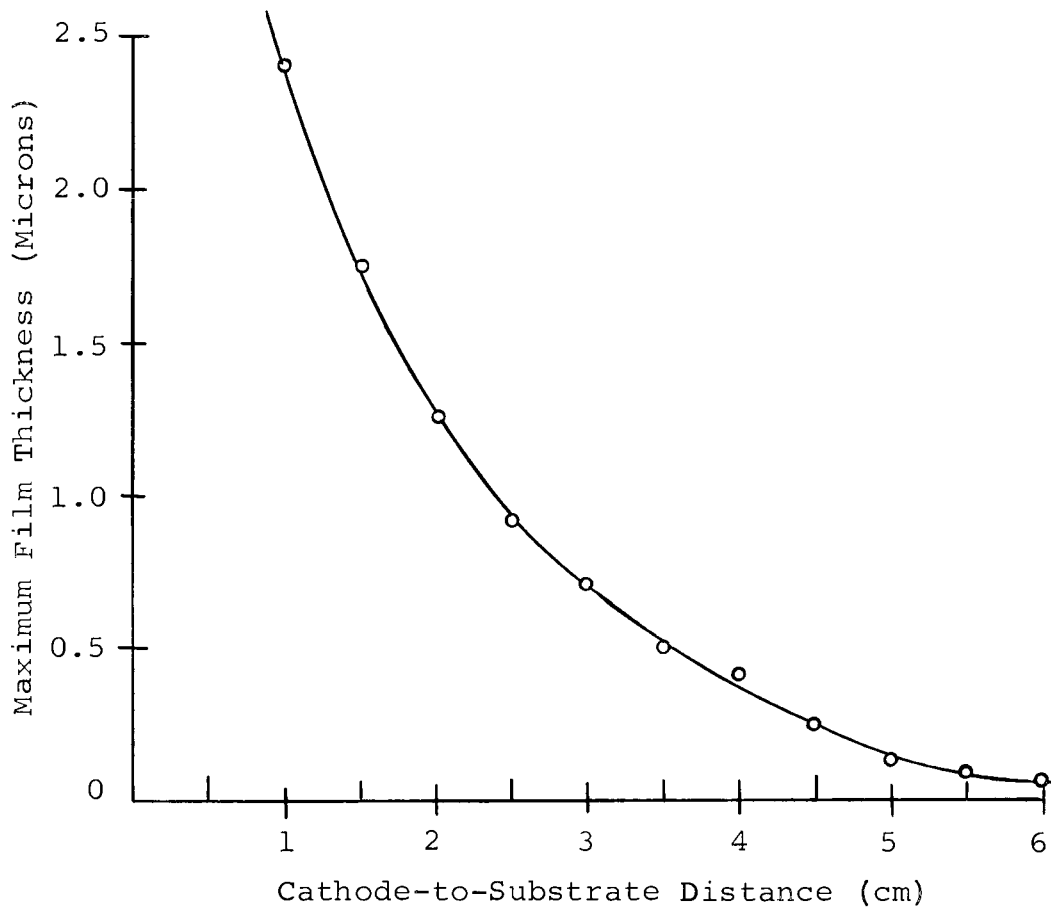

Figure 6. Maximum film thickness versus cathode-to-substrate distance using a glass substrate holder. The films were deposited on glass substrates, and sputtering time was four hours. Sputtering conditions were: nitrogen pressure of  $5 \times 10^{-2}$  torr, 2000 V, 30 ma, and a cathode-to-anode distance of 11 cm.

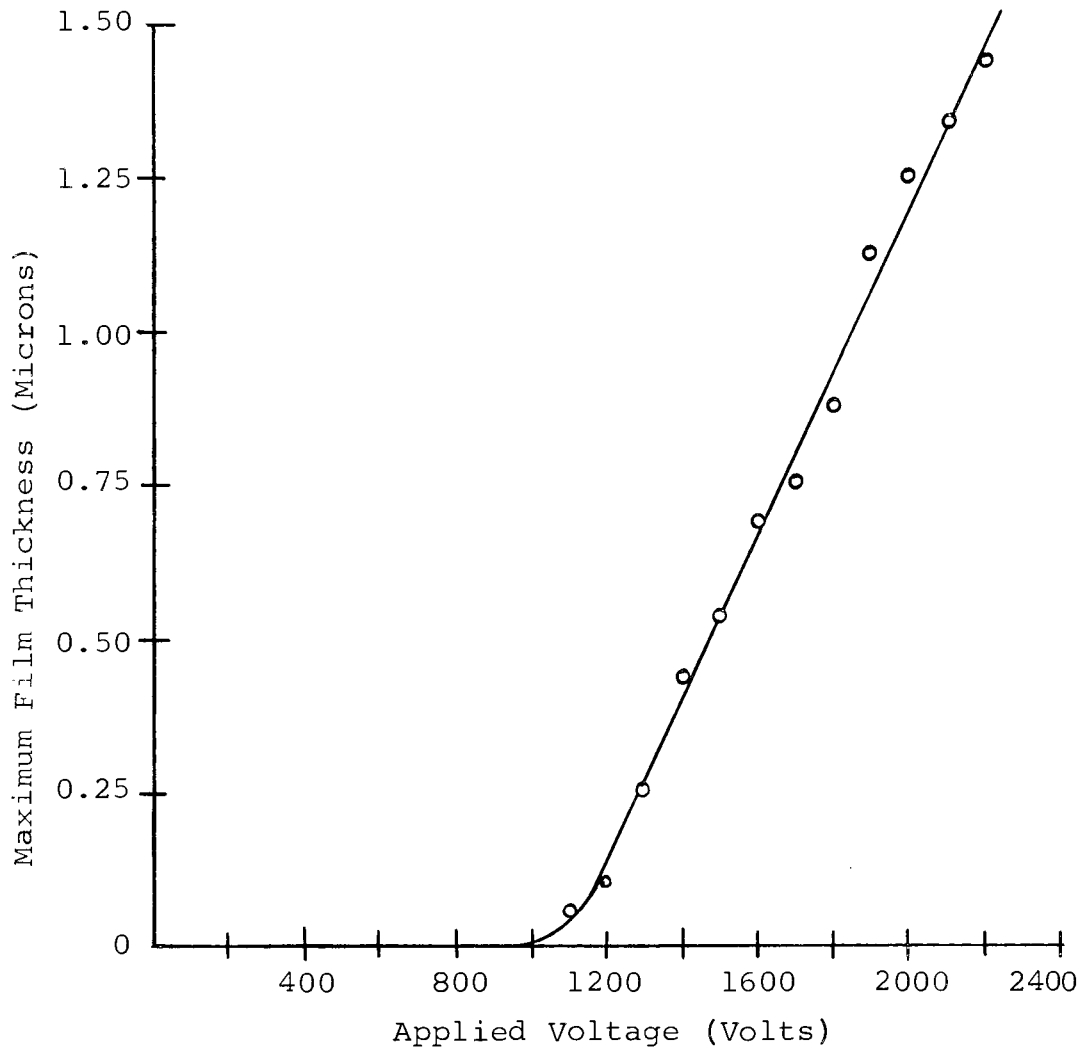

Figure 7. Maximum film thickness versus applied voltage. A glass substrate holder was used, and the films were deposited on glass substrates. Sputtering conditions were: nitrogen pressure of  $5 \times 10^{-2}$  torr, distance between dark space and substrate of 0.5 cm, and a cathode-to-anode distance of 11 cm. Sputtering time was four hours.

As with the two previous curves, the sputtering time was four hours. As the applied voltage was increased, the cathode dark space receded slowly toward the cathode. To compensate for this, the cathode-substrate distance was readjusted to keep the substrate just outside the cathode dark space. The distance between the substrate and cathode dark space was kept at a constant 0.5 cm. The other sputtering conditions are given on the figure. As can be seen, there is an almost linear relationship between the film thickness and the applied voltage. The curve departs slightly from this linear relationship at voltages less than 1200 volts. The film thickness becomes negligible below 1000 volts. This experimental relationship agrees with the findings of numerous investigators (15, p. 404 and 4, p. 25). According to Blevis (4, p. 26), the applied voltage relationship can be approximated by:  $T = a(V - V_0)t$ , where  $T$  is the film thickness,  $V$  is the applied voltage,  $t$  is the deposition time, and  $a$  and  $V_0$  are material and substrate dependent constants. Above 2200 volts, the glow discharge went into arc discharge.

### C. The Effect of Gas Pressure on Film Thickness

Figure 8 (Table VIII) shows the curve of maximum film thickness as a function of gas pressure. The

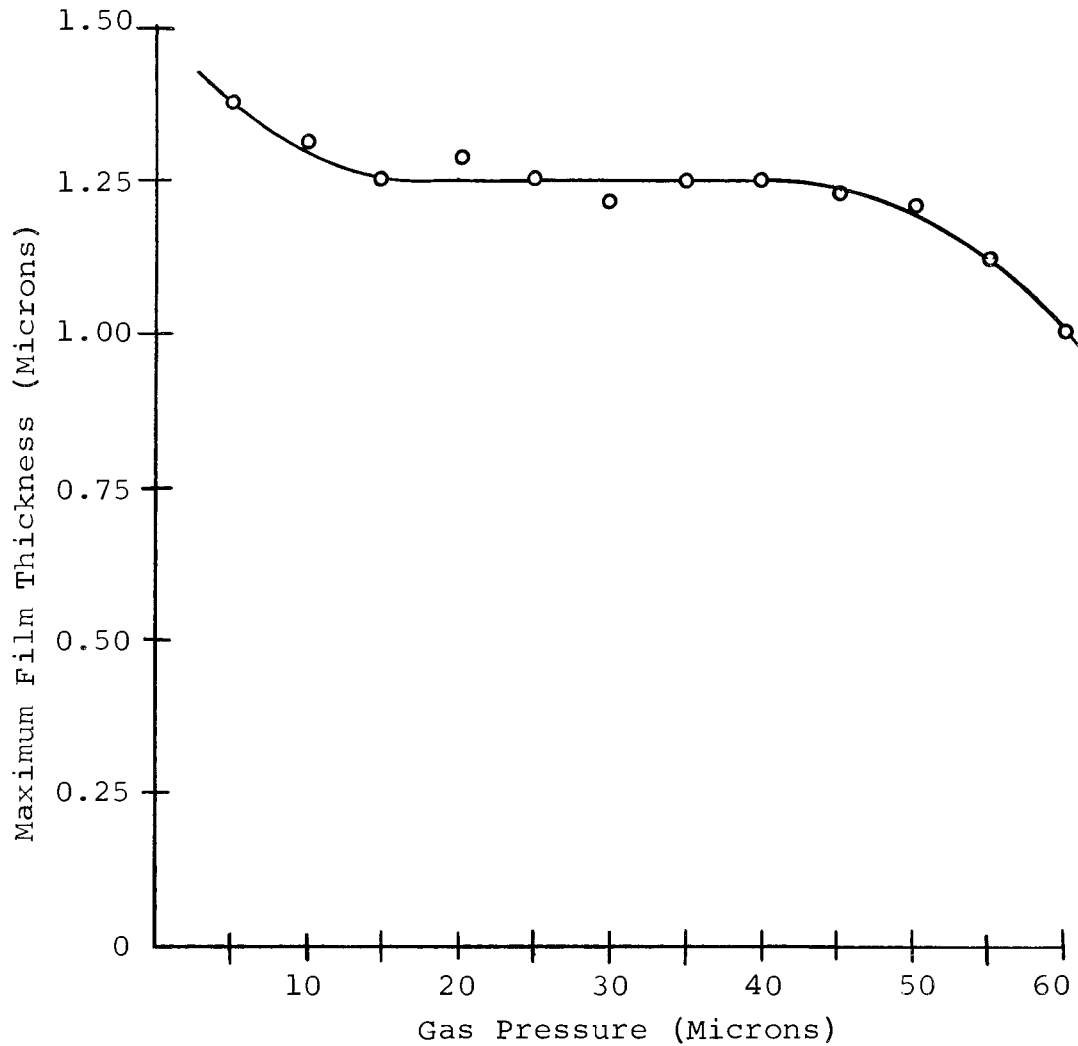

Figure 8. Maximum film thickness versus gas pressure. A glass substrate holder was used, and the films were deposited on glass substrates. Sputtering conditions were: 2000 V, a cathode-to-substrate distance of 2 cm, and a cathode-to-anode distance of 11 cm. Sputtering time was four hours.



cathode-to-substrate distance was kept at a constant two centimeters. As the gas pressure was increased, the cathode dark space contracted toward the cathode; and the current increased. This produced the rather odd-shaped curve shown. Similar curves have been obtained by other investigators (29, p. 260-261). Holland (15, p. 425) states that the sputtering rate may be given by the relation:

$$Q = \frac{K_p i_+ t}{p d}$$

where  $K_p$  is a constant depending on the material of the cathode and cathode voltage;  $p$  is the gas pressure in mm Hg;  $i_+$  is the positive ion current density in amps/cm<sup>2</sup>;  $d$  is the gap between the plates in cm; and  $t$  is the sputtering time in hours. Thus, if the current increases as the pressure increases, one can see that a curve such as the one shown in Figure 8 could be obtained.

#### D. The Effect of Sputtering Time on Film Thickness

The curve of maximum film thickness as a function of sputtering time using glass substrates is shown in Figure 9 (Table IX). Nitrogen 99.997% was used. The cathode-to-substrate distance was kept at two centimeters. The rest of the sputtering conditions are shown on the figure. The average sputtering rate was 50 Å per minute.

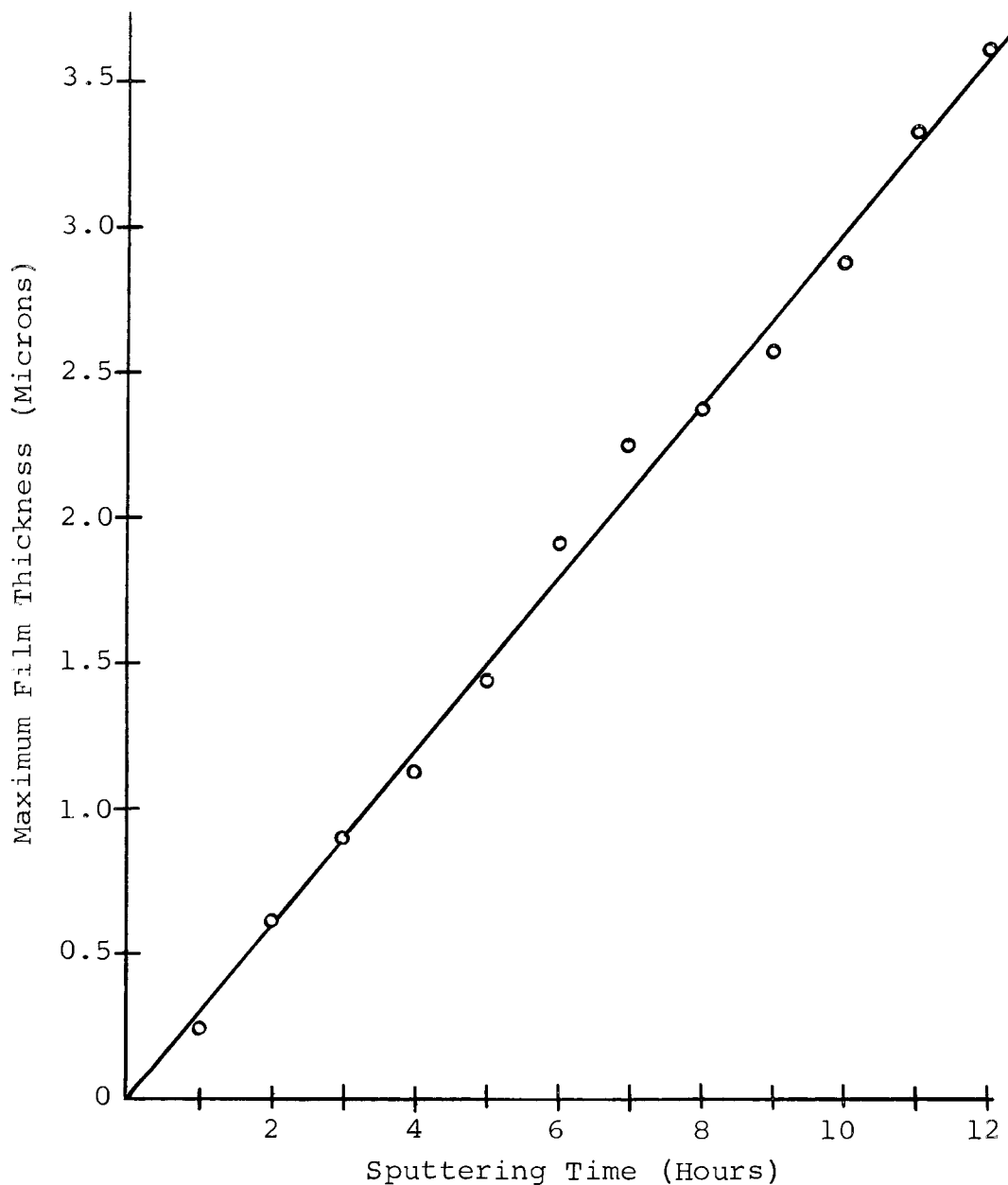

Figure 9. Maximum film thickness versus sputtering time using glass substrates. A glass substrate holder and 99.997% nitrogen were used. Sputtering conditions were: nitrogen pressure of  $5 \times 10^{-2}$  torr, 2000 V, 30 ma, and a cathode-to-substrate distance of 2 cm. The average sputtering rate was 50 Å per minute. The cathode-to-anode distance was 11 cm.

Figure 10 (Table X) shows the curve of maximum film thickness as a function of sputtering time using 50% argon-50% nitrogen. The films were deposited on glass substrates. The gas pressure was kept at  $5 \times 10^{-2}$  torr as was used for most of the other curves. The argon and nitrogen were mixed inside of the sputtering chamber. The average sputtering rate was  $100 \text{ \AA}$  per minute. Due to the larger atomic weight of argon, the sputtering rate was doubled over the value obtained using only nitrogen. Similar results were reported by Sinclair and Peters (26, p. 22) and by Holland (15, p. 415).

The curve of maximum film thickness as a function of sputtering time using silicon substrates is shown in Figure 11 (Table XI). Nitrogen (99.997%) was used. The same sputtering conditions were used as had been used for the previous two sputtering rate curves. The average sputtering rate was  $46 \text{ \AA}$  per minute. This rate is close to the value that had been obtained when using glass substrates which shows that very little thermal film growth took place inside the sputtering module during the sputtering process.

As can be seen from these three sputtering rate curves, there is a linear relationship between the film thickness and sputtering time. This has been reported by a number of investigators (15, p. 413 and 26, p. 22).

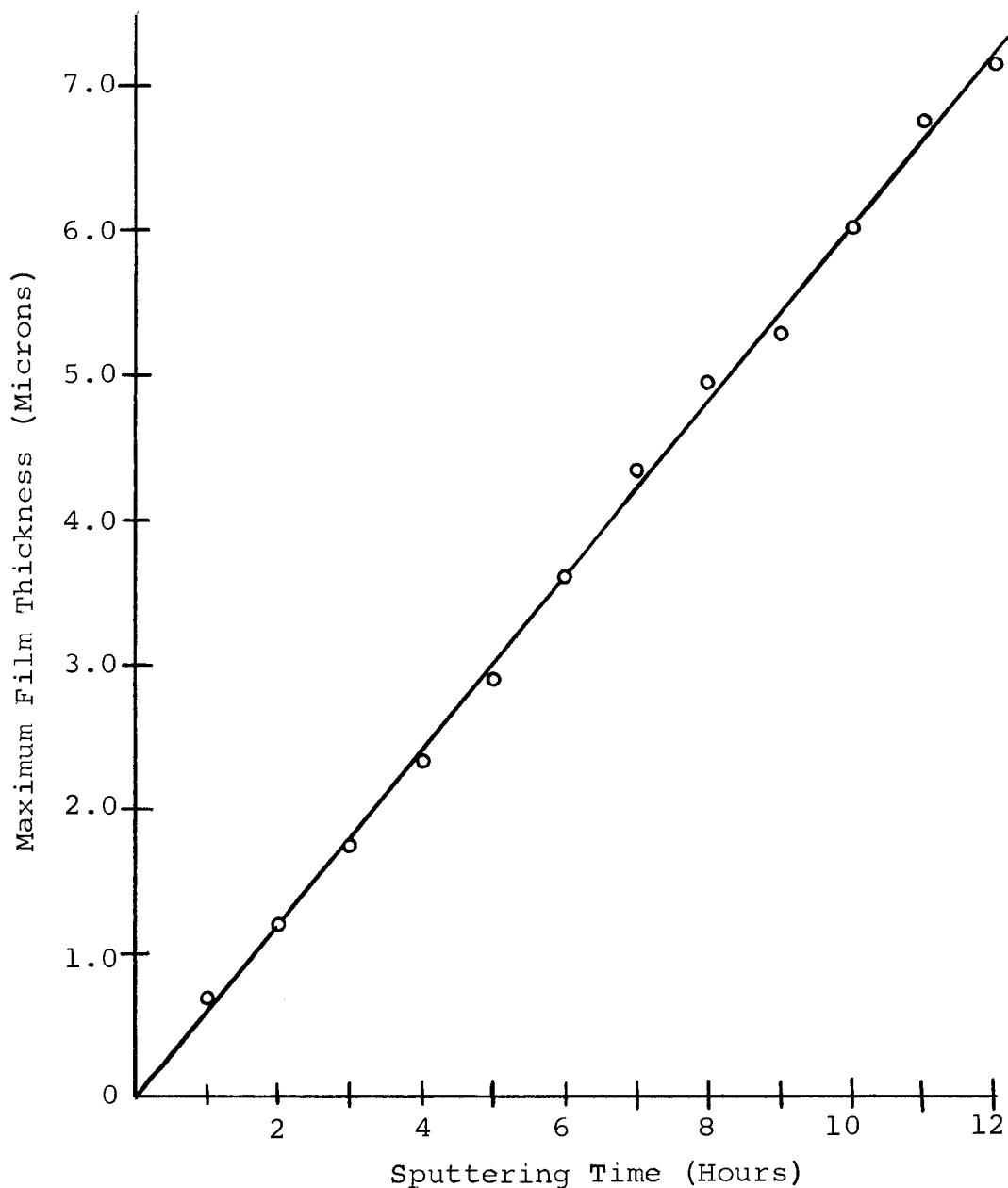

Figure 10. Maximum film thickness versus sputtering time using 50% argon-50% nitrogen. A glass substrate holder was used. Sputtering conditions were: gas pressure of  $5 \times 10^{-2}$  torr, 2000 v, 30 ma, and a cathode-to-substrate distance of 2 cm. The average sputtering rate was  $100 \text{ \AA}$  per minute. The cathode-to-anode distance was 11 cm. The films were deposited on glass substrates.

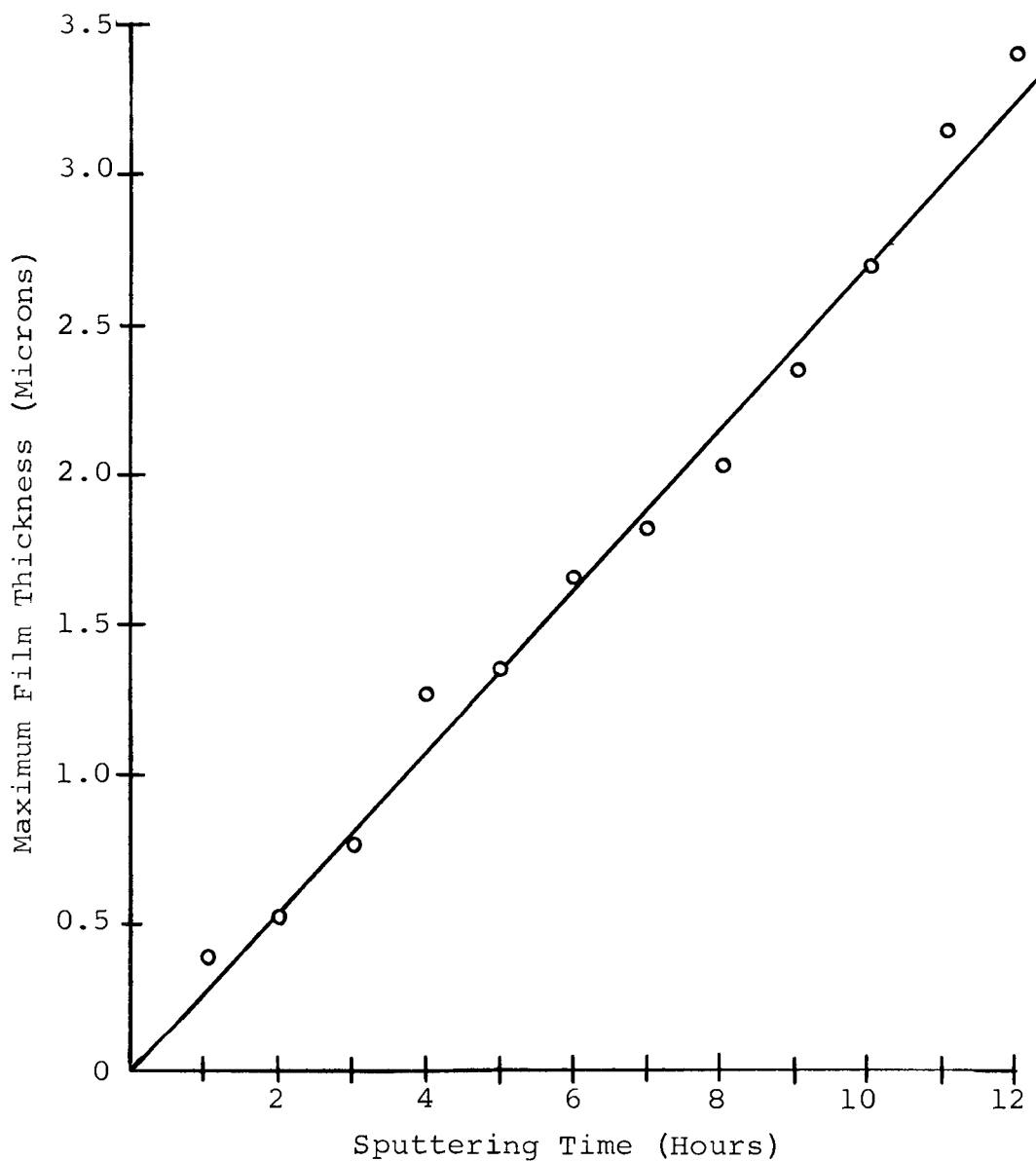

Figure 11. Maximum film thickness versus sputtering time using silicon substrates. 99.997% nitrogen was used. Sputtering conditions were: nitrogen pressure of  $5 \times 10^{-2}$  torr, 2000 V, and 30 ma. A glass substrate holder was used with cathode-to-substrate distance of 2 cm. The average sputtering rate was 46 Å per minute. The cathode-to-anode distance was 11 cm.

Blevis (4, p. 26) reported that the relationship between film thickness and sputtering time may be approximated by:  $T = a(V - V_0)t$  where  $a$  and  $V_0$  are material and substrate dependent constants,  $T$  is the film thickness,  $V$  is the applied voltage, and  $t$  is the deposition time. The sputtering rate values obtained in this project are in the same range as had been obtained for silicon dioxide by Sinclair and Peters (26, p. 22).

#### E. Uniformity of the Sputtered Films

Although uniformity is not an absolute requirement for a diffusion mask, it would be desirable from the standpoint of etching purposes to have uniformly sputtered films. It is therefore important to investigate the thickness distribution of the silicon nitride films.

When viewed under white light, the sputtered silicon nitride films on silicon wafers had annular rings of various interference colors which could be seen by the eye. These annular rings of interference colors were caused by the gradual variation of thickness of the silicon nitride film across the wafer. As the film thickness increased, these annular rings became narrower and closer together. At a film thickness of 40,000 Å, the silicon nitride films look almost transparent. This transparent condition for thick films of pyrolytically

deposited  $\text{Si}_3\text{N}_4$  was reported by Barnes and Geesner (1, p. 99).

In order to obtain data for studying the thickness distribution of the sputtered films, a precleaned 2.8 cm (1.1") diameter silicon wafer was placed on the glass substrate holder in the sputtering module. A silicon nitride film was sputtered on the wafer for a period of four hours. Using the Apiezon wax solution and 48% hydrofluoric acid, a five millimeter stripe was etched across the wafer (through the center). The thickness of the silicon nitride film was then measured at one millimeter intervals using the two-beam interference method with metallized sample.

Figure 12 (Table XII) shows the curve of film thickness as a function of the distance from the center of the cathode. The cathode-to-substrate distance used for this experiment was two centimeters. As can be seen, the film thickness varies considerably across the wafer. The film remains uniform at  $9600 \text{ \AA}$  for about one centimeter. Since the cathode wafer was 1.5" in diameter, the uniform film distance was about one-fourth of the cathode diameter. Similar results were reported by Holland (15, p. 424) and by Blevis (4, p. 23).

The sputtered films could be made somewhat more uniform by decreasing the cathode-to-substrate distance,

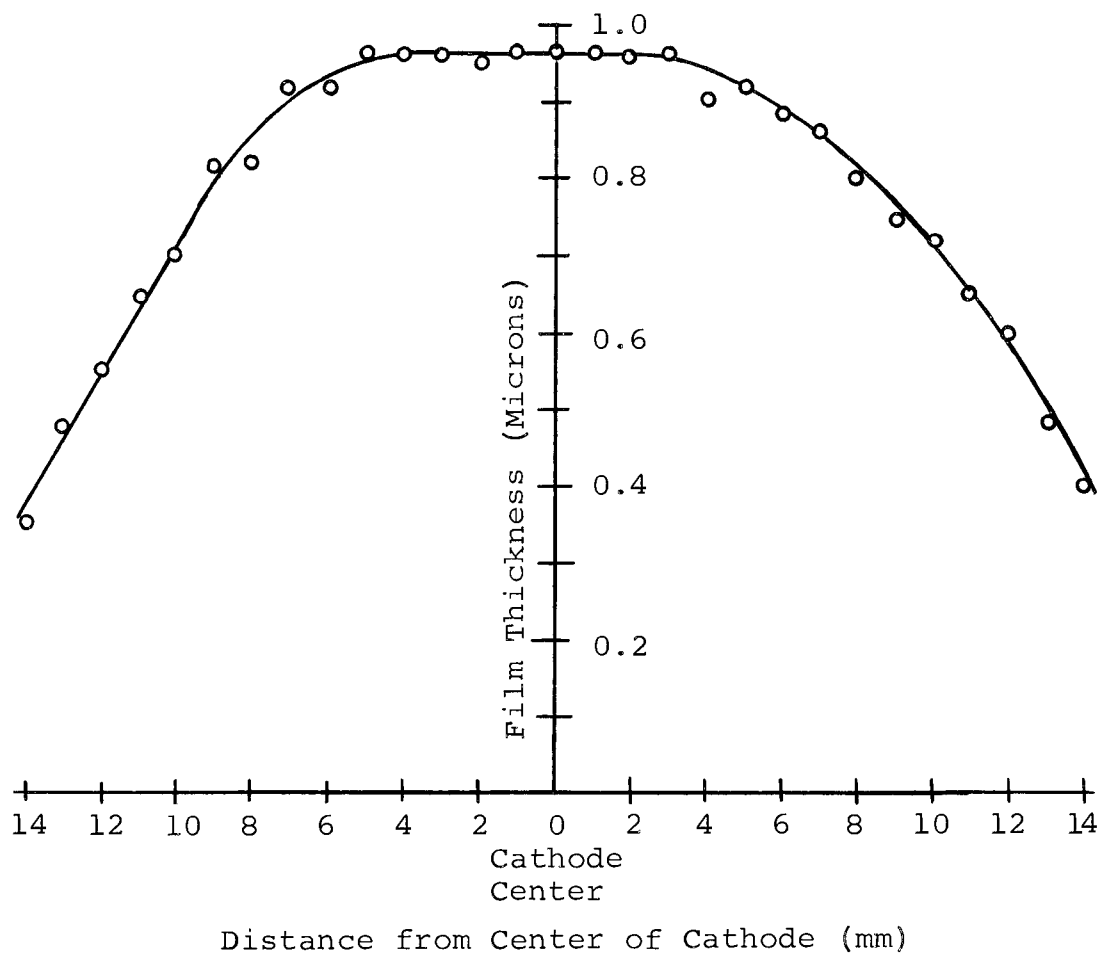

Figure 12. Film thickness versus distance from center of the cathode. A 2.8 cm diameter silicon wafer was used. The cathode-to-substrate distance was 2 cm. A glass substrate holder was used, and the sputtering time was four hours. Sputtering conditions were: nitrogen pressure of  $5 \times 10^{-2}$  torr, 2000 V, 30 ma, and a cathode-to-anode distance of 11 cm.



but the increase in uniformity was not significant. Similar results were reported by Blevis (4, p. 23-24). Holland (15, p. 424) also reports that a more uniform coating can be obtained if the ratio of cathode diameter to receiver distance ( $D/d$ ) is increased. Since 1.5" diameter silicon wafers were the largest diameter wafers available in the laboratory for making cathodes, no further experiments on uniformity were tried. If the sputtering module was larger, then much larger diameter cathodes could be used; and the sputtered films could be made more uniform. Bloom and Sandler (5, p. 1050-1051) describe a process for making large-area silicon cathodes for reactive sputtering.

## VII. MASKING AGAINST BORON DIFFUSION IN SILICON

As was mentioned before, the Sperry Rand Corporation has reported using silicon nitride as a mask against diffusion of boron and phosphorus in silicon (20, 21, 27, and 28). These reports are very general in nature, and the details of the diffusion masking were not revealed. IBM has also used silicon nitride for diffusion masks against boron and phosphorus (10, p. 563 and 17, p. 698). It was reported that 1200 Å of pyrolytically deposited  $\text{Si}_3\text{N}_4$  and 1000 Å of reactively sputtered  $\text{Si}_3\text{N}_4$  masked effectively against boron and phosphorus using a gas type diffusion. Thus, it was considered important to study the masking ability of the reactively sputtered films of silicon nitride, obtained in this project, against boron and phosphorus diffusion in silicon. The detailed results of this research are presented here.

### A. Silicon Wafer Preparation

The 3/4 inch diameter silicon wafers that had been cleaned previously were used for this investigation. These wafers were n-type, and they had resistivities that ranged from 0.5 ohm-cm to 3 ohm-cm. Silicon nitride films of graduated thickness were sputtered on the wafers. Each wafer was then scribed and broken in half. A two millimeter strip of silicon nitride was etched off the

broken edge of each half-wafer using Apiezon W wax and 48% HF. The maximum film thickness was then measured using the two-beam interference method with metallized sample. The aluminum film was then removed from each of the half-wafers using a 10% NaOH solution, and the half-wafers were ultrasonically cleaned with detergent and rinsed in de-ionized water.

### B. The Diffusion Process

Two boron solutions were prepared for use as boron sources. One solution was composed of one gram  $B_2O_3$  in 100 ml of de-ionized water. The other solution was more dilute and was composed of one gram  $B_2O_3$  in 1000 ml of de-ionized water. These solutions were placed in polyethylene dropper bottles.

Two drops of the more concentrated solution were put on one half-wafer and spread uniformly over the surface. Two drops of the more dilute solution were placed on the matching half-wafer and spread uniformly over the surface. This process was repeated for all of the half-wafers. The water was allowed to evaporate leaving a very thin coating of  $B_2O_3$  on the surface of the half-wafers.

The half-wafers were then placed on quartz boats and placed in a tube diffusion furnace heated to 1150° C.

The diffusion process was carried on for 60 minutes. The half-wafers were then removed from the furnace and allowed to cool. By using silicon reference wafers of known resistivity, assuming a complementary error function impurity distribution, and measuring the junction depth of the diffused wafers, the surface concentrations ( $N_s$ ) of the boron sources at 1150° C were calculated to be the solid solubility of boron ( $5 \times 10^{20}$  atoms/cm<sup>3</sup>).

### C. Determining the Masking Ability of the Silicon Nitride Films

The half-wafers were then attached with wax to microscope slides, and a parabolic groove was cut on the surfaces of the half-wafers using diamond lapping paste and a cylindrical rotating rod which had been set at an appropriate angle. This parabolic groove was cut on the flat side of the half-wafers at the point of maximum silicon nitride film thickness. The parabolic groove was made so that it passed over both the silicon strip and part of the silicon nitride film. A sketch of the grooved half-wafer is shown on the following page.

After they had been grooved, the half-wafers were stained to provide a visible difference between the base material and the diffused layer. Dash Etch (12 parts acetic acid, three parts nitric acid, and one part hydrofluoric acid) was used for the staining process. The

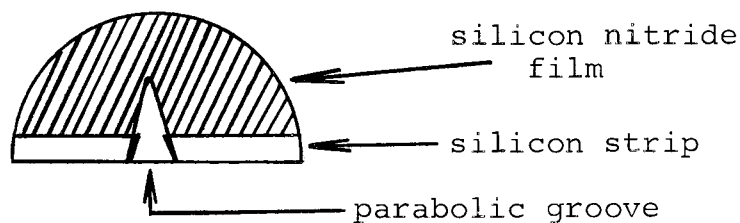

etch was applied to the area to be stained under a low-power microscope. Heat and light were used to enhance the reaction. As soon as the stain became visible, the reaction was quenched by rinsing the wafer under running water. The junction depth was measured using a filar, micrometer eyepiece attached to the Unitron metallurgical microscope.

After the staining process, the silicon nitride films were removed using 48% HF. A Westinghouse thermoelectric probe was used to test the area under the silicon nitride films to determine whether it was n-type or p-type. The results of the staining test and thermoelectric probe test are given in Table II.

As can be seen from this table, the silicon nitride films began to mask the dilute boron source at  $3800 \text{ \AA}$ . The films completely masked the dilute source at  $4480 \text{ \AA}$ . For the concentrated source, the films began to mask at  $5080 \text{ \AA}$  and completely masked the boron diffusion at  $6300 \text{ \AA}$ . The junction depth for the unmasked silicon strip remained around four microns.

Table II. Boron Diffusion Masking in Silicon Nitride.

Concentrated boron solution = 1 gm  $B_2O_3$  in 100 ml of water.  
 Dilute boron solution = 1 gm  $B_2O_3$  in 1,000 ml of water.  
 Diffusion temperature = 1150° C.  
 Diffusion time = 60 minutes.

Silicon Nitride Film Thickness (Å)	Boron Source Solution	Results of Staining Test	Results of Thermo-Electric Probe Test	Junction Depth of Unmasked Strip (Microns)
2,540	Conc.	Didn't mask	p-type	4.2
2,540	Dilute	Didn't mask	p-type	3.9
3,210	Conc.	Didn't mask	p-type	4.8
3,210	Dilute	Didn't mask	p-type	3.6
3,800	Conc.	Didn't mask	p-type	3.5
3,800	Dilute	*Masked somewhat	p-type	5.0
4,480	Conc.	Didn't mask	p-type	4.7
4,480	Dilute	Masked	n-type	3.9
5,080	Conc.	*Masked somewhat	p-type	5.0
5,080	Dilute	Masked	n-type	4.8
6,300	Conc.	Masked	n-type	3.8
6,300	Dilute	Masked	n-type	4.5
8,250	Conc.	Masked	n-type	4.1
8,250	Dilute	Masked	n-type	4.9
10,500	Conc.	Masked	n-type	4.3
10,500	Dilute	Masked	n-type	3.5

\* Masked somewhat means that the junction depth of the masked portion was less than the junction depth of the unmasked portion.

## VIII. MASKING AGAINST PHOSPHORUS DIFFUSION IN SILICON

Like boron, phosphorus is one of the most commonly used of diffusion materials for silicon. Phosphorus has a diffusion coefficient equal to that of boron.

### A. Silicon Wafer Preparation

Lapped, one-inch diameter silicon wafers were etched with CP-5 (200 parts  $\text{HNO}_3$ , 120 parts HF, and 120 parts acetic acid) to produce a smooth surface. These wafers were p-type, and they were cut from the same crystal. The resistivity of these wafers was 1.2 ohm-cm. The wafers were cleaned using the cleaning procedure discussed in Section II. Silicon nitride films of graduated thickness were reactively sputtered onto these wafers, and the rest of the wafer preparation was the same as that described in Section VII for boron masking.

### B. The Diffusion Process

Two phosphorus solutions were used for the diffusion process. One solution was a concentrated, stabilized liquid preparation called N-Diffusol, manufactured by the Transene Company of Danvers, Massachusetts. This solution has a diffusion coefficient of  $3.3 \times 10^{-12} \text{ cm}^2/\text{sec}$  at  $1150^\circ \text{ C}$ . The other phosphorus solution was a diluted form of N-Diffusol (1 ml N-Diffusol in 10 ml of

de-ionized water).

A thin layer of the concentrated solution was painted on one half-wafer with a camel's hair brush. A thin layer of the dilute solution was then painted on the matching half-wafer. This process was repeated for all of the half-wafers, and the phosphorus solution was allowed to dry, leaving a thin white layer on each half-wafer.

The half-wafers were then placed on quartz boats and placed in a tube diffusion furnace heated to  $1150^{\circ}$  C. The diffusion process was carried on for 60 minutes. The half-wafers were then removed from the furnace and allowed to cool. By using silicon reference wafers of known resistivity, assuming a complementary error function impurity distribution, and measuring the junction depth of the diffused wafers, the surface concentrations ( $N_s$ ) of the phosphorus sources at  $1150^{\circ}$  C were calculated to be the solid solubility of phosphorus ( $1.5 \times 10^{21}$  atoms/cm<sup>3</sup>).

### C. Determining the Masking Ability of the Silicon Nitride Films

The half-wafers were grooved and stained by the process described in Section VII for boron. The silicon nitride films were removed, and the thermo-electric probe was used to measure whether the area under the films was n-type or p-type. The results of the staining test and



the thermo-electric probe test are given in Table III.

As can be seen from the table, the silicon nitride films began to mask the dilute phosphorus source at 5810 Å. The films completely masked the dilute source at 6320 Å. For the concentrated source, the films began to mask at 11,230 Å and completely masked the phosphorus diffusion at 12,500 Å. The junction depth for the unmasked silicon strip varied around 3.4 microns.

It was noticed for both boron and phosphorus diffusions that the silicon nitride films after removal from the diffusion furnace appeared almost the same as before they were put in the furnace. The two millimeter silicon strips were black after removal from the furnace. This blackness is attributed to the boron and phosphorus layers on the unprotected silicon.

After removing the silicon nitride films for the thermo-electric probe test, it was noticed that the area under the silicon nitride films was still very shiny and smooth. The silicon nitride did a very good job of protecting the silicon surface.

Table III. Phosphorus Diffusion Masking in Silicon by Silicon Nitride.

Concentrated phosphorus solution=concentrated N-Diffusol.  
 Dilute phosphorus solution=1 ml N-Diffusol in 10 ml water.  
 Diffusion temperature = 1150° C.  
 Diffusion time = 60 minutes.

Silicon Nitride Film Thickness (Å)	Phosphorus Source Solution	Results of Staining Test	Results of Thermo-Electric Probe Test	Junction Depth of Unmasked Strip (Microns)
3,420	Conc.	Didn't mask	n-type	3.5
3,420	Dilute	Didn't mask	n-type	3.3
4,100	Conc.	Didn't mask	n-type	3.4
4,100	Dilute	Didn't mask	n-type	3.6
5,250	Conc.	Didn't mask	n-type	3.1
5,250	Dilute	Didn't mask	n-type	3.2
5,810	Conc.	Didn't mask	n-type	3.5
5,810	Dilute	*Masked somewhat	n-type	3.6
6,320	Conc.	Didn't mask	n-type	3.4
6,320	Dilute	Masked	p-type	3.1
8,000	Conc.	Didn't mask	n-type	3.0
8,000	Dilute	Masked	p-type	3.2
9,780	Conc.	Didn't mask	n-type	3.8
9,780	Dilute	Masked	p-type	3.6
11,230	Conc.	*Masked somewhat	n-type	3.9
11,230	Dilute	Masked	p-type	3.5
12,500	Conc.	Masked	p-type	3.5
12,500	Dilute	Masked	p-type	3.3
16,600	Conc.	Masked	p-type	3.4
16,600	Dilute	Masked	p-type	3.2
18,210	Conc.	Masked	p-type	3.6
18,210	Dilute	Masked	p-type	3.5

\* Masked somewhat means that the junction depth of the masked portion was less than the junction depth of the unmasked portion.

## IX. MASKING AGAINST ZINC DIFFUSION IN GALLIUM ARSENIDE

No published articles could be found on using silicon nitride as a mask against diffusion in GaAs. Since the reactively sputtered films of silicon nitride deposited equally well on all the substrates used, it was considered important to study the masking ability of these films against zinc diffusion in gallium arsenide.

A. Gallium Arsenide Wafer Preparation

Tellurium doped gallium arsenide (n-type) wafers were used for this investigation. The wafers were from the same crystal (111) and had a resistivity of  $7 \times 10^{-4}$  ohm-cm. Since the wafers were already lapped, they were etched in 1:1:2 Etch ( $\text{HCl}:\text{HNO}_3:\text{H}_2\text{O}$ ) for ten minutes to obtain a fairly smooth surface and to distinguish the gallium surface from the arsenic surface (the gallium surface is covered with etch pits).

The arsenic surface of some of these wafers was then mechanically polished on a Buehler Automet polisher using one micron alumina abrasive on a polishing wheel. This made a very smooth, flat surface. The arsenic side was then chemically polished using dilute bleach (one part bleach to 20 parts water) and a Geoscience fine polishing disk. The chemical polishing took about ten minutes.

Silicon nitride films of graduated thickness were

then reactively sputtered onto the arsenic side of both etched and polished wafers. Each wafer was scribed and broken into four-millimeter wide substrates. A two millimeter strip of silicon nitride was etched off each substrate using Apiezon W wax and 48% HF. The film thickness was then measured using the two-beam interference method with metallized sample. The aluminum film was removed from each substrate using a 10% NaOH solution, and the substrates were ultrasonically cleaned with detergent and rinsed in de-ionized water.

The silicon nitride films were tested for adherence to the substrates. "Scotch" tape was firmly applied to the films and then pulled off. The nitride films adhered well to all the polished substrates, but the films came off of a few of the etched substrates.

#### B. The Diffusion Process

Two zinc diffusant sources were used. One of these sources was pure zinc spheres, and the other source was zinc diarsenide powder. Diffusion was carried out in evacuated ( $1 \times 10^{-5}$  torr), sealed, three-inch long quartz ampoules at a temperature of 850° C in a tube diffusion furnace. A one mg zinc sphere was used part of the time, and three mg of zinc diarsenide was used the rest of the time as a diffusant source. These diffusant sources were

placed in the same temperature zone as the GaAs substrates. The diffusion was carried on for 20 minutes. After the diffusion step, the ampoules were removed from the hot zone and allowed to cool at room temperature. The substrates were then removed from the ampoules.

### C. Determining the Masking Ability of the Silicon Nitride Films

Parabolic grooves were cut on the surface of the substrates using the same process that was used for the silicon half-wafers (Section VII). The grooves were then **stained** with GaAs Junction Etch (ten parts  $H_2O$ , one part HF, and one part  $H_2O_2$ ). The staining process took about 15 minutes with the aid of heat and light to speed up the reaction. After the staining process, the silicon nitride films were removed using 48% HF. A Westinghouse thermo-electric probe was used to test the area under the silicon nitride films to determine whether it was n-type or p-type. The results of the staining test and thermo-electric probe test are given in Table IV.

As can be seen from the table, the results of the masking tests were not very satisfactory. The masking process was erratic. None of the etched substrates completely masked the zinc diffusion. Several of the films masked in spots while several others masked partially

Table IV. Zinc Diffusion Masking in Gallium Arsenide by Silicon Nitride.

Diffusion temperature = 850° C. Diffusion time = 20 minutes.

Substrate Preparation	Silicon Nitride Film Thickness (Å)	Zinc Source	Results of Staining Test	Results of Thermo-Electric Probe Test	Junction Depth of Unmasked Strip (Microns)
Etched	3,550	Zn	Didn't mask	p-type	8.7
Etched	8,200	Zn	Masked in spots	p-type and n-type	9.3
Etched	12,320	Zn	Partial masking	p-type	8.4
Etched	3,400	ZnAs <sub>2</sub>	Didn't mask	p-type	5.0
Etched	8,750	ZnAs <sub>2</sub>	Partial masking	p-type	5.5
Etched	11,900	ZnAs <sub>2</sub>	Masked in spots	p-type and n-type	5.1
Polished	3,420	Zn	Didn't mask	p-type	8.0
Polished	6,700	Zn	Masked	n-type	8.5
Polished	9,300	Zn	Partial masking	p-type	9.1
Polished	11,400	Zn	Masked in spots	p-type and n-type	8.2
Polished	14,560	Zn	Didn't mask	p-type	8.5
Polished	19,100	Zn	Masked in spots	p-type and n-type	8.0
Polished	3,280	ZnAs <sub>2</sub>	Didn't mask	p-type	4.7
Polished	6,300	ZnAs <sub>2</sub>	Partial masking	p-type	5.5
Polished	9,640	ZnAs <sub>2</sub>	Masked	n-type	5.1
Polished	12,130	ZnAs <sub>2</sub>	Masked in spots	p-type and n-type	6.0
Polished	14,250	ZnAs <sub>2</sub>	Masked	n-type	5.8
Polished	18,500	ZnAs <sub>2</sub>	Partial masking	p-type	5.0

(the junction depth of the masked portion was less than the junction depth of the unmasked portion).

The polished substrates seemed to mask a little better, but the results were still not good. As can be seen, some of the thinner films completely masked while much thicker films only partially masked or masked in spots.

After diffusion, the substrates, which had been diffused using the pure zinc spheres, were covered with a grey coating. The silicon nitride films were also covered with this coating. This coating was suspected to be condensed zinc and some evaporated arsenic from the substrate surface. It could not be removed effectively with HCl. The silicon nitride films could not be completely removed using 48% HF. The surfaces under the silicon nitride films were very rough and black in color.

Using the zinc diarsenide diffusant source, the silicon nitride films were just as smooth and shiny as they had been before diffusion. After removing the silicon nitride films with 48% HF, the GaAs area underneath was just as it had been after polishing. Thus, the zinc diarsenide probably prevented the arsenic from being evaporated from the substrate surface, and the silicon nitride films protected the surface of the GaAs very well.

These same diffusion tests were repeated using

evaporated silicon monoxide films, reactively sputtered silicon dioxide films, and e-gun evaporated silicon dioxide films. The same erratic results as shown in Table IV were obtained for all these films. It has been reported that only 2250 Å of evaporated SiO (33, p. 342) or 12,000 Å of reactively sputtered SiO<sub>2</sub> (25, p. 304) was needed to completely mask the diffusion of zinc in GaAs. Thus, it appears that the silicon nitride films are not at fault for the poor results obtained. The diffusion technique seems to be the reason for the films not masking completely.



## X. SUMMARY AND CONCLUSIONS

Reactively sputtered films of silicon nitride have been studied in this project. The infrared spectra of these films have been investigated and compared with the infrared spectra of silicon dioxide and silicon monoxide films. It was found that the nitride spectra differ greatly from the  $\text{SiO}_2$  and  $\text{SiO}$  spectra. Etching tests have been conducted on these nitride films using various reagents. It was found that only HF would etch the nitride films. The index of refraction of the silicon nitride films was measured using optical methods. The average index of refraction was found to be 1.8. Using the "Scotch" tape test, the films were found to adhere very well to smooth, clean substrates.

The sputtering properties of silicon nitride were studied and compared with similar reports on sputtering. Since the geometry of the sputtering system has some influence on the sputtering properties, the sputtering curves shown in this project are characteristic of this particular sputtering module and vacuum system. Since the silicon nitride films vary in thickness across the substrate, curves were obtained for maximum film thickness as a function of cathode-to-substrate distance, applied voltage, gas pressure, and time. A glass substrate holder and 100% nitrogen were used almost

exclusively for this work. The uniformity of the sputtered films was also studied. The curves obtained for silicon nitride sputtering were similar in shape and magnitudes to many published reports on sputtering.

The final area of research studied in this project was the masking capabilities of these silicon nitride films. It was found that these nitride films are good masks against the diffusion of boron and phosphorus in silicon. The minimum masking thickness was also investigated. The results of the study of zinc masking in GaAs by the silicon nitride films were not satisfactory. It appeared that the nitride films were masking, but erratic results were being obtained because of the problems involved with the diffusion technique. Arsenic seemed to be coming out of the crystal structure on the surface of the GaAs substrate, and this may have produced the rather poor results obtained. Zinc diarsenide diffusant appeared to help prevent this problem but did not completely eliminate it. More investigation should be done on GaAs before a positive conclusion is made on the zinc masking ability of the silicon nitride films. The films adhered very well to the polished GaAs substrates.

## XI. SUGGESTIONS FOR IMPROVING FUTURE INVESTIGATIONS

As is many times the case where only a limited amount of time can be spent on a project, the author could see, after evaluating the results obtained in this thesis, that there were many areas where improvements could be made in future research. Some of these improvements are in the sputtering system itself, and other improvements are merely suggestions for additional data. The author's suggestions for improving future investigations on reactively sputtered films of silicon nitride are given below:

1. A larger sputtering module should be used, and this sputtering module should have better vacuum seals. A very good commercial sputtering module (SP 110) is available from the R. D. Mathis Co. (4, p. 13). This module has a six inch diameter pipe section and would allow the use of larger diameter silicon cathodes. Also, this module has a back shield to limit sputtering to only the front surface of the cathode and to minimize power requirements.
2. With the addition of the larger sputtering module, larger diameter silicon cathodes could be used. These larger cathodes should be made using the process described by Bloom and Sandler (5, p. 1050-1051). By using these larger cathodes, more uniform film thicknesses could be obtained as described in Holland (15, p. 424). Also, these cathodes would eliminate any

possibility of sputtering aluminum from the electrodes.

3. X-ray spectroscopy should be used to examine the crystal structure of the sputtered films to determine the exact composition. An electron microscope should also be used to examine the surface structure and characteristics of the films.
4. Sputtering rates should be examined for higher applied voltages (up to four kv). The sputtering rate would probably be greatly increased.
5. Various mixtures of argon and nitrogen should be tried to determine what mixture produces the best films with the fastest sputtering rate. Here, infrared and x-ray spectroscopy would have to be used to determine the composition of the films.
6. The index of refraction of the silicon nitride films should be measured using other methods. The results of these other methods could then be compared with the index of refraction measured using optical methods.
7. After obtaining more uniform nitride films, planar diodes should be made in silicon using photo-resist and etching techniques. Also, the more uniform films would allow the films to be used as a dielectric in thin-film capacitors.
8. A color reference chart should be made. This color reference chart would show the colors of a set of standard films of different thicknesses.

9. Finally, more extensive work should be done on using the silicon nitride films as a diffusion mask in GaAs. Additional work should be done using zinc and other GaAs diffusant sources. Some of these other sources are cadmium and manganese.

## BIBLIOGRAPHY

1. Barnes, Charles R. and Charles R. Geesner. Silicon nitride thin film dielectric. *Journal of the Electrochemical Society* 107:98-100. 1960.
2. Becke, H. et al. The diffusion of zinc into gallium arsenide to achieve low surface concentrations. *Transactions of the Metallurgical Society of AIME* 230:307-310. 1964.
3. Belser, R. B. and W. H. Hicklin. Simple, rapid sputtering apparatus. *Review of Scientific Instruments* 27:293-296. 1956.
4. Blevis, Earl H. Glow discharge sputtering -- theory and practice. Long Beach, Calif., R. D. Mathis Co., 1964. 27 p.
5. Bloom, M. and N. P. Sandler. The preparation of large-area silicon cathodes for use in reactive sputtering. *Journal of the Electrochemical Society* 112:1050-1051. 1965.
6. Booker, G. R. and C. E. Benjamin. Measurement of thickness and refractive index of oxide films on silicon. *Journal of the Electrochemical Society* 109:1206-1212. 1962.
7. Brokhin, I. S. and V. F. Funke. The preparation of silicon nitride and the investigation of its properties. *Ogneupory* 22:562-566. 1957.  
(Abstracted in *Chemical Abstracts* 52:7643f. 1958)
8. Chaikin, Saul W. and Gilbert A. St. John. Reliable dielectric films for microcircuits. Menlo Park, 1965. 58 numb. leaves. (Stanford Research Institute. Material Sciences Laboratories. Data report for U. S. Army Electronics Command Contract No. DA 36-039 AMC-02204(E) SRI Project PMU-4919)
9. Cobine, James D. Gaseous conductors -- theory and engineering applications. New York, Dover Publications, Inc., 1958. 606 p.
10. Doo, V. Y. Silicon nitride, a new diffusion mask. *Institute of Electrical and Electronics Engineers Transactions on Electron Devices* 13:561-563. 1966.

11. Feldman, Charles and Michael HacsKaylo. Temperature characteristics of vacuum deposited dielectric films. *Review of Scientific Instruments* 33:1459-1460. 1962.
12. Frosch, C. J. and L. Derick. Diffusion control in silicon by carrier gas composition. *Journal of the Electrochemical Society* 105:695-699. 1958.
13. Fuller, C. S. and J. A. Ditzenberger. Diffusion of boron and phosphorus in silicon. *Journal of Applied Physics* 25:1439. 1954.
14. Gerstenberg, D. Reactive sputtering of refractory metal compounds. *Bell Laboratories Record* 42:364-369. 1964.
15. Holland, L. Vacuum deposition of thin films. New York, John Wiley & Sons, Inc., 1961. 542 p.
16. Horiuchi, Shiro and Jiro Yamaguchi. Diffusion of boron in silicon through oxide layer. *Japanese Journal of Applied Physics* 1:314-323. 1962.
17. Hu, S. M. Properties of amorphous silicon nitride films. *Journal of the Electrochemical Society* 113:693-698. 1966.
18. Ing, S. W., Jr. and W. Davern. Use of low-temperature deposited silicon dioxide films as diffusion masks in GaAs. *Journal of the Electrochemical Society* 111:120-122. 1964.
19. Kay, Eric. Impact evaporation and thin film growth in a glow discharge. *Advances in Electronics and Electron Physics* 17:245-322. 1962.
20. Knapp, Robert S. First n-channel IGFETS fabricated from new silicon nitride planar process. Sudbury, Mass., Sperry Rand Corporation, 1966. 3 numb. leaves.
21. Maguire, Thomas. Silicon's new wonder drug. *Electronics* 39:156-164. 1966.
22. Marinance, J. C. Diffused junctions in GaAs injection lasers. *Journal of the Electrochemical Society* 110:1153-1159. 1963.

23. Molnar, B., J. J. Flood and M. H. Francombe. Fibered and epitaxial growth in sputtered films of GaAs. *Journal of Applied Physics* 35:3554-3559. 1964.
24. Pliskin, W. A. and H. S. Lehman. Structural evaluation of silicon oxide films. *Journal of the Electrochemical Society* 112:1013-1019. 1965.
25. Shortes, Samuel R., J. A. Kanz and E. C. Wurst, Jr. Zinc diffusion in GaAs through SiO<sub>2</sub> films. *Transactions of the Metallurgical Society of AIME* 230:300-306. 1964.
26. Sinclair, W. R. and F. G. Peters. Preparation of oxide glass films by reactive sputtering. *Journal of the American Ceramic Society* 46:20-23. 1963.
27. Tombs, N. C. et al. A new insulated-gate silicon transistor. *Proceedings of the Institute of Electrical and Electronics Engineers* 54:87-89. 1966.
28. Tombs, Nigel C. et al. A new, insulated-gate transistor. Sudbury, Mass., The Sperry Rand Corporation, 1966. 4 p. (Basis of an oral presentation by Dr. H. A. Richard Wegner at the Institute of Electrical and Electronics Engineers International Solid State Circuits Conference, Philadelphia, Pa., on February 10, 1966)
29. Wehner, Gottfried K. Sputtering by ion bombardment. *Advances in Electronics and Electron Physics* 7:239-298. 1955.
30. Weisberg, Leonard R. Diffusion in GaAs. *Transactions of the Metallurgical Society of AIME* 230:291-296. 1964.
31. Weiss, L. and T. Engelhardt. Nitrogen compounds of silicon. *Anorganic Chemistry* 65:38. 1910. (Abstracted in *Chemical Abstracts* 4:1277. 1910)
32. Williams, E. L. Boron diffusion in silicon. *Journal of the Electrochemical Society* 108:795-798. 1961.
33. Yeh, T. H. Surface masking in gallium arsenide during diffusion. *Journal of the Electrochemical Society* 110:341-343. 1963.



## APPENDIX

Table V. Maximum Film Thickness Versus Cathode-to-Substrate Distance Using an Aluminum Substrate Holder.

Nitrogen pressure =  $5 \times 10^{-2}$  torr.      Current = 30 ma.  
 Sputtering time = 4 hours.      Applied voltage = 2,000 v.  
 Glass substrates were used.

Sample No.	Cathode-to-Substrate Distance (cm)	Fringe Displacement (No. of Fringes)	Maximum Nitride Film Thickness (Å)
1	1.0	6.9	20,320
2	1.5	6.0	17,600
3	2.0	5.5	16,100
4	2.5	4.7	13,800
5	3.0	3.4	10,000
6	3.5	2.6	7,600
7	4.0	1.7	4,920
8	4.5	0.9	2,540
9	5.0	0.3	800
10	5.5	0.2	500
11	6.0	---	Negligible

Table VI. Maximum Film Thickness Versus Cathode-to-Substrate Distance Using a Glass Substrate Holder.

Nitrogen pressure =  $5 \times 10^{-2}$  torr. Current = 30 ma.  
 Sputtering time = 4 hours. Applied voltage =  
 Cathode-to-anode distance = 11 cm. 2,000 v.  
 Glass substrates were used.

Sample No.	Cathode-to-Substrate Distance (cm)	Fringe Displacement (No. of Fringes)	Maximum Nitride Film Thickness (Å)
1	1.0	8.2	24,100
2	1.5	5.9	17,400
3	2.0	4.3	12,600
4	2.5	3.1	9,250
5	3.0	2.4	7,200
6	3.5	1.9	5,600
7	4.0	1.4	4,150
8	4.5	0.9	2,540
9	5.0	0.5	1,450
10	5.5	0.4	1,100
11	6.0	0.3	800

Table VII. Maximum Film Thickness Versus Applied Voltage.

Nitrogen pressure =  $5 \times 10^{-2}$  torr. Sputtering time =  
 Cathode-to-anode distance = 11 cm. 4 hours.  
 A glass substrate holder was used.  
 Glass substrates were used.  
 Distance between cathode dark space and substrate = 0.5 cm.

Sample No.	Applied Voltage (volts)	Fringe Displacement (No. of Fringes)	Maximum Nitride Film Thickness (Å)
1	1,000	---	Negligible
2	1,100	0.2	600
3	1,200	0.3	900
4	1,300	0.9	2,500
5	1,400	1.5	4,400
6	1,500	1.8	5,380
7	1,600	2.4	7,050
8	1,700	2.5	7,500
9	1,800	3.0	8,760
10	1,900	3.8	11,250
11	2,000	4.2	12,500
12	2,100	4.6	13,480
13	2,200	4.9	14,500
14	2,300 (arc discharge)	---	Negligible

Table VIII. Maximum Film Thickness Versus Gas Pressure.

Cathode-to-substrate distance = 2 cm. Sputtering time =  
 Cathode-to-anode distance = 11 cm. 4 hours.  
 A glass substrate holder was used. Applied voltage =  
 Glass substrates were used. 2,000 v.

Sample No.	Gas Pressure (Microns)	Fringe Displacement (No. of Fringes)	Maximum Nitride Film Thickness (Å)
1	5	4.7	13,750
2	10	4.5	13,120
3	15	4.2	12,500
4	20	4.4	12,870
5	25	4.2	12,500
6	30	4.1	12,130
7	35	4.2	12,500
8	40	4.2	12,500
9	45	4.2	12,500
10	50	4.1	12,130
11	55	3.8	11,250
12	60	3.4	10,100
13	65 (some arcing)		Negligible
14	70 (arc discharge)		Negligible

Table IX. Maximum Film Thickness Versus Sputtering Time Using Glass Substrates.

Nitrogen pressure =  $5 \times 10^{-2}$  torr. Current = 30 ma.  
 Cathode-to-substrate distance = 2 cm. Applied voltage =  
 Cathode-to-anode distance = 11 cm. 2,000 v.  
 A glass substrate holder was used.  
 Glass substrates were used.

Sample No.	Sputtering Time (Hours)	Fringe Displacement (No. of Fringes)	Maximum Nitride Film Thickness (Å)
1	1	0.9	2,540
2	2	2.1	6,300
3	3	3.1	9,100
4	4	3.9	11,500
5	5	5.0	14,600
6	6	6.5	19,250
7	7	7.6	22,400
8	8	8.0	23,700
9	9	8.7	25,600
10	10	9.8	28,900
11	11	11.3	33,200
12	12	12.3	36,250

Table X. Maximum Film Thickness Versus Sputtering Time Using 50% Argon-50% Nitrogen.

Gas pressure =  $5 \times 10^{-2}$  torr. Current = 30 ma.  
 Cathode-to-substrate distance = 2 cm. Applied voltage =  
 Cathode-to-anode distance = 11 cm. 2,000 v.  
 A glass substrate holder was used.  
 Glass substrates were used.

Sample No.	Sputtering Time (Hours)	Fringe Displacement (No. of Fringes)	Maximum Nitride Film Thickness (Å)
1	1	2.2	6,600
2	2	4.1	12,000
3	3	5.9	17,500
4	4	8.0	23,400
5	5	9.9	29,100
6	6	12.3	36,200
7	7	14.6	43,600
8	8	16.8	49,700
9	9	18.0	53,100
10	10	20.4	60,000
11	11	23.0	67,600
12	12	24.3	71,500

Table XI. Maximum Film Thickness Versus Sputtering Time Using Silicon Substrates.

Nitrogen pressure =  $5 \times 10^{-2}$  torr. Current = 30 ma.  
 Cathode-to-substrate distance = 2 cm. Applied voltage =  
 Cathode-to-anode distance = 11 cm. 2,000 v.  
 A glass substrate holder was used.  
 Glass substrates were used.

Sample No.	Sputtering Time (Hours)	Fringe Displacement (No. of Fringes)	Maximum Nitride Film Thickness (Å)
1	1	1.3	3,780
2	2	1.8	5,200
3	3	2.6	7,620
4	4	4.3	12,550
5	5	4.5	13,400
6	6	5.6	16,610
7	7	6.2	18,200
8	8	6.9	20,250
9	9	8.0	23,600
10	10	9.2	27,000
11	11	10.6	31,420
12	12	11.5	34,000



Table XII. Film Thickness Versus Distance from Center of the Cathode.

Nitrogen pressure =  $5 \times 10^{-2}$  torr. Current = 30 ma.  
 Cathode-to-substrate distance = 2 cm. Applied voltage =  
 Cathode-to-anode distance = 11 cm. 2,000 v.  
 A glass substrate holder was used.  
 A silicon substrate was used.

Distance from Cathode Center (mm)	Left of Center Nitride Film Thickness (Å)	Right of Center Nitride Film Thickness (Å)
0	9,600	9,600
1	9,600	9,600
2	9,510	9,600
3	9,600	9,600
4	9,600	9,020
5	9,600	9,150
6	9,250	8,800
7	9,250	8,650
8	8,200	8,000
9	8,200	7,450
10	7,000	7,210
11	6,520	6,500
12	5,500	6,020
13	4,750	4,850
14	3,500	4,000

Sample Calculation

1. The index of refraction value (Sample No. 1, Table I) was calculated as follows:

for metallized sample,  $d = p \frac{\lambda}{2}$  (6, p. 1206)

where  $d$  = the thickness of silicon nitride film  
 $p$  = the fringe displacement  
 $\lambda$  = the wavelength of the monochromatic light.

$$d = \frac{1.2 \times 5890}{2} = 3,540 \text{ \AA}$$

for non-metallized sample,  $d = q \frac{\lambda}{2(n-1)}$   
 (6, p. 1207)

where  $d$  = the thickness of the silicon nitride film  
 $n$  = the index of refraction of the nitride film  
 $q$  = the fringe displacement  
 $\lambda$  = the wavelength of the monochromatic light.

Solving the equation for  $n$ ,  $n = 1 + \frac{q \lambda}{2 d}$

$$n = 1 + \frac{0.8 \times 5890}{2 \times 3540} = 1.67$$