

AN ABSTRACT OF THE THESIS OF

Roger Louis Scriven for the Doctor of Philosophy Degree

in Chemistry presented on December 18, 1969

Title: Ion Pair Return Phenomena in the Thermal

Decomposition of Aralkyl Thiocarbonates

*Redacted for Privacy*

Abstract approved: \_\_\_\_\_ 1/19/70

The thermal decomposition of aralkyl thiocarbonates to carbon dioxide and the corresponding sulfide has been shown to proceed via a mechanism involving ion pair intermediates. Information concerning ion pair return in this system may be obtained from the rates of the following processes:

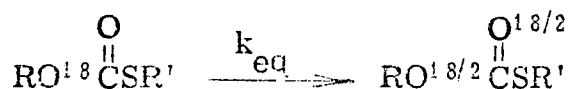
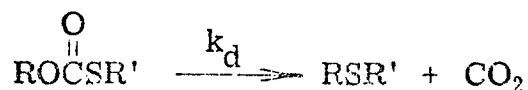

These values are given below for p-chlorobenzhydryl S-methyl ( $R' = \text{CH}_3$ ), S-cyclohexyl ( $R' = \text{C}_6\text{H}_{11}$ ) and S-phenyl ( $R' = \text{C}_6\text{H}_5$ ) thiocarbonates in benzonitrile and bromobenzene. By suitable manipulation, these values may be expressed in terms of the rate constants

<u>R'</u>	<u>T(°C)</u>	<u>Solvent</u>	$k_d \times 10^5$ (sec <sup>-1</sup> )	$k_{rac} \times 10^5$ (sec <sup>-1</sup> )	$k_{eq} \times 10^5$ (sec <sup>-1</sup> )
CH <sub>3</sub>	145	Benzonitrile	0.65	2.6	5.1
C <sub>6</sub> H <sub>11</sub>	145	Benzonitrile	0.19	0.81	1.65
C <sub>6</sub> H <sub>5</sub>	145	Benzonitrile	21.7	28.3	75.2
CH <sub>3</sub>	155	Bromobenzene	0.30		4.4
C <sub>6</sub> H <sub>5</sub>	145	Bromobenzene	1.0		8.3

in equation 1. The results of these calculations for the decomposition

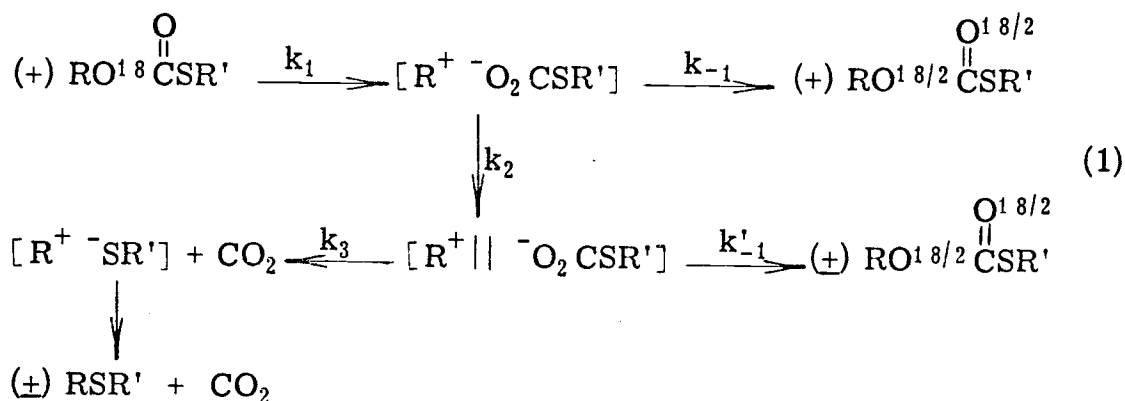

in benzonitrile at 145° are:

<u>R'</u>	$k_3 / k'_{-1}$	$k_2 / k_{-1}$
CH <sub>3</sub>	0.33	0.85
C <sub>6</sub> H <sub>11</sub>	0.27	1.00
C <sub>6</sub> H <sub>5</sub>	3.5	0.38

The large increase in  $k_3 / k'_{-1}$  in going from the S-methyl to the S-phenyl thiocarbonate is undoubtedly due to the greater stability of C<sub>6</sub>H<sub>5</sub>S<sup>-</sup> compared to CH<sub>3</sub>S<sup>-</sup>. The unexpected decrease in  $k_2 / k_{-1}$

was at first attributed to the increased steric bulk of the phenyl group causing racemization ( $k_2$ ) to be slower. However, the results with the S-cyclohexyl thiocarbonate show this to be incorrect.

Two explanations which are consistent with all the experimental evidence can be proposed. (1) In the ion pair in the S-phenyl case there is a  $\pi$ -complex type interaction between the phenyl ring on  $C_6H_5S^-$  and an aryl group of the carbonium ion which hinders the racemization process ( $k_2$  is smaller). (2) In the initial ion pair in eq. 1 the two oxygens of the carboxylate ion are not completely equivalent. Therefore  $k_{eq}$  is not a true measure of  $k_{-1}$  and gives an apparent value of  $k_{-1}$  which is appreciably lower than the real value. If this effect is more important for the S-methyl and S-cyclohexyl esters than for the S-phenyl ester this could also lead to a variation of  $k_2 / k_{-1}$  with ester structure of the type observed.

Supporting evidence for the above explanations and the significance of the results in bromobenzene are also discussed.

Ion Pair Return Phenomena in the Thermal Decomposition  
of Aralkyl Thiocarbonates

by

Roger Louis Scriven

A THESIS

submitted to

Oregon State University

in partial fulfillment of  
the requirements for the  
degree of

Doctor of Philosophy

June 1970

APPROVED:

*Redacted for Privacy*

---

Professor of Chemistry in charge of major

*Redacted for Privacy*

---

Head of Department of Chemistry

*Redacted for Privacy*

---

Dean of Graduate School

Date Thesis is presented December 18, 1969

Typed by Karen Conley for Roger Louis Scriven

## ACKNOWLEDGMENT

The author deeply appreciates the guidance and encouragement given by Professor J. L. Kice. Special recognition is due to my parents, wife and family for their patience and understanding during the completion of this work.

The author also gratefully acknowledges the use of the mass spectrometer provided by Dr. T. Koenig.

To Renee'

## TABLE OF CONTENTS

I. Introduction.....	1
Historical Background.....	1
Purpose of the Study.....	15
II. Results .....	16
Preparation of Thiocarbonates.....	16
Kinetic Studies in Benzonitrile.....	17
Determination of Rates of Decomposition.....	17
Determination of Rates of Loss of Optical Activity...	21
Determination of Rates of Equilibration.....	22
Kinetic Studies in Bromobenzene.....	23
Determination of Rates of Decomposition.....	23
Determination of Rates of Equilibration.....	26
III. Discussion.....	28
Methods of Calculating Ion Pair Return.....	28
Ion Pair Behavior in Benzonitrile.....	33
Ion Pair Behavior in Bromobenzene.....	44
IV. Summary.....	48
V. Experimental.....	50
<u>p</u> -Chlorobenzhydryl S-Methyl Thiocarbonate.....	50
<u>p</u> -Chlorobenzhydrol-O <sup>18</sup> .....	50
<u>p</u> -Chlorobenzhydrol S-Methyl Alkyl-O <sup>18</sup> Thiocarbonate..	51
<u>p</u> -Chlorobenzhydryl S-Cyclohexyl Thiocarbonate.....	52



(+) <u>p</u> -Chlorobenzhydryl S-Cyclohexyl Thiocarbonate.....	52
Alkyl-O <sup>18</sup> <u>p</u> -Chlorobenzhydryl S-Cyclohexyl Thio- carbonate.....	52
<u>p</u> -Chlorobenzhydryl S-Phenyl Thiocarbonate.....	53
(+) <u>p</u> -Chlorobenzhydryl S-Phenyl Thiocarbonate.....	53
Alkyl-O <sup>18</sup> <u>p</u> -Chlorobenzhydryl S-Phenyl Thiocarbonate..	54
(+) <u>p</u> -Chlorobenzhydryl Hydrogen Phthalate.....	54
(-) <u>p</u> -Chlorobenzhydrol.....	55
Cyclohexyl and Phenyl Chlorothioformate.....	56
Methyl Chlorothioformate.....	56
Purification of Solvents.....	57
Kinetic Studies of the Thermal Decomposition.....	57
Kinetic Studies of Equilibration.....	59
Kinetic Studies of the Loss of Optical Activity.....	63
VI. Bibliography.....	64

# ION PAIR RETURN PHENOMENA IN THE THERMAL DECOMPOSITION OF ARALKYL THIOCARBONATES

## INTRODUCTION

In the past years, there has been a considerable amount of work done concerning the nature of ion pairs in organic reactions. Although ion pairs of various inorganic salts were previously known, Winstein and coworkers were among the first to postulate ion pair type intermediates in organic reactions. While studying the rate of solvolysis of  $\alpha, \alpha$ -dimethylallyl chloride (I), Winstein and coworkers (22) found this tertiary chloride isomerized faster than it solvolyzed (equation 1). No common ion effect was observed and radioactive chloride from the solvent was only slowly exchanged. It was found that  $k_i = 2k_T = 16k_p$ . The fact that isomerization ( $k_i$ ) occurs faster

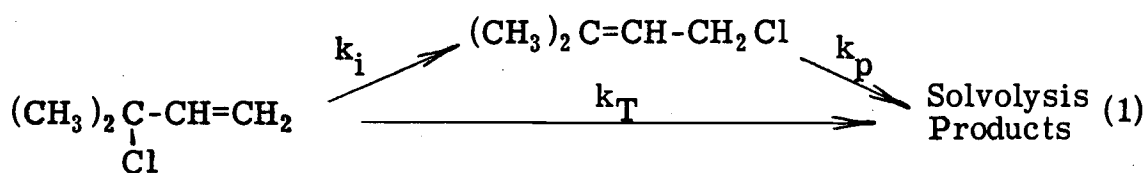

I

than solvolysis ( $k_T$ ) was best explained by assuming the formation of an ionic intermediate in which internal return (i.e. return to the halide) occurs faster than external return (i.e. return influenced by common or "external" ions) or solvolysis (equation 2).

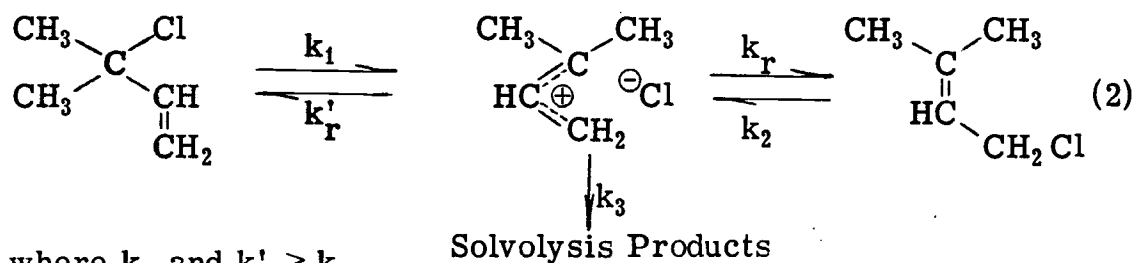

where  $k_R$  and  $k'_R > k_3$ .

Winstein and Robinson (21) observed an unexpected salt effect in the solvolysis of threo-3-p-anisyl-2-butyl tosylate. The rate loss of optical activity,  $k_\alpha$ , compared to the titrimetric solvolysis rate,  $k_t$ , was used as an indication of the ion pair return accompanying solvolysis. Upon addition of lithium perchlorate, a normal linear pattern of  $k$  versus concentration of salt was observed for  $k_\alpha$  but  $k_t$  showed a rapidly changing slope. As shown in Figure 1, there is a combination of a steep special effect and the normal linear pattern.

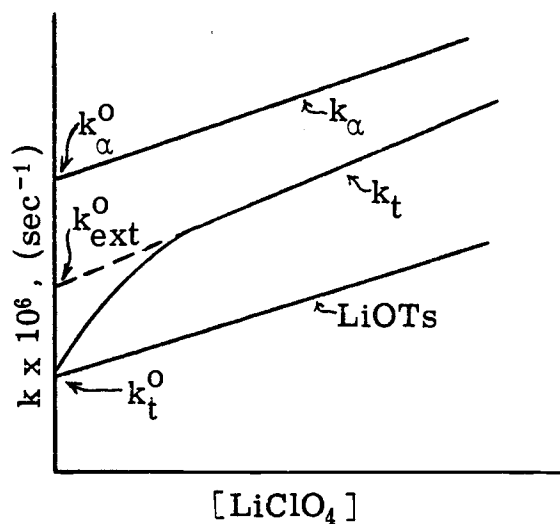
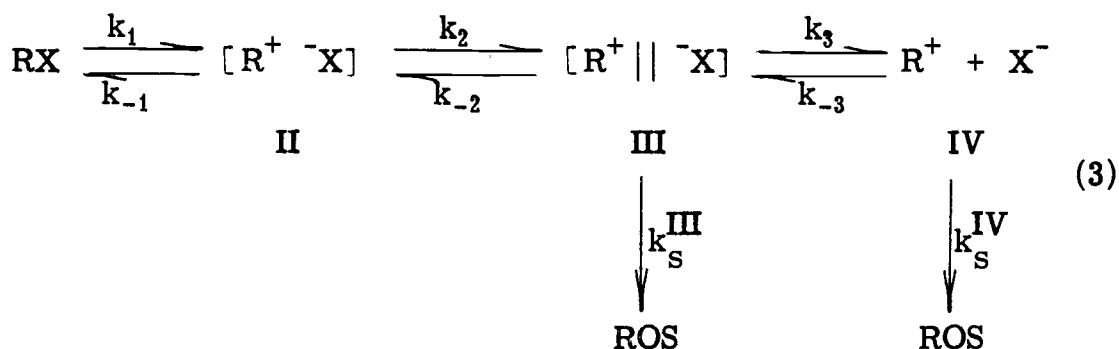

FIGURE 1.

Extrapolation of the linear portion of  $k_t$  to zero concentration of lithium perchlorate,  $k_{\text{ext}}^0$ , does not coincide with  $k_\alpha^0$ . Winstein had previously shown (20) that special salt effects are concerned with ion pair return and not with initial ionization. It was noted that the special salt effect only partly eliminates ion pair return. The large dependence of rate constants on the solvent ionizing power

showed that an ionic intermediate was responsible for racemization rather than a cyclic process. Hence,  $k_{\alpha}$  represented the ionization rate constant  $k_1$  in equation 3. The difference in  $k_{\alpha}^0$  and  $k_{\text{ext}}^0$  was attributed to the presence of two types of ion pairs, intimate (II) and solvent separated (III), which respond differently to lithium perchlorate. The ion pairs II and III are to be differentiated from the dissociated ions, IV, which are subject to mass law effect. Any solvolysis of II is neglected since the anion should effectively shield



any attack by the solvent in this case. The exact cause of the special salt effect is not known. It is observed only for lithium perchlorate (e.g. lithium tosylate gives a linear pattern with an intercept corresponding to  $k_t^0$ ). It is believed the lithium perchlorate reacts much more rapidly with the solvent separated ion pair than the intimate ion pair, thereby trapping III while allowing internal return from II. On this basis it was possible to calculate ion pair return occurring from II and III. The 3-phenyl-2-butyl system shows no special salt effect but  $k_{\alpha}$  and  $k_t$  indicate the same amount of ion pair return as with the 3-p-anisyl-2-butyl system. The major effect of the p-methoxy group seems to be an increase in

the internal return from III. This apparently arises from the increased stability of the carbonium ion formed.

At the same time that Winstein postulated two types of ion pairs in the previous example, Grunwald (8) had calculated the potential energy of ion pairs in a solvent with a moderate dielectric constant (ca. > 10). His calculations showed two distinct minima in a plot of potential energy versus distance between the ions (Figure 2). These results are in complete agreement with Winstein's work.

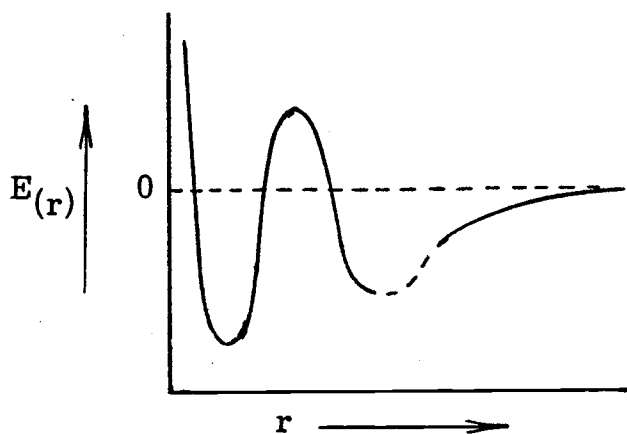
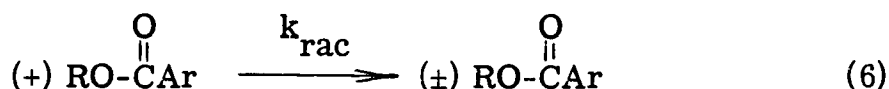
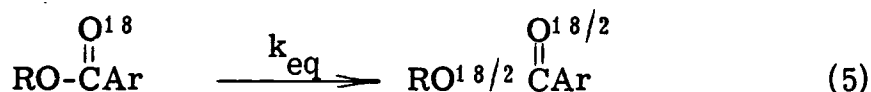

FIGURE 2.

The use of the rate of racemization as an indication of the initial ionization rate may not always be accurate since return with preservation of configuration is not detected. In an attempt to avoid this difficulty, Goering (5) found that ion pair return associated with the solvolysis (alkyl-oxygen cleavage) of  $O^{18}$  labeled benzhydryl p-nitrobenzoate ( $\underline{p}$ - $O_2NC_6H_4\overset{O^{18}}{C}OCH(C_6H_5)_2$ ) resulted in equilibration of the carbonyl and alkyl oxygens in the unsolvolyzed ester. The rate of equilibration,  $k_{eq}$ , was three times faster than the rate

of solvolysis,  $k_s$ . Assuming the carboxyl oxygens are equivalent in the ion pair intermediate,  $k_{eq}$  is a measure of reformation of ester by ion pair return.

Goering and coworkers (4) also studied the solvolysis of both optically active and  $O^{18}$ -labeled p-chlorobenzhydryl p-nitrobenzoate in aqueous acetone (80 and 90 percent). Equilibration of the carboxyl oxygens (equation 5) and racemization of the unsolvolyzed ester (equation 6) occurred during solvolysis (equation 4). Assuming



equation 5 is indicative of total ion pair return, and equation 6 indicates return with racemization, the stereochemistry of ion pair return is obtained from the relative values of  $k_{eq}$  and  $k_{rac}$ . Since  $k_{eq}$  is greater than  $k_{rac}$ , much of the return from ion pairs occurs with retention of configuration. For example, in 90 percent acetone, of the 72 percent of ion pair intermediates returning to ester, 81 percent return with retention of configuration and 19 percent return with racemization. The percentage of ion pairs returning to ester decreases to 60 percent in 80 percent acetone. The amount returning with retention of configuration is 57 percent and return with racemization is 43 percent. Apparently, the better ionizing solvent

(80 percent acetone) facilitates dissociation and solvolysis of the ion pairs.

The effect of nucleophiles (6) on ion pair return was used to provide evidence as to whether one or two ion pairs are involved. It was found that in the solvolysis of (-) *p*-chlorobenzhydryl *p*-nitrobenzoate in the presence of 0.014 M sodium azide, the unsolvolyzed  $O^{18}$  equilibrated ester recovered had exclusively retained configuration. In other words, under these conditions all return from the ion pair occurred with complete retention of configuration (ie.,  $k_{rac} \cong 0$ ). This was interpreted to mean that there are two types of ion pairs present, as postulated by Winstein (21), and that the azide ion, by trapping the carbonium ion in the solvent separated ion pair, is preventing return from that species, but that azide is not able to prevent return from the intimate ion pair.

Other methods for measuring ion pair return have also been used. Smith (15) found isomerization of benzhydryl thionbenzoate (V) to benzhydryl thiobenzoate (VI) was faster than solvolysis of

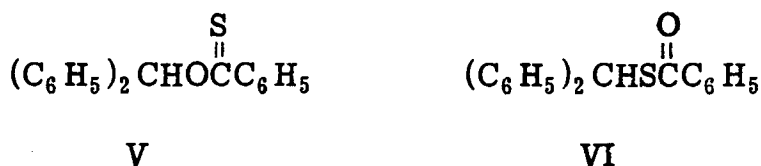

the thionbenzoate ester. Since a carbonium ion intermediate is clearly involved in the rearrangement ( $\rho$  for  $\text{C}_6\text{H}_5\overset{\text{Ar}}{\text{C}}\overset{\text{S}}{\text{O}}\text{CC}_6\text{H}_5 = -3.6$ ), it was assumed ionization resulted in the formation of an ion pair. There is a strong tendency for isomerization of V to the thiol ester VI. This presumably arises from the sulfur portion of the

anion being a much better nucleophile than the oxygen portion and the fact that thiol esters are much more thermodynamically stable than the thion esters. Hence, the rate of appearance of thiol ester gives a sensitive method for detecting ionization and ion pair return.

Fava (3) also made use of an ambident anion in studying ion pair return phenomena. The nature of the ionic intermediate in the isomerization of 4,4'-dimethylbenzhydryl thiocyanate (VII) to the isothiocyanate (VIII) was investigated using  $\text{NaS}^{35}\text{CN}$  to determine

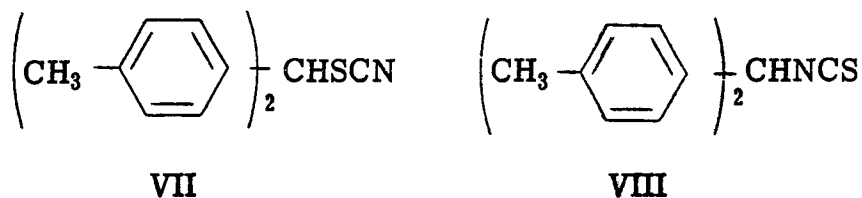

the amount of external exchange. It was found that only a small amount of radioactive label is taken up in the isomerization process. It was concluded that isomerization occurs via an intimate ion pair and that further dissociation is needed for exchange with  $\text{S}^{35}\text{CN}^-$  to occur. The ratio of the rate of isomerization to the rate of exchange provided an upper limit to the fraction of intimate ion pairs dissociating (5.4 percent). Thus at least 95 percent of the ion pairs formed returned to the covalent state. By measuring the ratio of the number of labeled thiocyanate atoms to the number of labeled isothiocyanate atoms in partially isomerized material and extrapolating to zero time, it was found that formation of thiocyanate is favored by five to one over formation of isothiocyanate.



The use of ambident ions as an indication of ion pair return has one obvious disadvantage in that the "teeth" of the ion are not equivalent as they were in the case of Goering's carboxylate anion systems. Hence, one does not have an equal partitioning of return pathways. The partitioning of the ambident ion may also be dependent upon temperature and solvent whereas at first glance, it would appear that the carboxylate ion must always partition exactly equally between return to  $\text{RO}^{18}\overset{\text{O}}{\parallel}\text{C}\text{Ar}$  and  $\text{RO}\overset{\text{O}^{18}}{\parallel}\text{C}\text{Ar}$ . However, there is some experimental evidence which may indicate that the oxygens do not always become equivalent in Goering's carboxylate anion systems.

Diaz and Winstein (1) have studied the reaction between diphenyldiazomethane (IX) and molecular benzoic acid in ethanol (equation 7). The behavior of benzhydryl benzoate ion pairs (X)

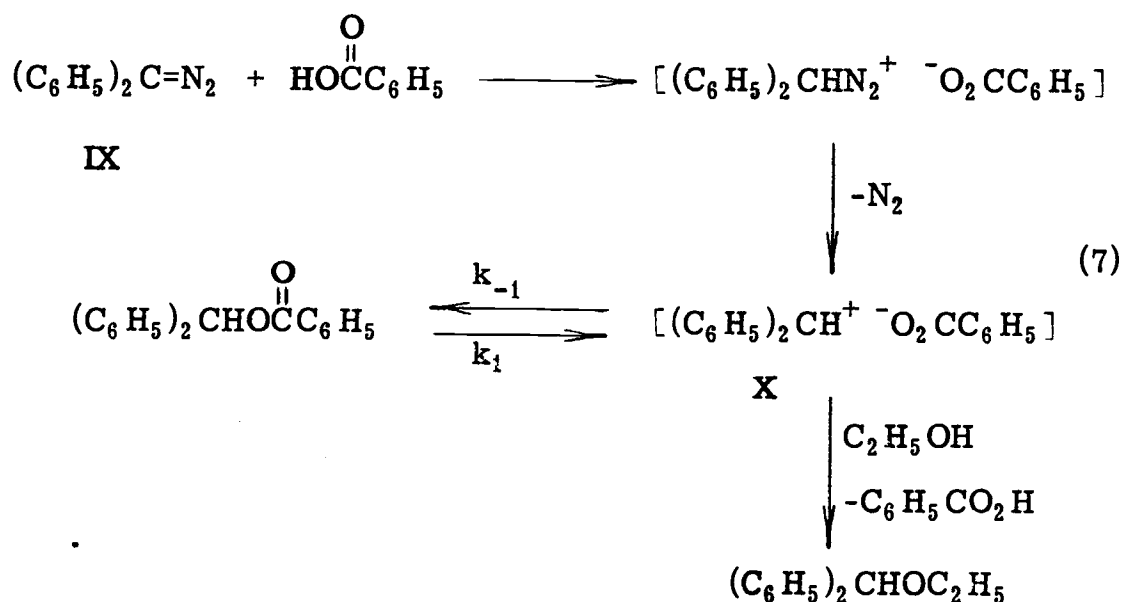

arising from loss of nitrogen was compared with their counterparts in the solvolysis of benzhydryl benzoate. Using  $\text{O}^{18}$ -labeled

benzoate to indicate ion pair return in the solvolysis and appearance of ester as an indication of ion pair return in equation 7, it was found that a larger fraction of ion pair return occurred in the diphenyldiazomethane reaction than in the corresponding solvolysis (0.558 and 0.47 respectively). Similar results were also observed for the p-nitrobenzoate system in 90 percent acetone (0.822 and 0.745 respectively). Since the ion pairs involved are the same in both cases, it was believed that the smaller value for return in solvolysis was due to partial nonequivalence of the oxygens in the carboxylate anion. This conclusion is supported by White and Elliger (18) in their study of the decomposition of a nitrosoamide of benzhydrylamine in ethanol (equation 8). In this case, the O<sup>18</sup>-labeled nitrosoamide (XI) yielded products with 60 percent of the

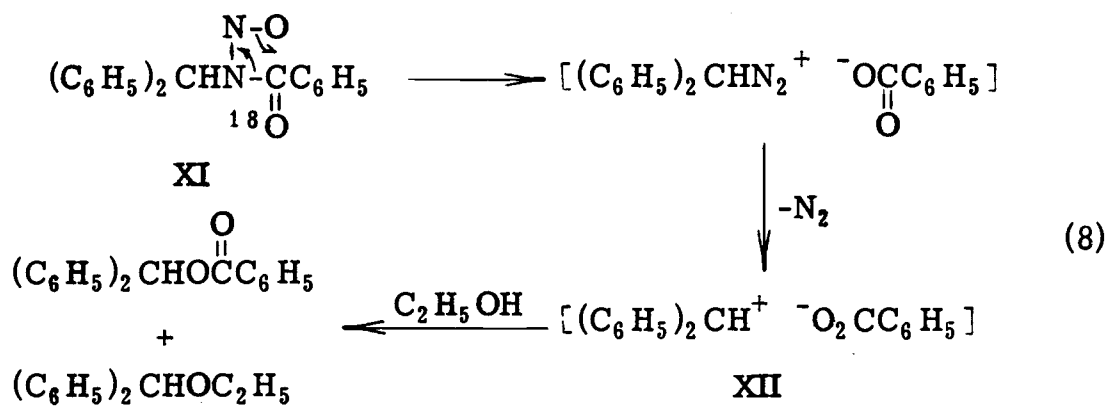

label in the carbonyl position. Assuming the same types of ion pairs are involved as in the other cases, these results indicate that a minimum of 20 percent of the ion pairs in the solvolysis reaction return without the oxygens being equilibrated.

Ion pairs are also believed to be present in the thermal decomposition of compounds of the type  $\text{RO}\overset{\text{O}}{\parallel}\text{CY}$  (where  $\text{Y} = \text{Cl}$ ,  $\overset{\text{O}}{\parallel}\text{CCl}$ , etc.). The thermal decomposition of chlorocarbonates ( $\text{Y} = \text{Cl}$ ) was studied by Wiberg (19) and Young (13). Wiberg used various substituted  $\alpha$ -phenethyl chlorocarbonates (XIII) which were converted

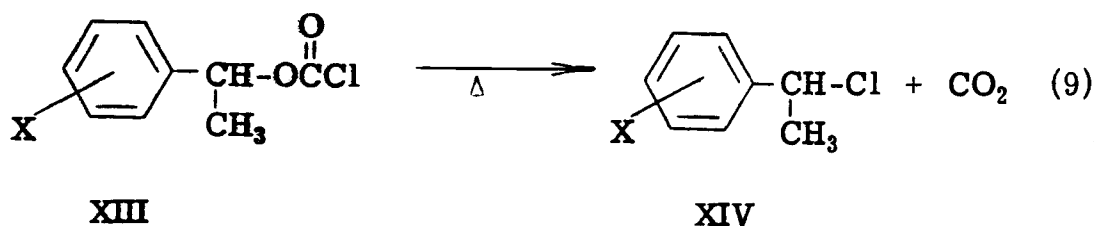

upon heating to the corresponding chloride (XIV) with loss of carbon dioxide (equation 9). A Hammett plot (9) of  $\log k$  versus  $\sigma$  for X had a large negative slope, which is indicative of a carbonium ion intermediate being formed in the reaction. Optically active  $\alpha$ -phenethyl chlorocarbonate gave a high degree of retention of configuration in the corresponding chloride in a moderately polar solvent (dioxane). Presumably, the loss of carbon dioxide occurs from some type of ion pair rather than from dissociated ions. Otherwise, one would be unable to account for the high degree of retention of configuration. Unfortunately, the authors did not conduct any experiments which would give any information concerning total ion pair return compared to return with retention of configuration.

Young (13) studied the thermal decomposition of butenyl chlorocarbonates in greater detail. The large dependence of the decomposition rate upon solvent ionizing power indicated the rate-

determining step was an ionization process (16). Optically active  $\alpha$ -methylallyl chlorocarbonate ( $\text{CH}_2=\text{CH}-\overset{\text{CH}_3}{\underset{\text{CH}_3}{\text{C}}}-\overset{\text{O}}{\parallel}{\text{C}}\text{OCl}$ ) gave the corresponding chloride ( $\text{CH}_2=\text{CH}-\overset{\text{CH}_3}{\underset{\text{CH}_3}{\text{C}}}\text{HCl}$ ) with varying degrees of retention of configuration depending upon the solvent used. These results were explained by a mechanism in which dissociation of the ion pair formed occurred after loss of carbon dioxide. Data was not available for quantitative calculation of ion pair return.

Rhoades and Michel (14) studied the decomposition of alkyl chloroglyoxalates (XV) which are structurally analogous to alkyl chlorocarbonates. Upon heating, decomposition of  $\alpha$ -phenethyl

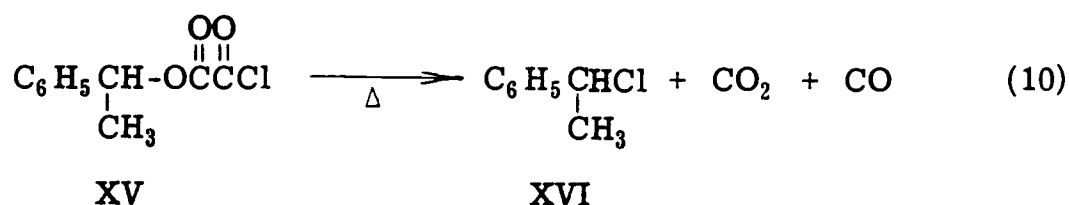

chloroglyoxalate (XV) to the corresponding chloride (XVI) occurs with loss of carbon dioxide and carbon monoxide (equation 10). Two mechanistic extremes were proposed by which the reaction might proceed (equation 11). In mechanism A, a cyclic transition state

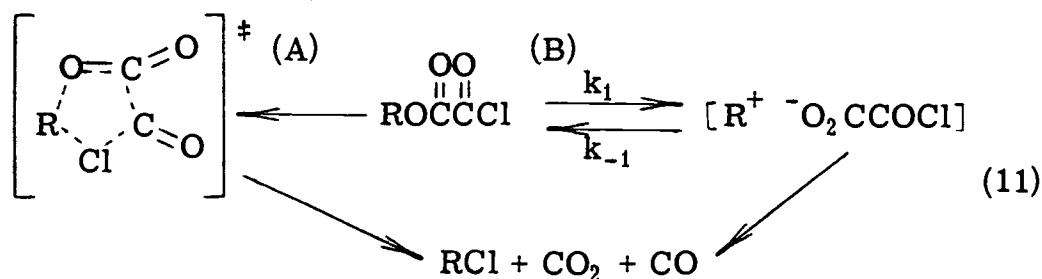

occurs, to give loss of carbon dioxide and carbon monoxide concurrent with breakage of the R-O bond. Mechanism B is an ionic pathway in which an intermediate ion pair is formed by scission of the R-O bond followed by loss of carbon monoxide and carbon dioxide. A rate of decomposition ratio of ca. 14:1 was observed for the solvents nitrobenzene and toluene. Oliver and Young (13) had observed a rate ratio of ca. 100:1 for the same solvents in the decomposition of chlorocarbonates. Apparently, the decomposition of the chloroglyoxalates is less sensitive to solvent ionizing power than the chlorocarbonate decomposition, and because of this and the results about to be discussed, Rhoades and Michel favored mechanism A or some somewhat more polar version of it.

The alkyl chloroglyoxalates were originally expected to be less stable than the corresponding chlorocarbonates. This prediction was based on the idea of the rate-determining step involving only the scission of the alkyl-oxygen bond (mechanism B) and the fact that  $\text{O}_2\text{CCl}^-$  should be a less stable anion than  $\text{O}_2\text{CCOCl}^-$  (ie.  $K_{a_{\text{HCOOH}}} = 18 \times 10^{-5}$  and  $K_{a_{\text{HCOCOHOH}}} = 47 \times 10^{-5}$ , therefore  $\text{O}_2\text{CCOCl}^-$  is more stable than  $\text{O}_2\text{CCl}^-$ ). Since the alkyl chloroglyoxalates actually turn out to be more stable ( $\alpha$ -phenethyl chlorocarbonate decomposes ca. 1000 fold faster than  $\alpha$ -phenethyl chloroglyoxalate under similar conditions), more than just cleavage of the R-O bond must be involved in the rate-determining step. Work by Kice and Parham (12) in which the rate of thermal decomposition

of thiosulfonates (XVII) was shown to be dependent upon both R and R' suggested that two bonds (R-SO<sub>2</sub>-SR') are being broken in the

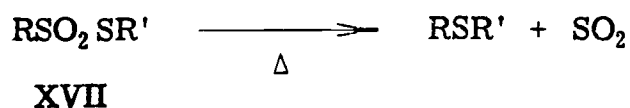

rate-determining step of that reaction. Rhoades and Michel therefore postulated that the carbon-chlorine bond as well as the carbon-oxygen bond is being broken in the rate-determining step of chloroglyoxate decomposition. This, and the moderate dependence of rate on solvent ionizing power led them to favor the cyclic mechanism, (B).

Thermal decompositions of ROCOY compounds may be studied in greater detail by use of a ROCOZR' system which loses carbon dioxide to form RXR'. This has the advantage of allowing investigation of the effect of R' on the rate of decomposition. Kice and coworkers (10) have shown that thiocarbonates (XVIII) lose carbon dioxide to form the corresponding sulfide (XIX) upon being heated at elevated temperatures (equation 12). The decomposition

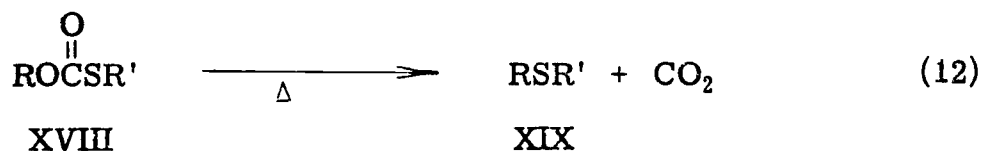

of the thiocarbonates is analogous to the chlorocarbonates in that it exhibits the same dependence of rate on solvent ionizing power and structure of the R group. Several benzhydryl thiocarbonates were

studied to evaluate the effect of R' on the rate of decomposition. The dependence of rate on R' was such as to indicate that the  $\overset{\text{O}}{\parallel}\text{C-S}$  bond was being broken in the rate-determining step. Two mechanisms consistent with this fact and with the other data on the dependence of rate on both structure of R and solvent can be proposed:

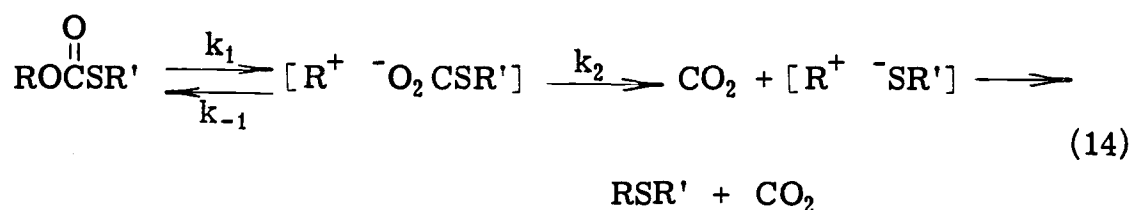
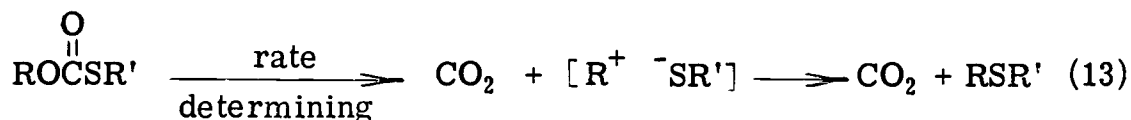

In one mechanism (equation 13), heterolysis of the carbon-sulfur bond is synchronous with the scission of the alkyl-oxygen bond. The other mechanism (equation 14) has the alkyl-oxygen bond breaking first, followed by cleavage of the carbon-sulfur bond in the rate-determining step (ie.  $k_{-1} > k_2$ ).

Kice and Dankleff (11) were later able to show that the mechanism in equation 14 is apparently the correct one. They did this by studying the stereochemistry of the decomposition. Using optically active *p*-chlorobenzhydryl *S*-methyl thiocarbonate, the rate of racemization of the optically active ester was found to be four times faster than its rate of decomposition to sulfide and carbon dioxide. The mechanism which has two separate bond breaking steps (equation 14) readily accommodates this observation. With

$k_2 < k_{-1}$ , return to covalency from the first ion pair will lead to racemization of much of the thiocarbonate prior to its decomposition. On the other hand, the mechanism shown in equation 13 cannot explain the occurrence of racemization of the thiocarbonate preceding its decomposition. These results, then, provide strong evidence for a mechanism in which an initial alkyl-oxygen bond heterolysis is followed by rate-determining cleavage of the  $\overset{\text{O}}{\parallel}{\text{C}}-\text{S}$  bond in the  $\text{R}'\text{SCO}_2^-$  anion.

The purpose of this thesis was to investigate the return phenomena of the ion pairs involved in the thermal decomposition of aralkyl thiocarbonates in much more detail. Specifically, it was hoped that this study would provide both valuable insight into the detailed mechanism of  $\text{S}_{\text{N}}\text{i}$  reactions of the type shown in equation 15

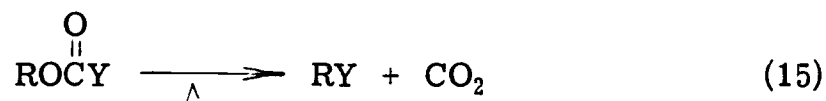

and also increase our general knowledge of ion pair return phenomena by investigating them under conditions somewhat different than those used by Goering, Fava, Winstein and other previous workers in this field.



## RESULTS

Preparation of Thiocarbonates. The various p-chlorobenzhydryl thiocarbonates were all prepared by reaction of p-chlorobenzhydryl with the appropriate chlorothioformate in a benzene solution containing an equivalent amount of pyridine (equation 16). In the case of

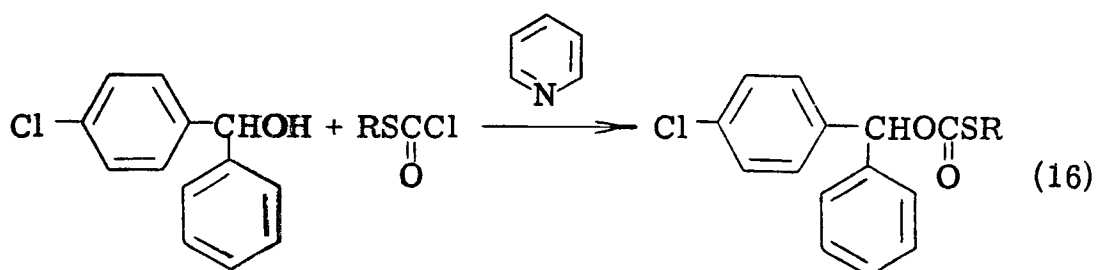

optically active and  $\text{O}^{18}$ -labeled thiocarbonate, (-) p-chlorobenzhydryl and p-chlorobenzhydryl- $\text{O}^{18}$  were used, respectively.

In general, yields were not high and the thiocarbonates usually had to be purified by column chromatography.

Kice and coworkers (10) have previously studied the products of decomposition of benzhydryl S-phenyl thiocarbonate in benzonitrile and bromobenzene and found the major products consisted of carbon dioxide (100% yield) and benzhydryl phenyl sulfide (78-83% yield). A small amount of phenyl disulfide (ca. 2%) was also detected. Hence, the thermal decomposition proceeds primarily according to equation 17.



Kinetic Studies of the Decomposition of S-Methyl, S-Cyclohexyl, and S-Phenyl p-Chlorobenzhydryl Thiocarbonate in Benzonitrile.

The kinetics of the decomposition reactions were followed by following the disappearance of the carbonyl group absorption due to the  $\text{>C=O}$  group of the thiocarbonate in an infrared spectrophotometer. Kice and coworkers (10) had previously shown that the intensity of the carbonyl group absorption follows the Lambert-Beer law. The decompositions of S-methyl (XX), S-cyclohexyl (XXIII), and S-phenyl (XXVI) p-chlorobenzhydryl thiocarbonates all showed reasonably good first order kinetics when followed in this way. Thus, a plot of  $\log A$  versus time gave a straight line over about 60-70 percent of the reaction (see Figures 3-5).

Table 1 lists the kinetic data for the decomposition of XX, XXIII, and XXVI in benzonitrile.

TABLE 1. Kinetics of Decomposition of p-Chlorobenzhydryl Thiocarbonates in Benzonitrile at  $145^\circ$ .  $\text{p-ClC}_6\text{H}_4\text{CHOCSR}$   
 $\text{C}_6\text{H}_5 \quad \text{O}$

R	Conc., (M)	$t_{1/2} \times 10^{-4}$ (sec)	$k_d \times 10^5$ (sec $^{-1}$ )	$r^a$
CH <sub>3</sub>	0.083	10.7	0.645	0.9982
	0.086	10.6	0.649	0.9991
C <sub>6</sub> H <sub>11</sub>	0.089	35.0	0.197	0.9970
	0.10	36.7	0.188	0.9979
C <sub>6</sub> H <sub>5</sub>	0.095	3.24	21.3	0.9996
	0.095	3.06	22.5	0.9991
	0.097	3.42	20.2	0.9992

<sup>a</sup>Correlation coefficient.

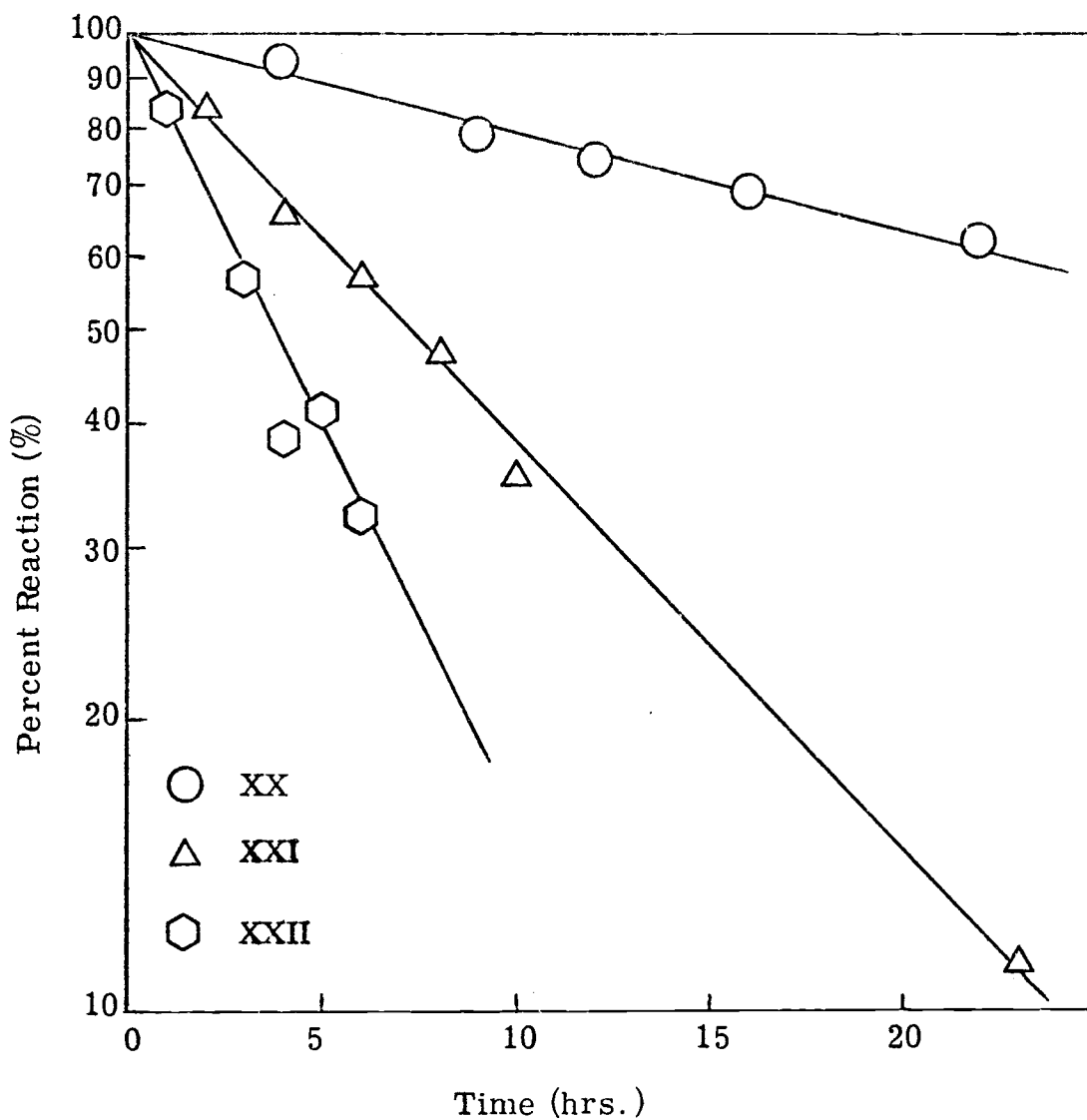

FIGURE 3. Log of Percent Thiocarbonate Undecomposed versus Time for S-Methyl, (+) S-Methyl, and Alkyl-O<sup>18</sup> S-Methyl *p*-Chlorobenzhydryl Thiocarbonate in Benzonitrile at 145°.

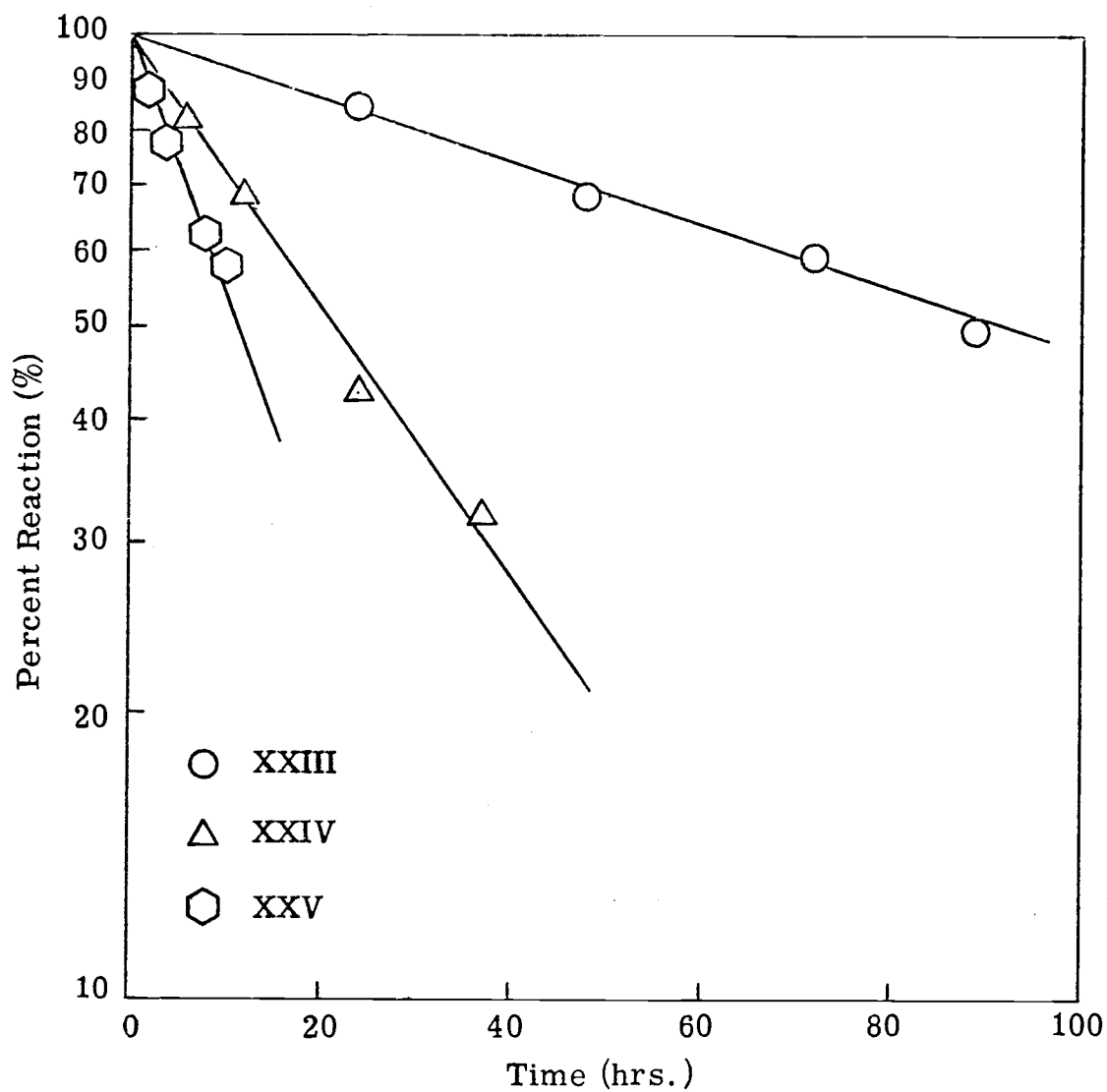

FIGURE 4. Log of Percent Thiocarbonate Undecomposed versus Time for S-Cyclohexyl, (+) S-Cyclohexyl and Alkyl-O<sup>18</sup> S-Cyclohexyl p-Chlorobenzhydryl Thiocarbonate in Benzonitrile at 145°.

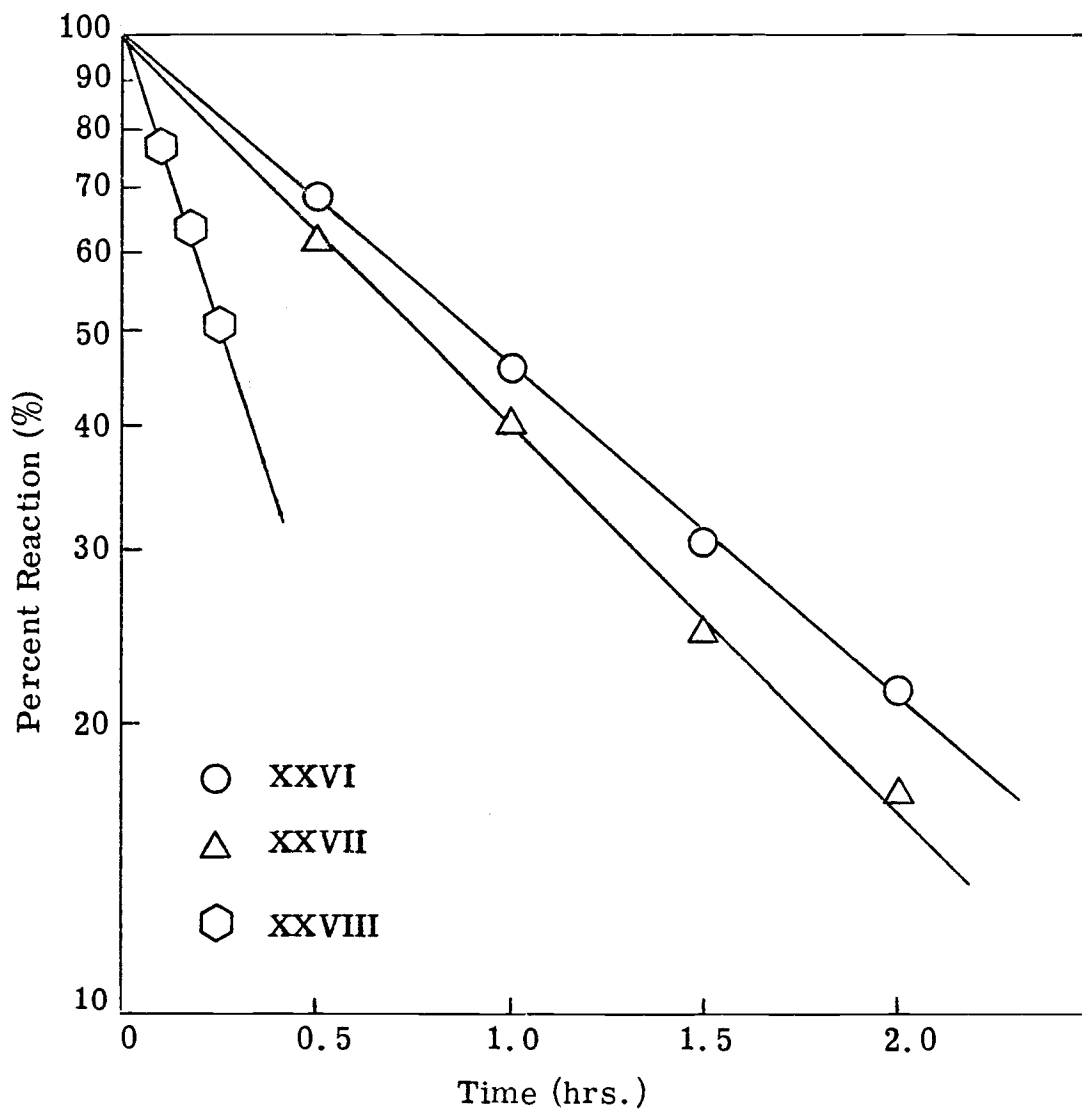

FIGURE 5. Log of Percent Thiocarbonate Undecomposed versus Time for S-Phenyl, (+) S-Phenyl, and Alkyl-O<sup>18</sup> S-Phenyl p-Chlorobenzhydryl Thiocarbonate in Benzonitrile at 145°.

Kinetics of Racemization of (+) S-Methyl, (+) S-Cyclohexyl, and (+) S-Phenyl *p*-Chlorobenzhydryl Thiocarbonate in Benzonitrile. The rate of racemization accompanying the decomposition of thiocarbonates was measured by following the loss of optical activity of the thiocarbonate solution with a polarimeter. Since the decomposition products are totally racemic, the loss of optical activity, or polarimetric rate,  $k_{\alpha}$ , is related to the rate of racemization,  $k_{\text{rac}}$ , as shown in equation 18.

$$k_{\alpha} = k_{\text{rac}} + k_{\text{d}} \quad (18)$$

where  $k_{\text{d}}$  is the rate of decomposition.

Plots of the logarithm of the observed rotation at 400  $m\mu$  versus time for (+) S-methyl (XXI), (+) S-cyclohexyl (XXIV), and (+) S-phenyl (XXVII) *p*-chlorobenzhydryl thiocarbonates are shown in Figures 3-5. These plots are all nicely linear. From their slopes, the values of  $k_{\alpha}$  for the various thiocarbonates in benzonitrile shown in Table 2 were obtained.

TABLE 2. Kinetics of Racemization of p-Chlorobenzhydryl Thiocarbonates in Benzonitrile at 145°. (+) p-ClC<sub>6</sub>H<sub>4</sub>-CHOCSR

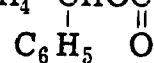

R	Conc., (M)	$t_{1/2} \times 10^{-4}$ (sec)	$k_{\alpha} \times 10^5$ (sec <sup>-1</sup> )	r
CH <sub>3</sub> <sup>a</sup>	0.341	28.0	2.46	
	0.149	25.9	2.66	
C <sub>6</sub> H <sub>11</sub>	0.099	98.5	0.70	0.9988
	0.099	74.2	0.93	0.9983
C <sub>6</sub> H <sub>5</sub>	0.095	2.63	26.2	0.9987
	0.095	2.27	30.4	0.9999

<sup>a</sup>E. Koubeck, unpublished results.

Kinetics of Oxygen Equilibration of Alkyl-O<sup>18</sup>-S-Methyl, S-Cyclohexyl, and S-Phenyl p-Chlorobenzhydryl Thiocarbonate in Benzonitrile. The rate of oxygen equilibration of the alkyl-O<sup>18</sup> labeled thiocarbonates was measured by partially decomposing samples of the thiocarbonate in benzonitrile, recovering the undecomposed ester, and then reducing it with lithium aluminum hydride. The p-chlorobenzhydryl resulting from this reduction was then analyzed for O<sup>18</sup> content. The rate constants for O<sup>18</sup> equilibration,  $k_{eq}$ , were determined by plotting the fraction of the label on the alkyl oxygen remaining versus time (Figures 3-5).

The kinetic data for the rate of equilibration of alkyl-O<sup>18</sup>-S-methyl (XXII), S-cyclohexyl (XXV), and S-phenyl (XXVIII) p-chlorobenzhydryl thiocarbonate in benzonitrile are listed in Table 3.

TABLE 3. Kinetics of Equilibration of Acyl and Alkyl Oxygens in p-Chlorobenzhydryl Thiocarbonates in Benzonitrile at 145°.

$$\text{p-ClC}_6\text{H}_4\text{-CHO} \overset{\text{R}}{\parallel} \text{CS}$$

$$\text{C}_6\text{H}_5 \quad \text{O}$$

---

R	Conc., (M)	$t_{1/2} \times 10^{-4}$ (sec)	$k_{\text{eq}} \times 10^{-5}$ (sec <sup>-1</sup> )	r
CH <sub>3</sub>	0.375	11.5	5.12	0.9979
C <sub>6</sub> H <sub>11</sub>	0.381	41.8	1.65	0.9967
C <sub>6</sub> H <sub>5</sub>	0.407	0.918	75.2	0.9997

---

Kinetics of Decomposition of S-Methyl and S-Phenyl p-Chlorobenzhydryl Thiocarbonate in Bromobenzene. The kinetics of the decomposition reaction in bromobenzene were followed in the same manner as in benzonitrile. The same apparatus (see Experimental) was used to take samples from a solution of XXVI whereas XX was run in sealed tubes due to the higher temperature used.

The reactions exhibited good first order kinetics although in some runs with XX, there was acceleration of the reaction in the later stages (Figures 6 and 7). The initial rates, however, were reproducible.

Table 4 lists the kinetic data for the decomposition of XX and XXVI in bromobenzene.



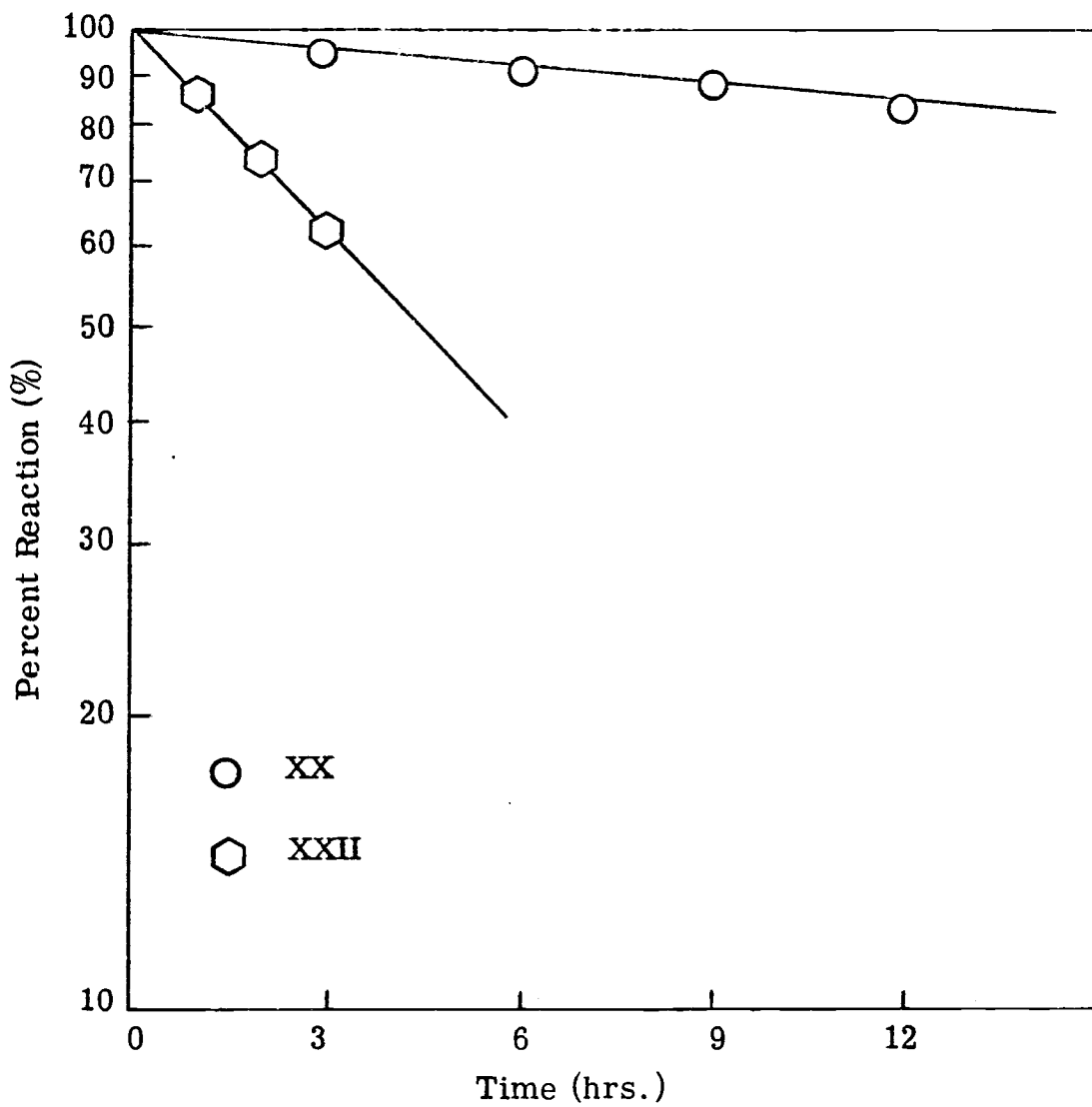

FIGURE 6. Log of Percent Thiocarbonate Undecomposed versus Time for S-Methyl and Alkyl-O<sup>18</sup> S-Methyl p-Chloro-benzhydrol Thiocarbonate in Bromobenzene at 155°.

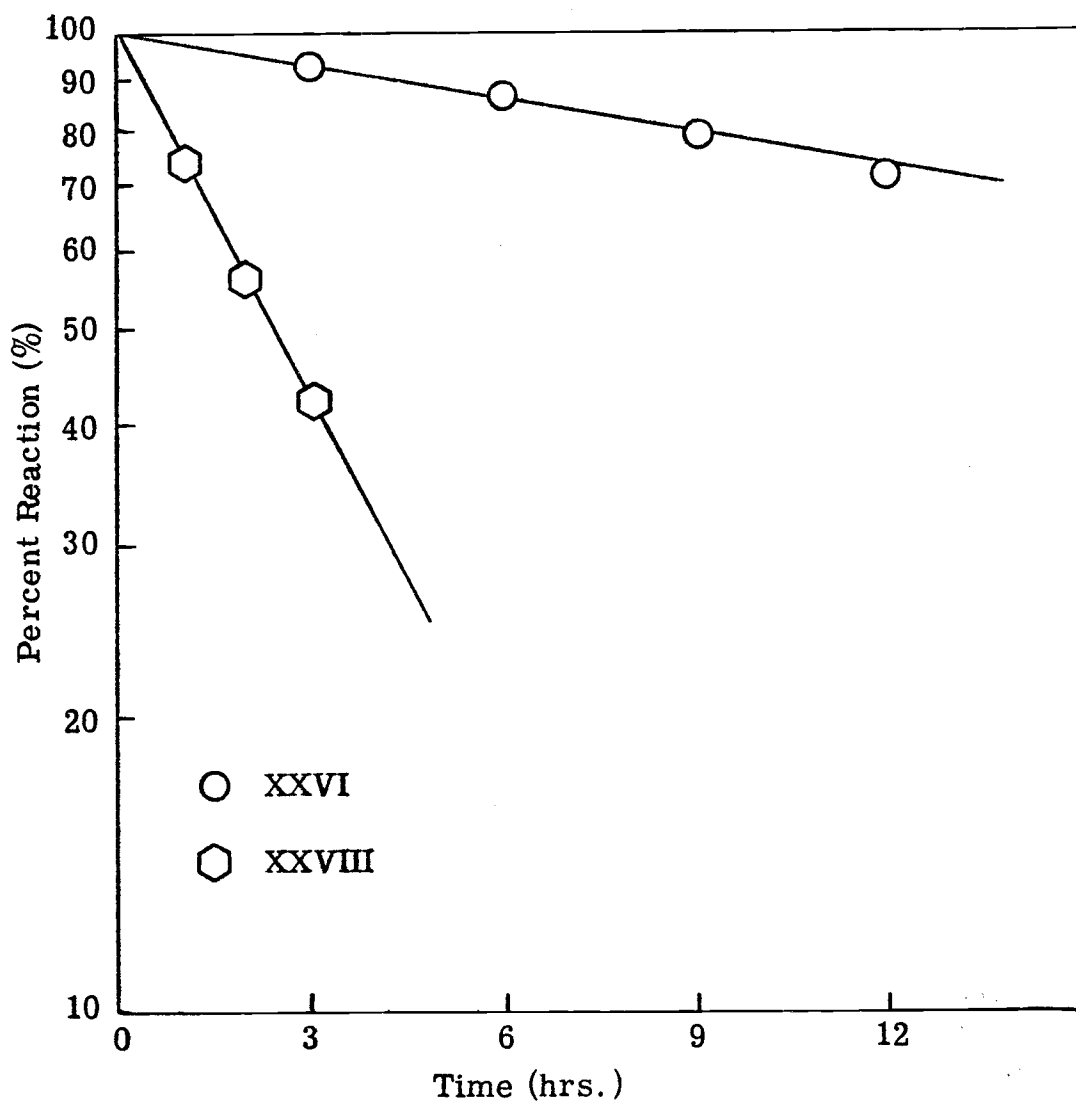

FIGURE 7. Log of Percent Thiocarbonate Undecomposed versus Time for S-Phenyl and Alkyl-O<sup>18</sup> S-Phenyl p-Chlorobenzhydryl Thiocarbonate in Bromobenzene at 145°.

TABLE 4. Kinetics of Decomposition of XX and XXVI in Bromobenzene.

R	Temp. (°C)	Conc., (M)	$k_d \times 10^5$ (sec. <sup>-1</sup> )	r
CH <sub>3</sub>	155	0.081	0.30	0.9983
		0.074	0.27	0.9657
C <sub>6</sub> H <sub>5</sub>	145	0.091	0.999	0.9948
		0.088	1.07	0.9989

Kinetics of Oxygen Equilibration of Alkyl-O<sup>18</sup>-S-Methyl and S-Phenyl p-Chlorobenzhydryl Thiocarbonate in Bromobenzene. The same method was used to determine the rates of equilibration of XXII and XXVIII in bromobenzene as in benzonitrile. However, the rates were followed only over ca. 40 percent of the reaction since the purification of the p-chlorobenzhydryl resulting from the reduction of the recovered thiocarbonate was very difficult at longer reaction times (Figures 6 and 7).

The kinetic data for the rates of equilibration of XXII and XXVIII are given in Table 5.

TABLE 5. Kinetics of Equilibration of Acyl and Alkyl Oxygens in XXII and XXVIII in Bromobenzene.

R	Temp., (°C)	Conc., (M)	$k_{eq} \times 10^5$ (sec <sup>-1</sup> )	r
CH <sub>3</sub>	155	0.346	4.36	0.9998
C <sub>6</sub> H <sub>5</sub>	145	0.305	8.26	0.9999

## DISCUSSION

It has already been shown that the thermal decomposition of aralkyl thiocarbonates proceeds through a mechanism involving the initial formation of a  $[\text{ArAr}'\text{CH}^+ \text{ } ^-\text{O}_2\text{CSR}]$  ion pair intermediate (equation 19). There are four experimental observations one can

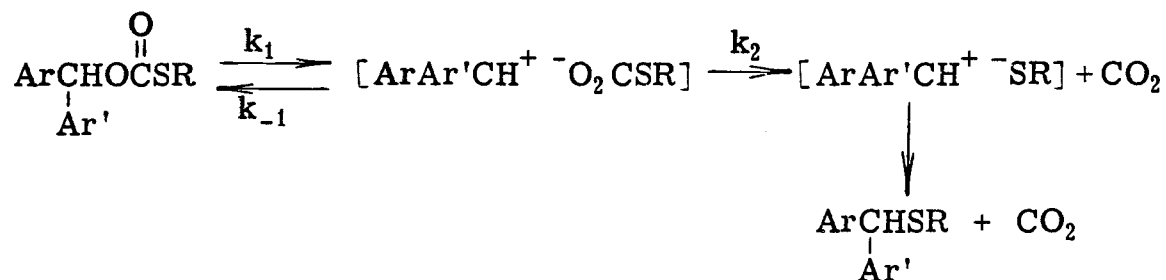

make on the system which one can use to provide information concerning the fate of these ion pairs. Thus, one can measure (1) the rate of decomposition,  $k_d$  (equation 20), (2) the rate loss of optical activity,  $k_\alpha$  (equation 21), (3) the rate of equilibration of alkyl and acyl oxygens,  $k_{eq}$  (equation 22), and (4) one can also determine the stereochemistry of the sulfide product  $\text{RSR}'$  formed in the decomposition.

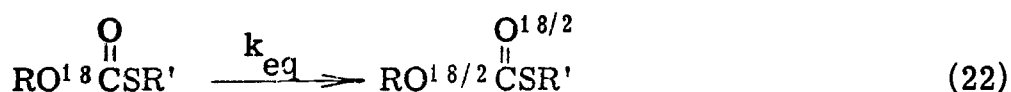
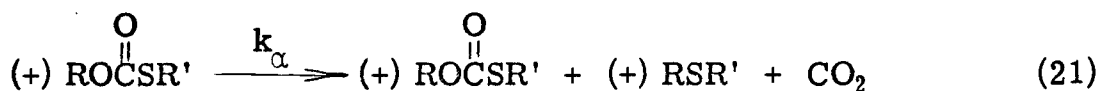
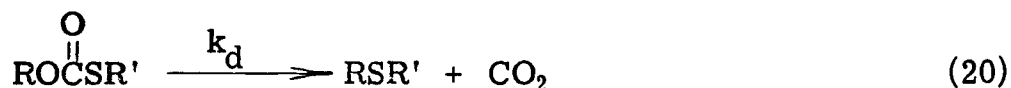

Operationally, one can consider that the ion pair intermediate XXIX (equation 23) can undergo three different detectable reactions:

(a) return to covalency with retention of configuration but scrambling of  $O^{18}$  label ( $k_a$ ); (b) return with racemization and scrambling of  $O^{18}$  label ( $k_b$ ); and (c) loss of  $CO_2$  to give ion pair  $[R^+ \text{ } ^-SR']$  ( $k_c$ ). The consideration of whether there may also be some return of **XXIX** to covalency that involves neither loss of configuration nor scrambling of  $O^{18}$  label, i.e.,  $k'_a$  in equation 23, will be deferred for the time being. Such a process cannot, of course, be detected in any way. In terms of the scheme shown in equation 23, the rate

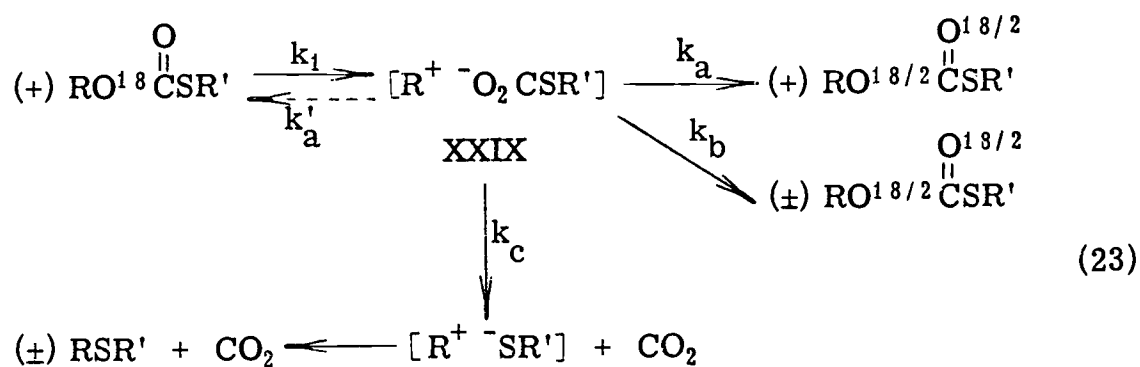

constants  $k_d$ ,  $k_\alpha$ , and  $k_{eq}$  can be expressed as shown in equation 24. Note that because all the sulfide product  $\text{RSR}'$  is racemic under our reaction conditions,  $k_\alpha$  is equal to  $k_1(k_b + k_c)/(k_a + k_b + k_c)$ . Were some of the sulfide optically active, this would not be the case.

$$\begin{aligned}
 k_d &= k_1 \left( \frac{k_c}{k_a + k_b + k_c} \right) \\
 k_\alpha &= k_1 \left( \frac{k_b + k_c}{k_a + k_b + k_c} \right) \\
 k_{eq} &= k_1 \left( \frac{k_a + k_b}{k_a + k_b + k_c} \right)
 \end{aligned} \quad (24)$$

By suitable manipulation, the ratio  $k_c/k_b$  can be expressed in terms of the experimentally measurable quantities  $k_d$  and  $k_\alpha$ , as shown in equation 25.

$$k_d/k_\alpha = \frac{k_1 \left( \frac{k_c}{k_a + k_b + k_c} \right)}{k_1 \left( \frac{k_b + k_c}{k_a + k_b + k_c} \right)} = \frac{k_c}{k_b + k_c}$$

$$k_c/k_b = \frac{k_d/k_\alpha}{1 - k_d/k_\alpha} = \frac{k_d}{k_\alpha - k_d} \quad (25)$$

In the same manner,  $k_a/k_b$  can also be expressed in terms of experimentally measurable quantities, as outlined in equation 26.

$$k_{eq}/k_\alpha = \frac{k_a + k_b}{k_b + k_c} = \frac{1 + k_a/k_b}{1 + k_c/k_b}$$

$$k_a/k_b = (k_{eq}/k_\alpha) \left[ 1 + \frac{k_d/k_\alpha}{1 - k_d/k_\alpha} \right] - 1$$

$$k_a/k_b = k_{eq}/(k_\alpha - k_d) - 1 \quad (26)$$

The fates of the ion pairs are then calculated by substituting the values of  $k_a/k_b$  and  $k_c/k_b$  obtained from equations 25 and 26 into equations 27-29. Thus, the fraction of ion pairs losing carbon dioxide, pathway c, is:

$$\frac{k_c}{k_a + k_b + k_c} = \frac{k_c/k_b}{k_a/k_b + 1 + k_c/k_b} \quad (27)$$

while the fraction of ion pairs undergoing return with racemization, pathway b, is:

$$\frac{k_b}{k_a + k_b + k_c} = \frac{1}{k_a/k_b + 1 + k_c/k_b} \quad (28)$$

and the fraction of ion pairs undergoing return with retention, pathway a, is:

$$\frac{k_a}{k_a + k_b + k_c} = \frac{k_a/k_b}{k_a/k_b + 1 + k_c/k_b} \quad (29)$$

One can also analyze the results in a somewhat different way using a mechanism involving two different types of ion pair intermediates. This is essentially the same type of analysis used by Goering (6) in treating the data for p-chlorobenzhydryl p-nitrobenzoate in aqueous acetone. By using O<sup>18</sup> scrambling as an indication of total ion pair return and the rate of racemization as an indication of return with racemization, Goering found that addition of a good nucleophile (N<sub>3</sub><sup>-</sup>) essentially excluded all return with racemization (ie.  $k_{\text{rac}} \cong 0$ ). It was reasoned that this indicated that two types of ion pairs were probably present and that the azide ion was capable of trapping the carbonium ion in one of these, which he termed the solvent separated ion pair, but was not able to interfere with return from the other type of ion pair, which he termed the intimate ion pair. Since the thiocarbonates are structurally similar to the p-nitrobenzoates used by Goering, it seems possible that two types of ion pairs may also be present in the



decomposition of these thiocarbonates. Such a mechanism is shown in equation 30 with XXX being the "intimate ion pair" and XXXI the

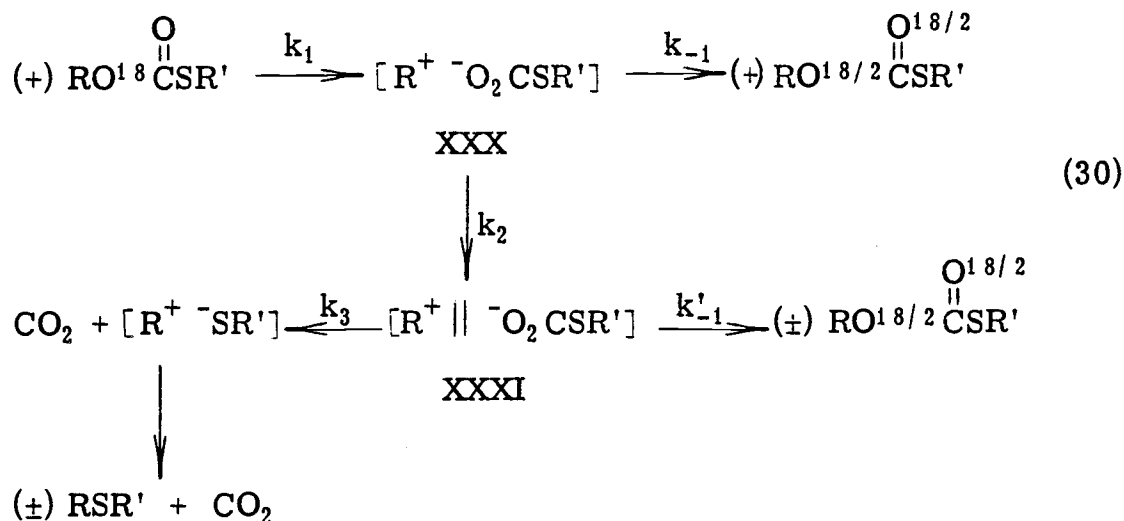

"solvent separated ion pair". In terms of such a mechanism

$$\begin{aligned}
 k_d &= k_1 \left( \frac{k_2}{k_{-1} + k_2} \right) \left( \frac{k_3}{k_3 + k'_{-1}} \right) \\
 k_\alpha &= k_1 \left( \frac{k_2}{k_{-1} + k_2} \right) \\
 k_{\text{eq}} &= k_1 \left( \frac{k_2}{k_{-1} + k_2} \right) \left( \frac{k'_{-1}}{k_3 + k'_{-1}} \right) + k_1 \left( \frac{k_{-1}}{k_{-1} + k_2} \right)
 \end{aligned}$$

From suitable manipulation of these expressions, it is possible to derive that

$$\frac{k_3}{k'_{-1}} = \frac{k_d}{k_\alpha - k_d} \tag{31}$$

and that

$$\frac{k_2}{k_{-1}} = \frac{k_\alpha}{k_{eq} + k_d - k_\alpha} \quad (32)$$

One may now see what application of these two types of analysis to the data obtained in the present study appears to indicate regarding the behavior of the ion pairs formed in the thermal decomposition of thiocarbonates.

Ion Pair Behavior of S-Methyl, S-Cyclohexyl, and S-Phenyl p-Chlorobenzhydryl Thiocarbonates in Benzonitrile. Using equation 24 and 25 to calculate  $k_c/k_b$  and  $k_a/k_b$  and equations 26-28 to calculate the fractions of the total ion pairs following the various pathways in equation 23, the results shown in Table 6 were obtained for the behavior of the various thiocarbonate decompositions in benzonitrile.

TABLE 6. Ion Pair Behavior in Equation 23 for XX, XXIII, and XXVI in Benzonitrile at 145°.

R	Return with Retention (a)	Return with Racemization (b)	Loss of CO <sub>2</sub> (c)
CH <sub>3</sub>	0.54	0.35	0.11
C <sub>6</sub> H <sub>11</sub>	0.50	0.39	0.11
C <sub>6</sub> H <sub>5</sub>	0.72	0.06	0.22

The data shown in Table 6 indicate that in every case the majority of the ion pairs which undergo return to thiocarbonate do so with retention. Notice also that in each case only a rather small fraction of the ion pairs undergo loss of carbon dioxide rather than undergoing return to thiocarbonate. The fraction undergoing loss of carbon dioxide is largest for the case where  $R' = C_6H_5$ , and this is as expected, since the stability of  $RS^-$  in this case, due to resonance stabilization of the negative charge by the aromatic ring, should make loss of carbon dioxide occur more readily than in the other two cases. Note that the increase in the fraction of ion pairs undergoing loss of carbon dioxide for the S-phenyl compound comes entirely at the expense of a decrease in the fraction undergoing return with racemization, since the fraction undergoing return with retention of configuration is actually larger for the S-phenyl ester than for the two S-alkyl compounds.

In his study of ion pair return accompanying the solvolysis of p-chlorobenzhydryl p-nitrobenzoate in aqueous acetone, Goering found that the addition of sodium azide to the system led to the suppression of all of the ion pair return occurring with racemization but had no effect on that portion of the return which occurred with retention of configuration. Since return with retention was essentially unaffected by addition of the trapping agent, Goering assumed, as has been discussed earlier, that two different types of ion pairs were present. The experimental evidence, coupled with Grunwald's

calculations (8) showing the potential energy of ion pairs as a function of the distance of separation of the ions in a solvent with a moderate dielectric constant, suggested that in one type of ion pair (the so-called intimate ion pair) the distance of separation between the ions is quite small so that there are strong electrostatic interactions between the ions. Hence it is not surprising that such an ion pair once formed might undergo a return to covalency with essentially complete retention of configuration. In the other type of ion pair (the so-called solvent separated ion pair), the ions are separated by a greater distance. As a result, the cation (carbonium ion) can be trapped by anionic scavengers like azide ion. The greater distance of separation of the ions would also mean that return to covalency will occur with essentially complete racemization.

As can be seen from Table 6, in the thermal decomposition of p-chlorobenzhydryl thiocarbonates, the fraction of ion pairs undergoing return to thiocarbonate with retention is larger than the fraction undergoing return with racemization. This is similar to the behavior regarding the stereochemistry of ion pair return which Goering observed with  $[\text{ArPhCH}^+ \text{ } ^-\text{O}_2 \text{CAr}']$  ion pairs in aqueous acetone. One might accordingly also interpret the behavior of the thiocarbonate decomposition in the same way that Goering interpreted return phenomena in his system, i. e. to assume that return from the first-formed ion pair, XXX, occurs with retention while ion pair return from XXXI occurs with racemization.

If the results of the thiocarbonate studies are analyzed in terms of the scheme shown in equation 30, one arrives, from equations 31 and 32, at the values of  $k_2/k_{-1}$  and  $k_3/k'_{-1}$  for S-methyl, S-cyclohexyl, and S-phenyl thiocarbonates in benzonitrile shown in Table 7.

TABLE 7. Ion Pair Behavior in Equation 30 for XX, XXII, and XXVI in Benzonitrile at 145°.

R	$k_2/k_{-1}$	$k_3/k'_{-1}$
CH <sub>3</sub>	0.85	0.33
C <sub>6</sub> H <sub>11</sub>	1.00	0.27
C <sub>6</sub> H <sub>5</sub>	0.38	3.5

The value of 0.85 for  $k_2/k_{-1}$  for the S-methyl ester indicates that in that case return to covalency from the intimate ion pair ( $k_{-1}$ ) occurs at a rate comparable to the rate ( $k_2$ ) at which this ion pair goes over to the solvent separated ion pair ( $[R^+ || ^-O_2 CSR']$ ). Return from this second ion pair is favored over loss of carbon dioxide by a factor of about three to one, presumably due to the relatively low stability of CH<sub>3</sub>S<sup>-</sup>. In the case of the S-phenyl ester, loss of carbon dioxide becomes faster by a factor of ten than return to thiocarbonate for the second type of ion pair, but now the ratio of the rate of return to thiocarbonate from the intimate ion pair as compared to the rate of the  $k_2$  step is significantly larger than it

was for the S-methyl compound. While the much larger value of  $k_3/k'_{-1}$  for the S-phenyl ester compared to the S-methyl compound is not surprising considering the greater stability of the ion  $C_6H_5S^-$  compared to  $CH_3S^-$ , the significant difference in  $k_2/k_{-1}$  for the S-phenyl and S-methyl esters was unexpected. In considering possible explanations for it, one of the first thoughts was that the racemization of the initial ion pair (step  $k_2$ ) might be sensitive to the steric bulk of the R' group in  $R'SCO_2^-$ , the larger R', the slower  $k_2$ . If  $k_{-1}$  is not significantly dependent on the nature of R', this would have the effect of making  $k_2/k_{-1}$  smaller for the S-phenyl ester than for the S-methyl compound.

A cyclohexyl group is approximately the same size as a phenyl group. Therefore, if this explanation were correct, one would expect that  $k_2/k_{-1}$  for the S-cyclohexyl compound should also be significantly smaller than  $k_2/k_{-1}$  for the S-methyl ester. However, as one can see from Table 7, this is not the case. For this reason, the above explanation for the smaller value of  $k_2/k_{-1}$  for the S-phenyl compound does not seem to be valid. What then is the cause of the smaller  $k_2/k_{-1}$  value for the S-phenyl compound?

There seem to be two possible explanations, and at present one cannot be sure which is the correct one. The first of these suggests that in the intimate ion pair in the S-phenyl case, there is some interaction between the phenyl group attached to the sulfur and the aromatic rings of the aralkyl carbonium ion. Simple molecular models show that it is possible for the phenyl group in

$\text{C}_6\text{H}_5\text{SCO}_2^-$  to be close enough for the  $\pi$ -cloud to interact with one of the aromatic groups on the carbonium ion (XXXIII).

White's study (17) of the deamination of secondary and tertiary carbinamines lends support to the idea that one important way that carbonium ion-anion ion pairs may "racemize" is via a rotation in the carbonium ion about an axis through the center of mass of the cation. By using the  $\text{O}^{18}$  labeled nitrosoamide of the optically active amine, the effect of size of  $\text{R}_1$ ,  $\text{R}_2$  and  $\text{R}_3$  on the extent of racemization and  $\text{O}^{18}$  scrambling in the ion pair XXXII (equation 33) was studied. When  $\text{R}_1 = \text{CH}_3$ ,  $\text{R}_2 = \text{H}$ , and  $\text{R}_3 = \text{C}_6\text{H}_5$ ,

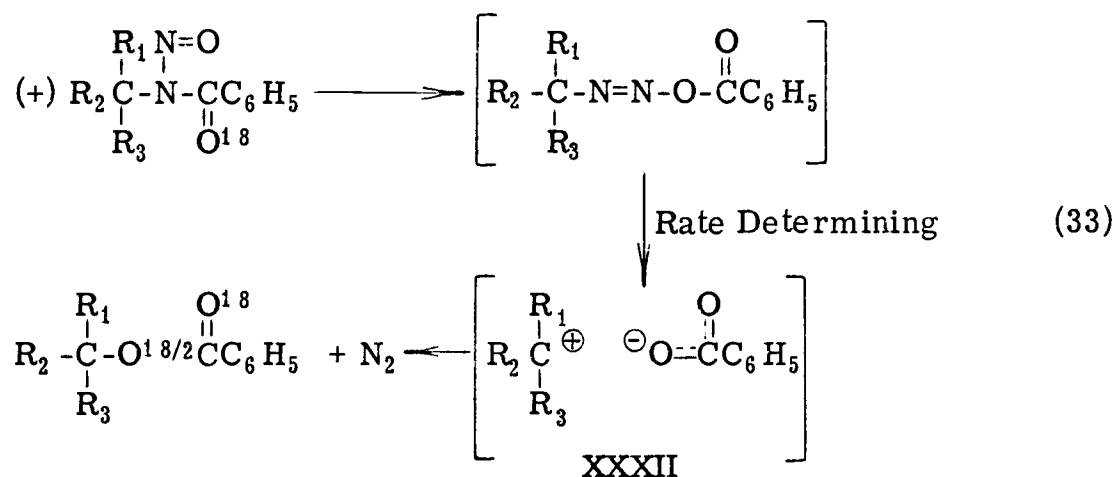

the deamination occurred with 73-83 percent retention and 54-59 percent  $\text{O}^{18}$  remaining in the carbonyl position. When  $\text{R}_1 = \text{CH}_3$ ,  $\text{R}_2 = \text{CH}_2\text{CH}_3$ , and  $\text{R}_3 = \text{C}_6\text{H}_5$ , the decomposition gave ester of essentially completely retained configuration but with about the same amount of  $\text{O}^{18}$  remaining in the carbonyl position (63-65 percent). White reasoned that since  $\text{O}^{18}$  scrambling in the carboxylate

ion was independent of the alkyl group, the greater retention of configuration found in the case of the tertiary carbinamine relative to the secondary carbinamine was consistent with the idea that the larger the groups attached to the cationic carbon of the carbonium ion, the slower the rate of rotation of the ion about an axis through the center of mass of the cation and the higher the degree of retention of configuration in the ester product from the collapse of XXXII to covalency.

If a  $\pi$ -interaction of the type shown in XXXIII were to exist in the initial ion pair from the decomposition of the S-phenyl thio-carbonate it could have the effect of hindering rotation of the

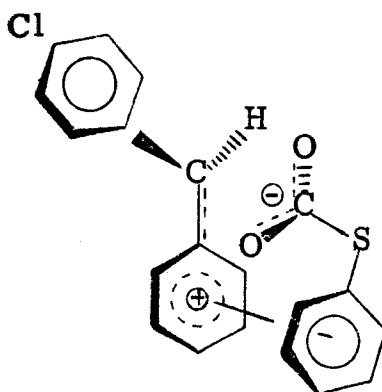

XXXIII

carbonium ion. If racemization of the ion pair occurs principally as a result of such a rotation, this will mean that the  $k_2$  step would be slower for the S-phenyl compound than for the other esters thus making  $k_2/k_{-1}$  smaller than in those other cases.

An alternate possible explanation for the lower value of  $k_2/k_{-1}$  for the S-phenyl ester would seem to be the following.



In Goering's study of the solvolysis of p-chlorobenzhydryl p-nitrobenzoate, he assumed that the return of every ion pair  $[\text{ArPhCH}^+ \text{ } ^-\text{O}_2 \text{CAr}']$  to ester was accompanied by  $\text{O}^{18}$  scrambling between carbonyl and ether oxygens. In other words he assumed that  $k_{\text{eq}}$  was a valid measure of the total rate of ion pair return since he felt that both oxygens should be exactly equivalent in the carboxylate ion. However, work by Diaz and Winstein (1) on the reaction of diphenyl diazomethane with molecular benzoic acid in ethanol casts some doubt on whether the two oxygens do become exactly equivalent in the carboxylate anion. Diaz and Winstein generated essentially the same  $[(\text{C}_6\text{H}_5)_2 \text{CH}^+ \text{ } ^-\text{O}_2 \text{CC}_6\text{H}_5]$  ion pairs as Goering studied by reaction of diphenyl diazomethane with benzoic acid (equation 34). The formation of ester was used a means of measuring ion pair return to covalency in equation 34 and  $\text{O}^{18}$

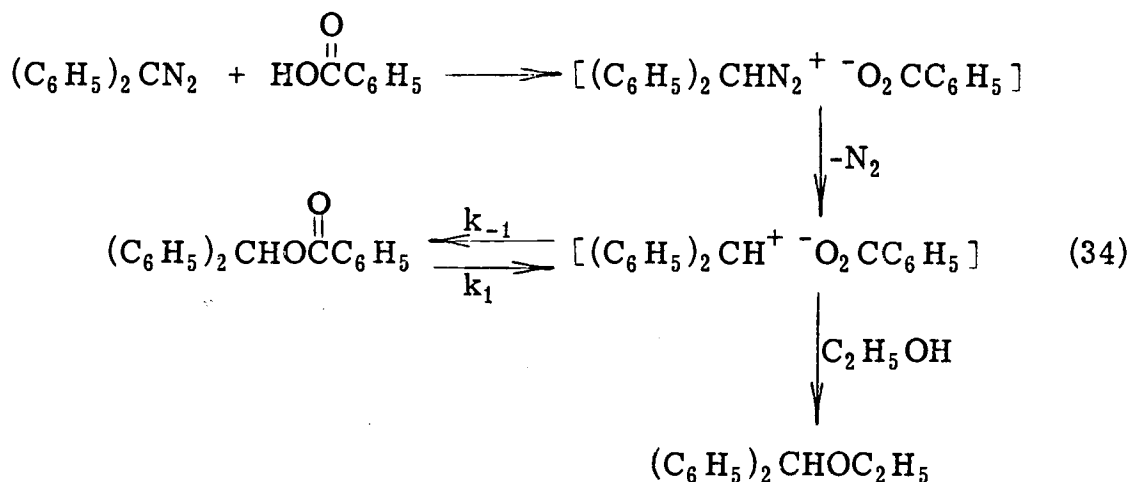

scrambling was used to measure the return of ion pairs formed in equation 35. The fraction of those ion pairs which collapsed to

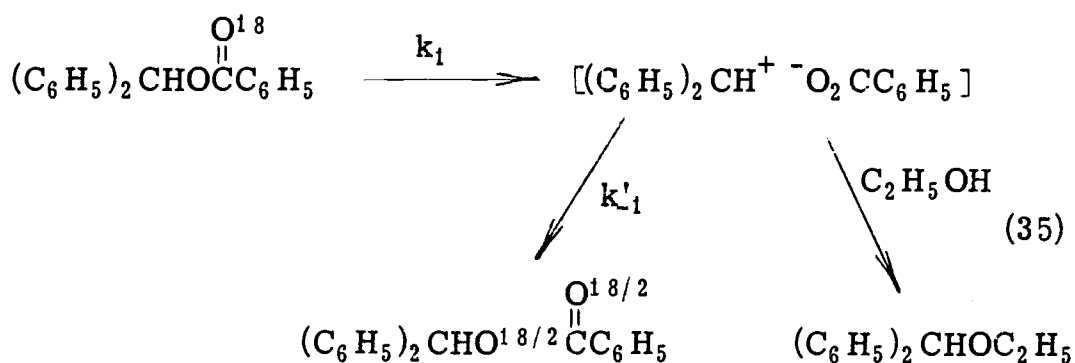

ester via  $k_{-1}$  as contrasted to those undergoing solvolysis was compared with the fraction of ion pair return via  $k'_{-1}$  accompanying the solvolysis of benzhydryl benzoate as indicated by  $\text{O}^{18}$  scrambling (equation 35). A larger fraction (0.558, compared to 0.47) of the ion pairs generated in equation 34 gave ester than would have been expected on the basis of the  $\text{O}^{18}$  scrambling rate for benzhydryl benzoate. The simplest interpretation of this result is that the  $\text{O}^{18}$  scrambling is not giving a true value for ion pair return, in other words that some ion pairs return without equilibration of  $\text{O}^{18}$  between ether and carbonyl oxygens.

This same conclusion is also indicated by a study by White and Elliger (18) of the decomposition of  $\text{O}^{18}$  labeled nitrosoamide of benzhydryl amine (XXXIV) in the same solvent as above (equation 36). This decomposition gave as a product benzhydryl benzoate in which 60 percent of the  $\text{O}^{18}$  label was in the carbonyl group. Since the nitrosoamide decomposition is known to lead eventually to the same ion pair  $[(\text{C}_6\text{H}_5)_2\text{CH}^+ \text{ } ^-\text{O}_2\text{CC}_6\text{H}_5]$  as the one involved in the experiments of Diaz and Winstein and since the benzhydryl benzoate

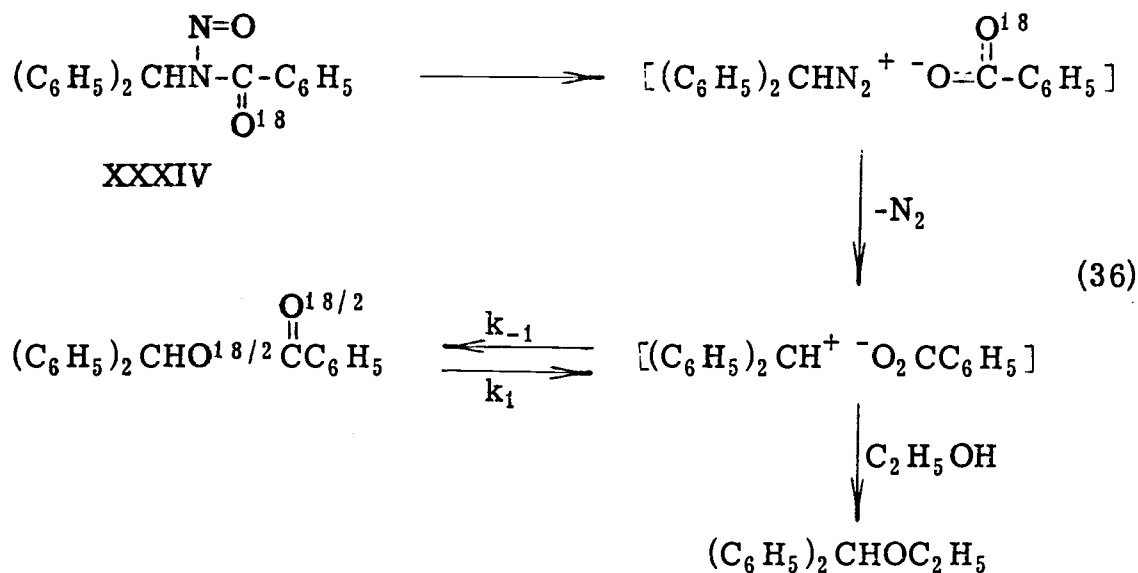

formed as a product comes from collapse of this ion pair to covalency, the fact that more than 50 percent of the original  $\text{O}^{18}$  label is found in the carbonyl group of the ester shows clearly that the two oxygens are not exactly equivalent in the carboxylate anion in the ion pair. It therefore confirms the conclusion reached by Diaz and Winstein that some of the ion pair return accompanying the solvolysis of  $(\text{C}_6\text{H}_5)_2\text{CHO}^{18}\overset{\text{O}^{18}}{\parallel}\text{CC}_6\text{H}_5$  occurs without  $\text{O}^{18}$  equilibration.

It is therefore apparent that in the initial stages of its lifetime, the two oxygens in the carboxylate anion of an ion pair  $[\text{R}^+ \text{ } ^-\text{O}_2\text{CAr}]$  are not completely equivalent. For this reason, the apparent rate of return from the intimate ion pair,  $k_{-1}^{\text{app}}$ , as determined from  $k_{\text{eq}}$ , will probably generally be smaller than the true value of  $k_{-1}$ .

If in the thiocarbonate decompositions lack of equilibration of  $O^{18}$  occurs to a greater extent for return from the intimate ion pairs for the S-methyl and S-cyclohexyl esters than for the ion pair from the S-phenyl ester, one can easily see how  $k_2/k_{-1}$  in Table 7 for these esters, which is in reality  $k_2/k_{-1}^{app}$ , will be larger than  $k_2/k_{-1}$  for the S-phenyl ester. The key question then becomes is there any reason that lack of equilibration of  $O^{18}$  should occur to a greater extent for return from  $[ArPhCH^+ \ ^-O_2 CSR']$  when  $R' = CH_3$  or  $C_6H_{11}$  than when  $R' = C_6H_5$ ?

In this connection the situation is not entirely clear cut. The anion  $C_6H_5SCO_2^-$  is almost certainly somewhat more stable than either  $CH_3SCO_2^-$  or  $C_6H_{11}SCO_2^-$  (pKa of  $C_6H_5CH_2COOH = 4.28$  against pKa of  $CH_3CH_2COOH = 4.78$ ). If this increased stability has the effect of causing the two oxygens in the carboxylate portion of  $[ArPhCH^+ \ ^-O_2 CSR']$  to become more nearly equivalent then the behavior of  $k_2/k_{-1}^{app}$  is indeed as expected. However, at present it is not clear that the small difference in the stability of the different anion should a priori have such an effect, although it is, at the same time, entirely possible that it does. However, because of the clear evidence from the work of others that the oxygens of a carboxylate ion in an intimate ion pair are often not exactly equivalent, this explanation for the variation in the  $k_2/k_{-1}$  values in Table 7 certainly has to be considered as seriously, if not more so, than the explanation involving the  $\pi$ -interactions.

At present, there seems to be no simple means of differentiating the two explanations. If one uses an aryl ring for R' in  $R'SCO_2^-$  which should form a stronger  $\pi$ -complex with the aryl rings of the carbonium ion, this also changes the stability of the  $R'SCO_2^-$  anion. As noted above, in view of White's results (18) in which the carboxylate oxygens were shown to be non-equivalent, the explanation involving the dependence upon the stabilities of  $R'SCO_2^-$  probably is the preferred current explanation of the dependence of  $k_2/k_{-1}$  on structure. However, the alternate explanation is clearly also one that must still be given serious consideration.

Ion Pair Behavior of S-Methyl and S-Phenyl p-Chlorobenzhydryl Thiocarbonates in Bromobenzene. When the thermal decomposition of S-methyl and S-phenyl thiocarbonates is studied in a less polar solvent, a significant decrease in rate is found (see Results). This is presumably due to the inability of the solvent to stabilize the ionic species formed in the decomposition. Calculation of the fraction of ion pairs following each of the various pathways is not possible since  $k_\alpha$  was not determined in bromobenzene. However,  $k_d$  and  $k_{eq}$  were determined and thus information concerning total ion pair return in bromobenzene is available.

The same method of calculating ion pair return as shown in equations 27-29 was used. However, since only total ion pair return is being measured ( $k'_a$  in equation 37), the expressions shown

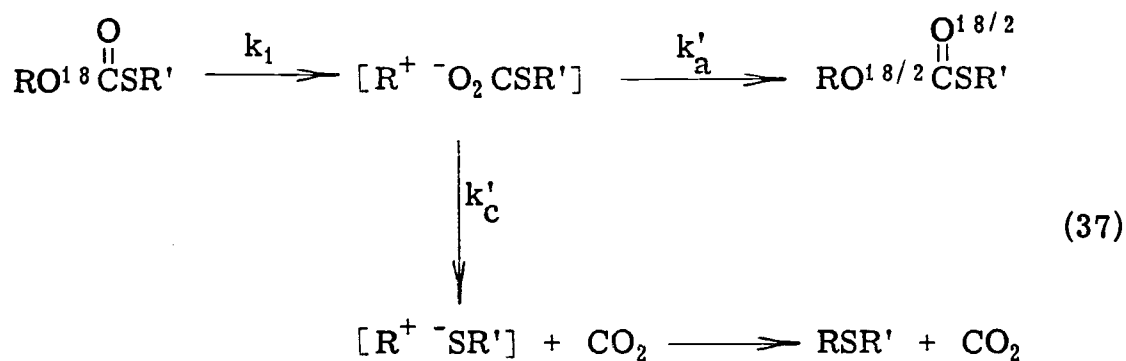

in equation 38 are used instead of the ones shown in equation 24.

$$k_d = k_1 \left( \frac{k'_c}{k'_a + k'_c} \right)$$

$$k_{\text{eq}} = k_1 \left( \frac{k'_a}{k'_a + k'_c} \right)$$

$$\frac{k'_a}{k'_a + k'_c} = \frac{1}{1 + k_d/k_{\text{eq}}} \tag{38}$$

The fraction of ion pairs losing carbon dioxide is given by equation 39.

$$\frac{k'_c}{k'_a + k'_c} = \frac{k_d/k_{\text{eq}}}{1 + k_d/k_{\text{eq}}} \tag{39}$$

The results of such calculations for both S-methyl and S-phenyl thiocarbonates in both benzonitrile and bromobenzene are shown in Table 8.

TABLE 8. Ion Pair Return versus Loss of Carbon Dioxide for XX and XXVI in Benzonitrile and Bromobenzene.

R'	Temp., (°C)	Solvent	Total Return (a')*	Loss of CO <sub>2</sub> (c')
CH <sub>3</sub>	145	Benzonitrile	0.89	0.11
C <sub>6</sub> H <sub>5</sub>	145	Benzonitrile	0.78	0.22
CH <sub>3</sub>	155	Bromobenzene	0.95	0.05
C <sub>6</sub> H <sub>5</sub>	145	Bromobenzene	0.89	0.11

\*Includes both return with retention and return with racemization.

Since the activation energy for both  $k'_a$  and  $k'_d$  is undoubtedly small compared to the activation energy for  $k_1$ , the fact that the decomposition of the S-methyl thiocarbonate was studied at 155° in bromobenzene rather than at the 10° lower temperature used for all the other studies should be of little significance.

The results in Table 8 show that in a less polar solvent, ion pair return is occurring to a considerably greater degree than in benzonitrile. However, as was true in benzonitrile, the greater stability of the C<sub>6</sub>H<sub>5</sub>S<sup>-</sup> anion results in a larger fraction of ion pairs from the S-phenyl ester losing carbon dioxide than in the decomposition of the S-methyl thiocarbonate. It is interesting to note that the rate of loss of carbon dioxide in the S-methyl thiocarbonate is very small compared to the rate of return to covalency (a ratio of

19 to 1). This shows that the ability of the solvent to stabilize the  $[R^+ \text{ } ^-SR']$  ion pair is indeed less in bromobenzene than in benzonitrile.

Future experimental work was planned for determining  $k_{rac}$  in bromobenzene for S-methyl and S-phenyl thiocarbonates but this was not possible due to difficulties in obtaining the optically active starting material.





ester. Since the S-cyclohexyl thiocarbonate gave values of  $k_3 / k'_{-1}$  and  $k_2 / k_{-1}$  comparable to the S-methyl thiocarbonate, the difference is not due to the increased steric bulk of the R' group.

The unexpected behavior of  $k_2 / k_{-1}$  could be due to either of two causes: (1) In the case of the S-phenyl ester there may be a  $\pi$ -complex type interaction in the intimate ion pair between the phenyl ring in the anion and those of the carbonium ion. This could lead to a decreased rate of racemization ( $k_2$ ) for the ion pair from the S-phenyl ester. (2) The carboxylate oxygens may not become completely equivalent in the intimate ion pair with the result that  $k_{eq}$  gives an apparent value of  $k_{-1}$  which is appreciably lower than the true value. If this effect is more important for the S-methyl than the S-phenyl thiocarbonate this could also lead to a variation in  $k_2 / k_{-1}$  with ester structure of the type observed. Unfortunately, current experimental methods provide no simple means by which this matter may be resolved.

Further study of the thiocarbonate decomposition in bromobenzene is needed before the complete calculation of ion pair return in this solvent can be done. However, relative to the results in benzonitrile the total return compared to the loss of carbon dioxide for the S-methyl and S-phenyl esters is consistent with the trends that would have predicted in advance for a change to a solvent of lower ionizing power.

## EXPERIMENTAL

Preparation of p-Chlorobenzhydryl S-Methyl Thiocarbonate (XX).

This was prepared using the method of Kice and coworkers (10). Into a three-necked flask, fitted with a dropping funnel and magnetic stirrer, was placed 3.4 g. (0.016 mole) of p-chlorobenzhydrol, 2.6 g. (0.032 mole) of pyridine, and 36 ml. of benzene. After the solid dissolved, 2.2 g. (0.020 mole) of methyl chlorothioformate in 12 ml. of benzene was added dropwise. The mixture was stirred for 24 hours at room temperature, then washed with water two times and once with saturated sodium chloride solution. Fifty ml. of ether was added during the first washing to prevent emulsification of the organic layer. The organic layer was dried over Drierite. After filtering the solution and removing the solvent under reduced pressure, the crude product was chromatographed on 50 g. of alumina (activity I-II), using 4:1 hexane:benzene as eluent. Removal of the eluent from the fractions led to oils which were crystallized and recrystallized from hexane, yielding 2.3 g. (59%) of pure XX, m.p. 62-63°.

Preparation of p-Chlorobenzhydrol-O<sup>18</sup>. 4-Chlorobenzophenone

(150 g., 0.69 mole) was dissolved in a mixture of 700 ml. of dioxane, 50 ml. (2.8 mole) of oxygen-18 enriched water (1.59%), and 0.1 ml. of concentrated sulfuric acid. This mixture was heated under reflux conditions for 24 hours. The major portion of solvent

was distilled off and the residue was dissolved in 200 ml. of ether and dried over magnesium sulfate. After filtering, the solution was added dropwise with stirring to a three-necked flask fitted with a reflux condenser and containing 15 g. (0.4 mole) of lithium aluminum hydride and 200 ml. of anhydrous ether. The mixture was stirred overnight at room temperature. It was then cooled in an ice-salt bath and saturated ammonium chloride solution was added very carefully. After no further reaction was observed, 300 ml. of 10% ammonium chloride solution was added to break up the emulsion. The organic layer was washed two times with water and once with saturated sodium chloride solution; it was then dried over Drierite. The ether was removed under reduced pressure, and the resulting solid was recrystallized from hexane yielding 143 g. (95%) of p-chlorobenzhydrol-O<sup>18</sup> (1.42% O<sup>18</sup>), m.p. 65°.

Preparation of Alkyl-O<sup>18</sup> S-Methyl p-Chlorobenzhydryl Thiocarbonate (XXII). Employing the same techniques described for the preparation of XX, 6.7 g. (0.06 mole) of methyl chlorothioformate in 25 ml. of benzene was added to 90 ml. of benzene containing 8.0 g. (0.04 mole) of p-chlorobenzhydrol-O<sup>18</sup> and 8.0 g. (0.10 mole) of pyridine. The impure product was chromatographed on alumina, with 4:1 hexane:benzene as eluent. The oils resulting after removal of the solvent at reduced pressure were crystallized and recrystallized from hexane. A yield of 5.6 g. (53%) of pure oxygen-18 enriched XXII (1.41% at the alkyl oxygen), m.p. 62.5-63.0°, was obtained.

Preparation of p-Chlorobenzhydryl S-Cyclohexyl Thiocarbonate

(XXIII). Using the same method as described in the preparation of XX, 2.2 g. (0.01 mole) of p-chlorobenzhydrol, 0.90 g. (0.012 mole) of pyridine, and 2.2 g. (0.012 mole) of cyclohexyl chlorothioformate were stirred in 4 ml. of benzene for 6 hr. at room temperature to give the crude product. The material was purified by chromatography on alumina and the fractions containing thiocarbonate were again chromatographed on alumina to yield 0.81 g. (20%) of pure XXIII which could not be crystallized.

Analysis: Calculated for  $C_{20}H_{21}O_2SCl$ , C: 66.64, H: 5.86; found C: 66.75 and H: 5.93.

Preparation of (+) p-Chlorobenzhydryl S-Cyclohexyl Thiocarbonate

(XXIV). Again employing the same techniques used in the preparation of XX, 1.0 g. (4.6 mmole) of (-) p-chlorobenzhydrol ( $\alpha]_D = (-) 1.7^\circ$ ), 0.46 g. (5.9 mmole) of pyridine, and 1.1 g. (6.1 mmole) of cyclohexyl chlorothioformate were stirred for 6 hr. in 1.0 ml. of benzene. The crude product was chromatographed two times on alumina to give 0.45 g. (27%) of XXIV,  $\alpha]_D = (+) 0.116^\circ$ , which had less than 5 percent impurities as determined by thin layer chromatography techniques.

Preparation of Alkyl-O<sup>18</sup> p-Chlorobenzhydryl S-Cyclohexyl Thiocarbonate (XXV).

Utilizing the method described in the preparation of XX, 8.8 g. (0.040 mole) of p-chlorobenzhydrol-O<sup>18</sup> (1.19% O<sup>18</sup>),

3.6 g. (0.048 mole) of pyridine, and 8.5 g. (0.050 mole) of cyclohexyl chlorothioformate in 12 ml. of benzene were stirred 6 hr. at room temperature. The resulting material was chromatographed on alumina to yield 5.1 g. (46%) of product (95% pure) with 1.19 percent  $O^{18}$  at the alkyl oxygen position.

Preparation of p-Chlorobenzhydryl S-Phenyl Thiocarbonate (XXVI).

Again using the technique described for the preparation of XX, 2.1 g. (0.01 mole) of p-chlorobenzhydrol, 2.1 g. (0.03 mole) of pyridine in 40 ml. of benzene, and 2.2 g. (0.02 mole) of phenyl chlorothioformate in 10 ml. of benzene were reacted, yielding the crude thiocarbonate. The resulting liquid was chromatographed on alumina with 5:1 hexane:benzene as eluent. Subsequent removal of the solvent from the fractions yielded oils which, upon crystallization and recrystallization from hexane gave 1.1 g. (29%) of pure XXVI, m.p.  $95^{\circ}$ .

Preparation of (+) p-Chlorobenzhydryl S-Phenyl Thiocarbonate

(XXVII). Employing the same techniques indicated for the preparation of XX, 1.47 g. (6.7 mmole) of (-) p-chlorobenzhydrol ( $[\alpha]_D = -4.0^{\circ}$ ), 1.4 g. (18 mmole) of pyridine, 27 ml. of benzene, and 1.4 g. (8.2 mmole) of phenyl chlorothioformate in 7 ml. of benzene were reacted to give the crude product. Chromatography on alumina with 5:1 hexane:benzene as eluent produced oils which crystallized overnight under vacuum. The purified thiocarbonate was recrystallized from hexane yielding 0.70 g. (27%) of XXVII which had a

melting point of 92-93° and specific rotation in hexane of  $[\alpha]_{365} = + 0.798^\circ$ .

Preparation of Alkyl-O<sup>18</sup> S-Phenyl p-Chlorobenzhydryl Thiocarbonate (XXVIII). Utilizing a variation of the procedure given for the preparation of XX, 11.0 g. (0.05 mole) of p-chlorobenzhydryl-O<sup>18</sup>, 4.6 g. (0.06 mole) of pyridine, 20 ml. of benzene and 10.4 g. (0.06 mole) of phenyl chlorothioformate were combined and reacted 7 hr. to produce the crystalline crude thiocarbonate. It was not necessary to chromatograph the material as treatment of the hexane solution with decolorizing charcoal and recrystallization from hexane led to 12.0 g. (67%) of pure XXVIII, m.p. 95-96°.

Preparation of (+) p-Chlorobenzhydryl Hydrogen Phthalate. Employing the procedure of Kenyon and Green (7), 15 g. (0.10 mole) of phthalic anhydride in 10 g. (0.13 mole) of boiling pyridine was rapidly cooled to 50° and 20 g. (0.09 mole) of p-chlorobenzhydryl was added with vigorous stirring. After standing overnight at room temperature, the mixture was heated at 60° for 2 hours, then it was dissolved in acetone. The crude product which separated when the acetone solution was poured into acidic ice-water, was dissolved in ether, and the ether solution was washed once with water. Extraction of the ether layer with sodium bicarbonate solution (5%) and acidification of the aqueous layer with dilute hydrochloric acid provided crystalline product which was recrystallized from benzene: hexane (10:1) to yield 27 g. (76%) pure product, m.p. 151-152°.

Preparation of (-) p-Chlorobenzhydrol. The procedure involved a modification of the one used by Kenyon and Green (7) in which 29.9 g. (0.064 mole) of brucine and 27.8 g. (0.073 mole) of p-chlorobenzhydryl hydrogen phthalate was dissolved in 140 ml. of ethyl acetate. After filtering, the solution was evenly divided between two 250 ml. erlenmeyer flasks seeded with a crystal of brucine p-chlorobenzhydryl hydrogen phthalate from a previous preparation. The flasks were then placed in an air tight container containing approximately 150 ml. of cyclohexane. The container was sealed and placed in a refrigerator. After about three weeks the crystals were removed by suction filtration and the filtrate returned to the container. The combined crops of crystals were dissolved in a minimal amount of acetone and decomposed with cold 3N hydrochloric acid. After adding a large volume of cold water (200 ml.), the resulting (+) p-chlorobenzhydryl hydrogen phthalate was dissolved in ether and the ether solution was extracted with sodium bicarbonate solution (5%). Acidification of the aqueous solution with dilute hydrochloric acid yielded 3.5 g. of purified product. The (+) acid phthalate ester was dissolved in 50 ml. of hot methanol and heated with 5 ml. of 40% sodium hydroxide solution on a steam bath for fifteen minutes. After addition of 150 ml. of water to the cooled mixture, the mixture was extracted twice with ether, and the ether extracts were dried over magnesium sulfate. After removal of the ether, the residual oil was crystallized from hexane to give 1.3 g. of product



with the specific rotation in acetone  $\alpha_D = -4.4^\circ$  and a melting point of  $52-55^\circ$ .

Preparation of Cyclohexyl and Phenyl Chlorothioformate. These compounds were prepared using the method of Kice and coworkers (10). Phosgene (35 g.; 0.35 mole) was dissolved in 300 ml. of toluene. To the mixture, which was kept at  $-5^\circ$  to  $0^\circ$  in a three-necked flask fitted with a Dry-Ice-acetone condenser and ice-salt bath, was added dropwise 0.17 mole of the appropriate mercaptan in 100 ml. of toluene. The mixture was stirred at this temperature for one hour then left overnight. After making the mixture basic with sodium hydroxide solution (6 N), the toluene layer was washed twice with water, once with saturated sodium chloride solution, and then dried over Drierite. After removal of the toluene under reduced pressure, the resulting oil was fractionally distilled. A yield of 17.7 g. (57%) of cyclohexyl chlorothioformate, b.p.  $61-62^\circ / 1 \text{ mm.}$ , and 22.6 g. (77%) of phenyl chlorothioformate, b.p.  $63-64^\circ / 1 \text{ mm.}$ , was obtained.

Preparation of Methyl Chlorothioformate. Using the same procedure as in the preparation of cyclohexyl and phenyl chlorothioformates, 150 g. (1.5 mole) of phosgene was dissolved in 500 ml. of dry ether and cooled to  $-5^\circ$ . Methyl mercaptan (50 g., 0.46 mole) dissolved in 500 ml. of ether was added dropwise. After following the same workup as before, the resulting oil was fractionally distilled to yield 26.6 g. (52%) of pure material, b.p.  $110-111.5^\circ$ .

### Purification of Solvents.

Benzonitrile. Reagent grade benzonitrile was steam distilled and the distillate was extracted with ether. After washing with 5 percent sodium carbonate solution, the ether solution was dried over magnesium sulfate. The ether was removed and the benzonitrile was fractionally distilled under reduced pressure (b.p. 72-75° / 10 mm.). Nitrogen was bubbled through the distillate heated to 160° for 24 hours to remove any volatile impurities. The benzonitrile was then carefully distilled, b.p. 75° / 10 mm..

Bromobenzene. The highest grade commercial product was fractionally distilled, b.p. 155-156°.

### Kinetic Studies of the Thermal Decomposition of XX, XXIII, and

XXVI. The apparatus used for the kinetic studies is shown in Figure 8. The desired amounts of thiocarbonate and solvent (see Results) were placed in the apparatus. After nitrogen was bubbled through the solution for thirty minutes, the apparatus was immersed in a silicone oil constant temperature bath (see Results for bath temperatures). A slow stream of nitrogen was bubbled through the solution during the entire reaction.

After the reaction flask had been in the constant temperature bath for five minutes, a  $t_0$  sample was taken. Other samples were removed at later desired times.

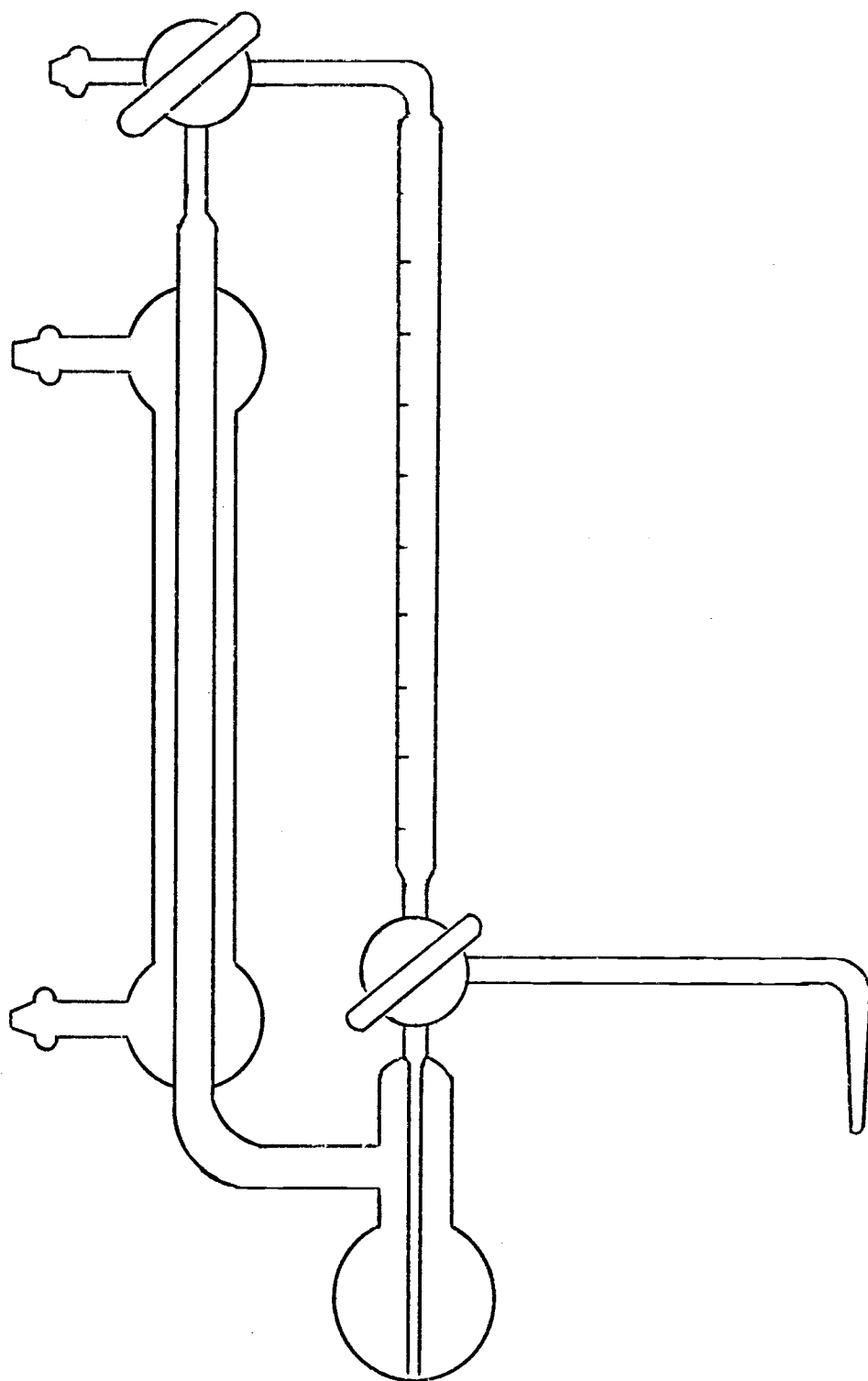

FIGURE 8. Apparatus used for kinetic studies.

The infrared spectra of the samples were examined for absorption over the region 1800-1600  $\text{cm}^{-1}$ . The absorption peak of the carbonyl group of XX and XXVI is at approximately 1710  $\text{cm}^{-1}$ ; that of XXIII is at 1720  $\text{cm}^{-1}$ . Kice and coworkers (10) had previously shown that the intensity of the thiocarbonate ester carbonyl band followed Beer's Law and that a plot of optical density versus concentration of thiocarbonate was linear. Thus, the rate constants were obtained from a plot of the logarithm of optical density against time.

Kinetic Studies of the Equilibration of Alkyl and Acyl Oxygens in the Decomposition of XXII, XXV and XXVIII. The same type of apparatus was used as described in the kinetic studies of the thermal decomposition of the thiocarbonates. A larger apparatus was required since a minimum of approximately 3 mmoles of thiocarbonate per sample was required for effective analysis.

After removal of a sample at the desired time, the solvent was removed at 1-2 mm. pressure, and the residue was dissolved in ether. The ether solution was added to a mixture of lithium aluminum hydride and ether, and the resulting mixture stirred overnight. After cooling in an ice bath, saturated ammonium chloride solution was added very cautiously. The ether layer was washed twice with water, once with saturated sodium chloride solution and then dried over magnesium sulfate or Drierite. The ether was removed under reduced pressure and the crude p-chlorobenzhydrol was crystallized and recrystallized from hexane until a

melting point  $\geq 60^\circ$  was obtained.

The p-chlorobenzhydrol sample was pyrolyzed in Doering's (2) modified oxygen analysis train as shown in Figure 9. The flow of prepurified nitrogen was regulated by the needle valve A and measured with a flow meter (D). The nitrogen was purified further by passing it through a copper-copper oxide scrubber at  $500^\circ$  (B) and any water or carbon dioxide was absorbed in an ascarite-anhydronone trap (C). The sample (15-20 mg.) was placed in a platinum boat and inserted into the pyrolysis tube (E) three inches from the furnace (F). After back purging for fifteen minutes with a flow rate of 20 ml. / min., the flow was reversed and the rate reduced to 10 ml. / min.. The tube behind the sample was slowly heated with a Bunsen burner. The sample was heated to red heat for five minutes and the falme moved forward at the rate of two inches per minute. After passing through the platinized carbon at  $900^\circ$ , the oxygen-18 labeled carbon monoxide was cleaned in an ascarite-anhydronone trap (G) and oxidized to carbon dioxide by iodine pentoxide at  $125^\circ$  in an oven (H). The other oxidation products were removed in an acetone-Dry Ice trap (I). The carbon dioxide-oxygen-18 sample was frozen out in trap J with liquid nitrogen. Trap J was connected to another ascarite-anhydronone trap (K) to prevent contamination by atmospheric carbon dioxide. Trap J was disconnected from the pyrolysis train and evacuated by use of a modified take-off system (L). The sample was allowed to warm up

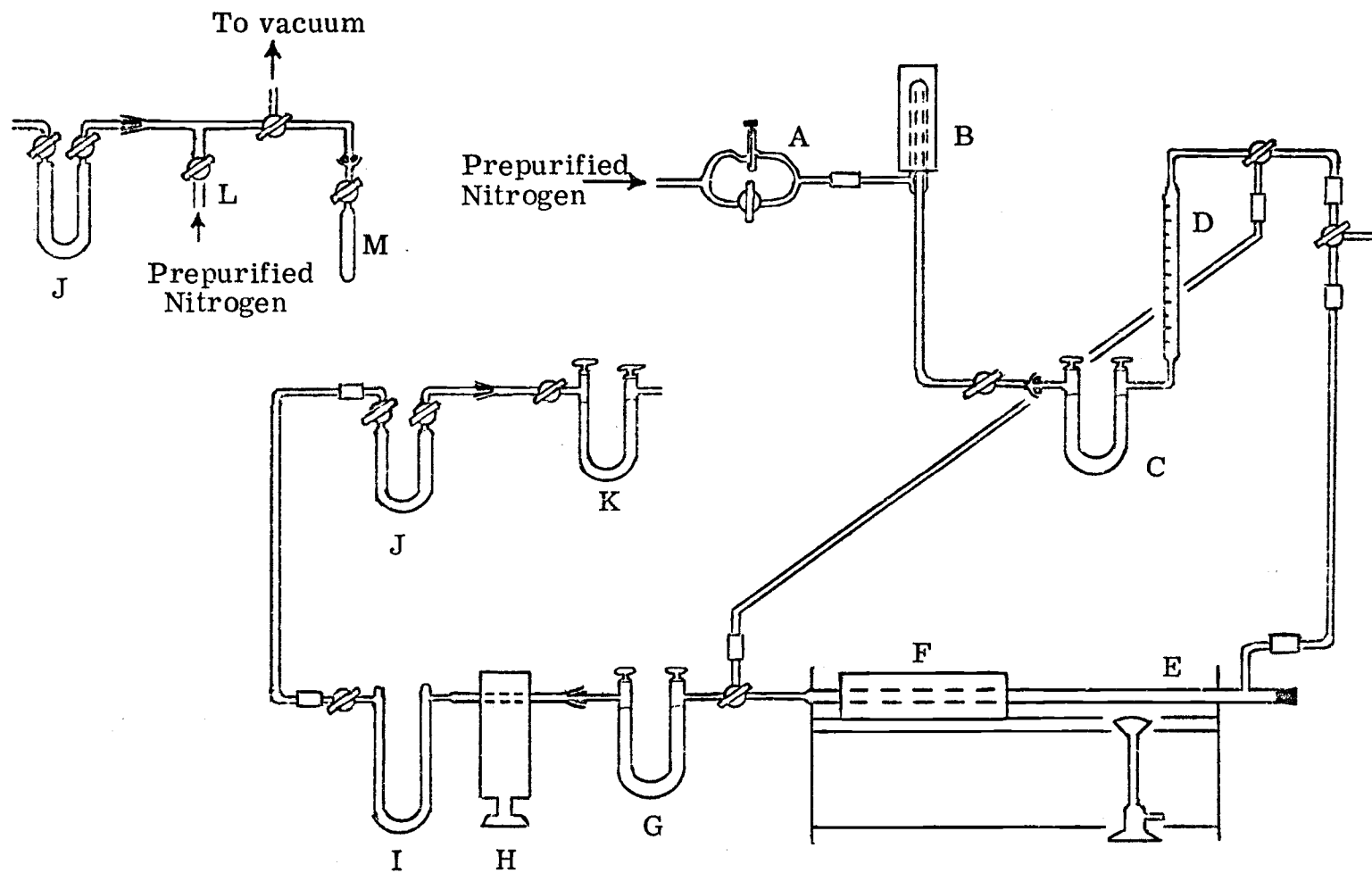

FIGURE 9. Oxygen Analysis Train.

and condensed in tube M with liquid nitrogen. Tube M was attached to the inlet system of a mass spectrometer and the desired amount of carbon dioxide removed.

It was necessary to pyrolyze three or four portions (15-20 mg.) of the sample before any degree of precision was obtained. Three consecutive portions of the sample were pyrolyzed not more than four hours apart. The samples of carbon dioxide enriched in oxygen-18 were analyzed on a CEC residual gas analyzer. The percentage of oxygen-18 (P) in the sample was calculated using the equation 40 devised by Doering (2).

$$P = \frac{(0.00408)(R) - 0.00204}{0.9959 + (0.00408)(R)} \times 100 \quad (40)$$

where

$$R = \frac{I_{46}/I_{44}}{I_{46}^o/I_{44}^o}$$

$I^o$  represents the intensity of the respective mass peak of standard or tank carbon dioxide and  $I$  the intensity of the sample peaks.

The fraction of label on the alkyl oxygen (X) was calculated using equation 41.

$$X = \frac{P - P_{\infty}}{P_o - P_{\infty}} \quad (41)$$

where  $P$  is the percent of oxygen-18 in the sample,  $P_{\infty} = (P_o + 0.204)/2$ , and  $P_o$  is the percent of oxygen-18 at the alkyl oxygen

at zero time. A plot of  $\log X$  against time yielded the rate of equilibration,  $k_{eq}$ .

Kinetic Studies of the Loss of Optical Activity in the Decomposition of XXI, XXIV and XXVII. The apparatus and technique employed was the same as that described in the kinetic studies of the thermal decomposition of the thiocarbonates. After removal of a sample at a desired time, its optical rotation was measured in a polarimeter microcell using a Perkin-Elmer model P-22 polarimeter. The rotations were measured at 400 nm. A plot of  $\log \alpha$  against time was linear. Its slope is equal to  $k_{\alpha}$ .



## BIBLIOGRAPHY

1. Diaz, Arthur F. and S. Winstein. Benzhydryl benzoate ion pairs from diphenyldiazomethane. American Chemical Society, Journal 88:1318-1319. 1966.
2. Doering, W. von E. and Edwin Dorfman. Mechanism of the peracid ketone-ester conversion. Analysis of organic compounds for oxygen-18. American Chemical Society, Journal 75:5595-5598. 1953.
3. Fava, Antonino et al. Isomerization and isotopic exchange of 4,4'-dimethylbenzhydryl thiocyanate in acetonitrile. Partition of electron-deficient intermediates between thio- and iso-thiocyanate. American Chemical Society, Journal 87:1045-1049. 1965.
4. Goering, Harlan L., Robert G. Briody and Jerome F. Levy. The stereochemistry of ion pair return associated with solvolysis of p-chlorobenzhydryl p-nitrobenzoate. American Chemical Society, Journal 85:3059-3061. 1963.
5. Goering, Harlan L. and Jerome F. Levy. The solvolysis and <sup>18</sup>O-equilibration of benzhydryl p-nitrobenzoate-carbonyl-<sup>18</sup>O in aqueous acetone. American Chemical Society, Journal 84:3853-3857. 1962.
6. Goering, Harlan L. and Jerome F. Levy. On the nature of ion pair intermediates involved in the solvolysis of p-chlorobenzhydryl p-nitrobenzoate. American Chemical Society, Journal 86:120-121. 1964.

7. Green, G. H. and J. Kenyon. The resolution of p-chloro-benzhydrol. The Chemical Society, Journal 1950:751-752.
8. Grunwald, Ernest. Interpretation of data obtained in non-aqueous media. Analytical Chemistry 26:1696-1700. 1954.
9. Hammett, Louis P. Physical organic chemistry. New York, McGraw-Hill, 1940. 552 p.
10. Kice, John L. et al. Mechanisms of  $S_Ni$  reactions. The decomposition of aralkyl thiocarbonates. American Chemical Society, Journal 87:1734-1739. 1965.
11. Kice, John L. and Mary A. Dankleff. Mechanisms of  $S_Ni$  reactions. Stereochemical evidence for a two step mechanism for the decomposition of aralkyl thiocarbonates. Tetrahedron Letters 16:1783-1786. 1966.
12. Kice, John L., Fred M. Parham and Robert M. Simons. The thermal decomposition of thiolsulfinates. American Chemical Society, Journal 82:834-842. 1959.
13. Oliver, K. L. and W. G. Young. Allylic rearrangements. XLVI. The thermal decomposition of the butenyl chloroformates. American Chemical Society, Journal 81:5811-5817. 1959.
14. Rhoads, Sara Jane and Robert F. Michel. Decomposition reactions of alkyl chloroglyoxalates. American Chemical Society, Journal 85:585-591. 1963.
15. Smith, Stanley G. Solvolysis of benzhydryl thiobenzoates. A criterion for ionization. Tetrahedron Letters 21:979-982. 1962.

16. Smith, Stanley G., A. H. Fainberg and S. Winstein. Correlation of solvolysis rates. IX. p-Methoxyneophyl toluenesulfonate in a variety of solvents. Ionizing power of hydroxylic and non-hydroxylic solvents. American Chemical Society, Journal 83:618-625. 1961.
17. White, Emil H. and Carl A. Aufdermarsh, Jr. N-Nitrosoamides. V. N-Nitrosoamides of secondary carbinamines; an example of intramolecular inversion of configuration. American Chemical Society, Journal 83:1179-1190. 1961.
18. White, Emil H. and Carl A. Elliger. Benzhydryl benzoate ion pairs and the nitrosoamide decomposition. American Chemical Society, Journal 89:165-167. 1967.
19. Wiberg, Kenneth and Thomas H. Shryne. 1,3-Shifts. IV. The kinetics of the thermal rearrangement of  $\alpha$ -phenethyl chlorocarbonates. American Chemical Society, Journal 77:2774-2778. 1955.
20. Winstein, S. et al. Salt effects and ion pairs in solvolysis and related reactions. III. Common ion rate depression and exchange of anions during acetolysis. American Chemical Society, Journal 78:328-334. 1956.
21. Winstein, S. and G. C. Robinson. Salt effects and ion pairs in solvolysis and related reactions. IX. The threo-3-p-anisyl-2-butyl system. American Chemical Society, Journal 80:169-181. 1958.

22. Young, W. G., S. Winstein and Harlan L. Goering. Allylic rearrangements. XXXII. The solvolysis and intramolecular rearrangement of  $\alpha, \alpha$ -dimethylallyl p-toluenesulfonates. American Chemical Society, Journal 73: 1958-1963. 1951.